

**KAESER**  
**COMPRESSORS**

*Built for a lifetime.™*



# Screw Compressors

## HSD Series (500 - 650 hp)

Capacities from: 1653 to 3044 cfm

Pressures from: 80 to 217 psig

**[kaeser.com](http://kaeser.com)**

# HSD Series

## Built for a lifetime.™

*Kaeser's HSD compressors are engineered to be the cornerstone of any demanding industrial application requiring large volumes of air. Each HSD is two independently operating compressors in a single enclosure. These innovative water-cooled compressor packages provide the energy efficiency of load splitting in a much smaller footprint than two separate compressors of equal capacity. Because each module is a complete compressor, you have all the benefits of built-in redundancy coupled with lower installation costs.*

### Innovation you can trust

With a cutting edge research and development team committed to building industry-leading products, Kaeser continues to deliver better solutions to meet our customers' compressed air needs. Kaeser's expertise and world-wide reputation for superior reliability and efficiency offer great performance and peace of mind.

### Rugged reliability

Kaeser's screw compressors meet our rigorous "built for a lifetime" standard. Designed and built with Kaeser's generations of manufacturing experience, you can rest assured that these compressors will continue to deliver the air you need with the exceptional reliability you expect from a Kaeser compressor.

### Service-friendly

From the ground up, these compressors have been designed with the user in mind. Fewer wearing parts and using premium quality materials ensure reduced maintenance requirements, longer service intervals, and extended service life. A smart component layout with generously sized maintenance doors simplifies service and reduces downtime.

### Guaranteed efficiency

In our systems design approach, Kaeser chooses the components that work together in the most energy efficient way possible. Each and every component — from inlet filter to discharge flange — has been carefully designed with performance in mind. In fact, the HSD series is up to 18% more efficient than the competition. With Kaeser's superior system controls, we guarantee an effective system with lower operating costs.

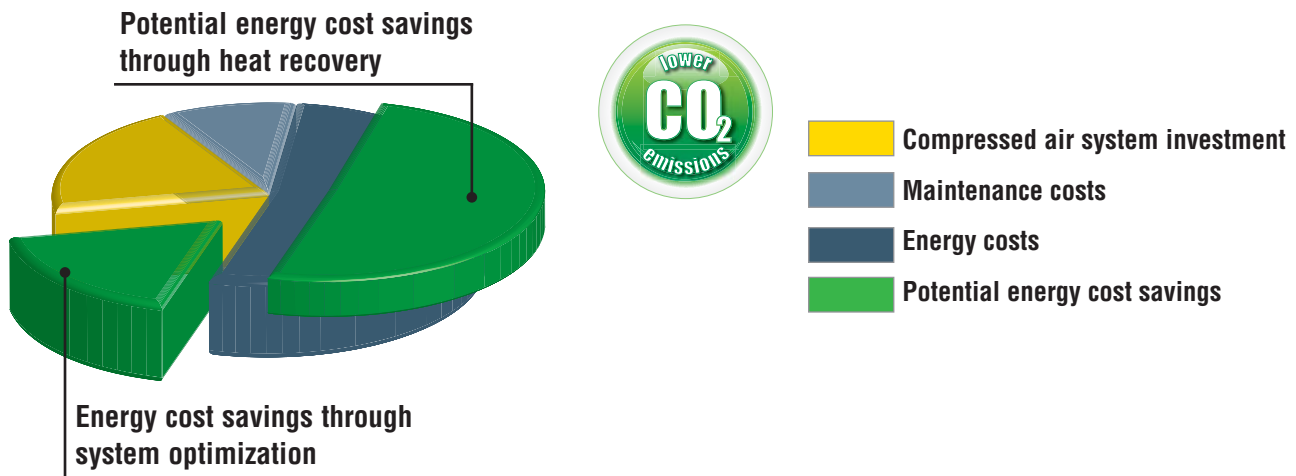



HSD 650 SIGMA

KAESER

HSD 650 SIGMA

KAESER HSD 650 SIGMA

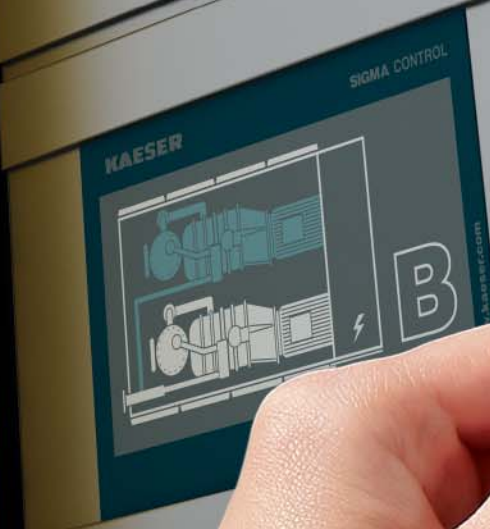
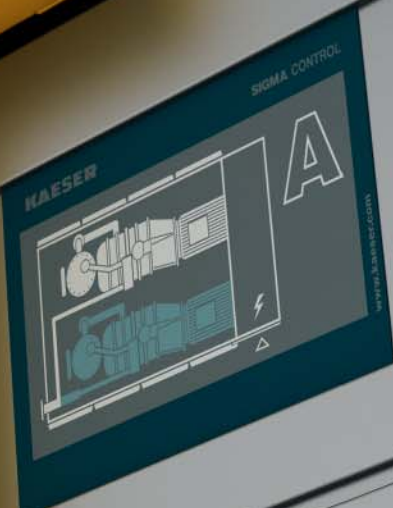

# Energy savings in every detail

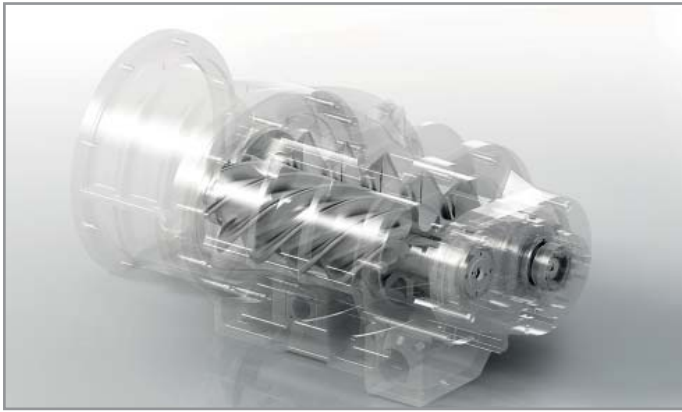

## Sigma Profile™ air end

Our single-stage, flooded rotary screw air end delivers pressures up to 217 psig and features our power saving Sigma Profile™ design. Our air ends are precision machined and optimized in size and geometry to match the air end speeds with their best specific performance. Unlike the competition, Kaeser makes many different air ends so that we can apply them at their optimal speed and performance.



## Intelligent control: Sigma Control 2™

This intelligent controller ensures the most energy efficient compressor operation possible. An RFID sensor provides secure access and simplifies managing maintenance intervals while the SD card slot makes software updates quick and easy. An Ethernet port and built-in web-server facilitate IIoT integration. ModBus, Profinet, Profibus, Devicenet, and other industrial communications interfaces are available as plug-in options for seamless integration into plant control/monitoring systems.



## Super premium efficiency drive motor

Kaeser uses super premium efficiency Totally Enclosed Fan Cooled (TEFC) motors with class F insulation for extra protection from heat and contaminants. Remote grease fittings make maintenance a breeze. Each of the three motor windings is actively monitored through its own Pt100 temperature sensor. Standard voltages are 460 or 575 V (3-phase, 60 Hz). Other voltages are available.



## Electronic Thermal Management system

The innovative Electronic Thermal Management (ETM) system included for each compressor unit dynamically regulates fluid temperature to avoid internal condensation build up, eliminating a common cause of lubricant degradation. It ensures a lower, stable operating temperature which extends air end and cooler life and increases energy efficiency. The ETM has an adjustable temperature setting, making it perfectly suited for heat recovery applications.

# 2-in-1 dependability

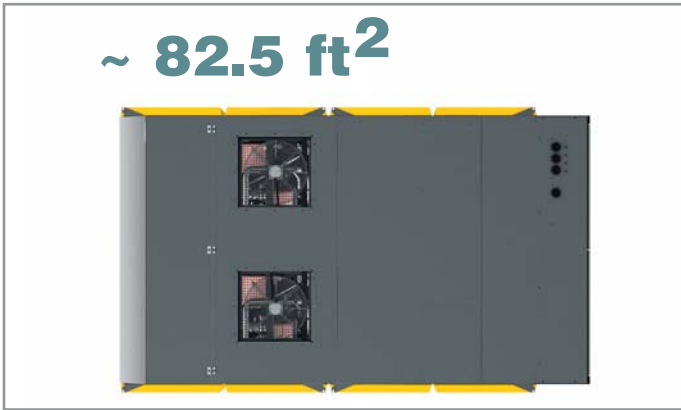

## More compressor, less floor space

Thanks to their water-cooled design, HSD compressors deliver maximum compressor air performance with minimal space requirement. This simplifies the planning process for compressed air systems and reduces the number of required packages—even with high compressed air demand.

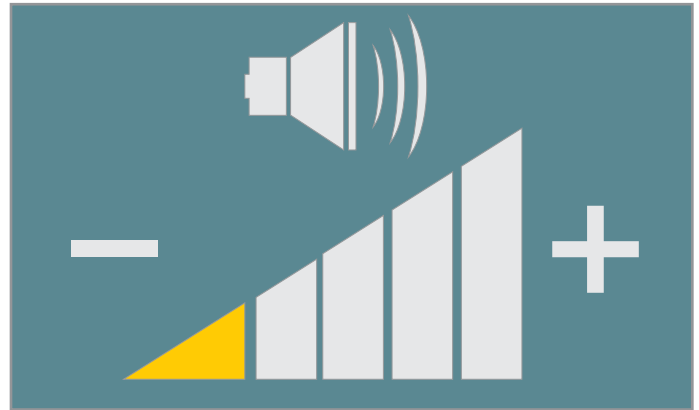

## Quiet performance

A combination of water-cooling and excellent soundproofing mean HSD packages operate with sound levels of only 73 - 75 dB(A). This eliminates the need for additional soundproofing for the compressed air system.



## Double reliability and efficiency

Two complete Sigma Profile™ compressor air ends maximize safety and availability. If one air end is not operating for any reason (e.g. due to maintenance), 50% of the total flow rate is still available. In the master/slave mode, Sigma Control 2™ adjusts the base/peak load switch-over to actual compressed air demand.



## Smart starters

When full flow is needed, the two drive motors start one after the other with a slight delay. This results in a significantly lower load on the plant electrical grid compared to a synchronous start approach.

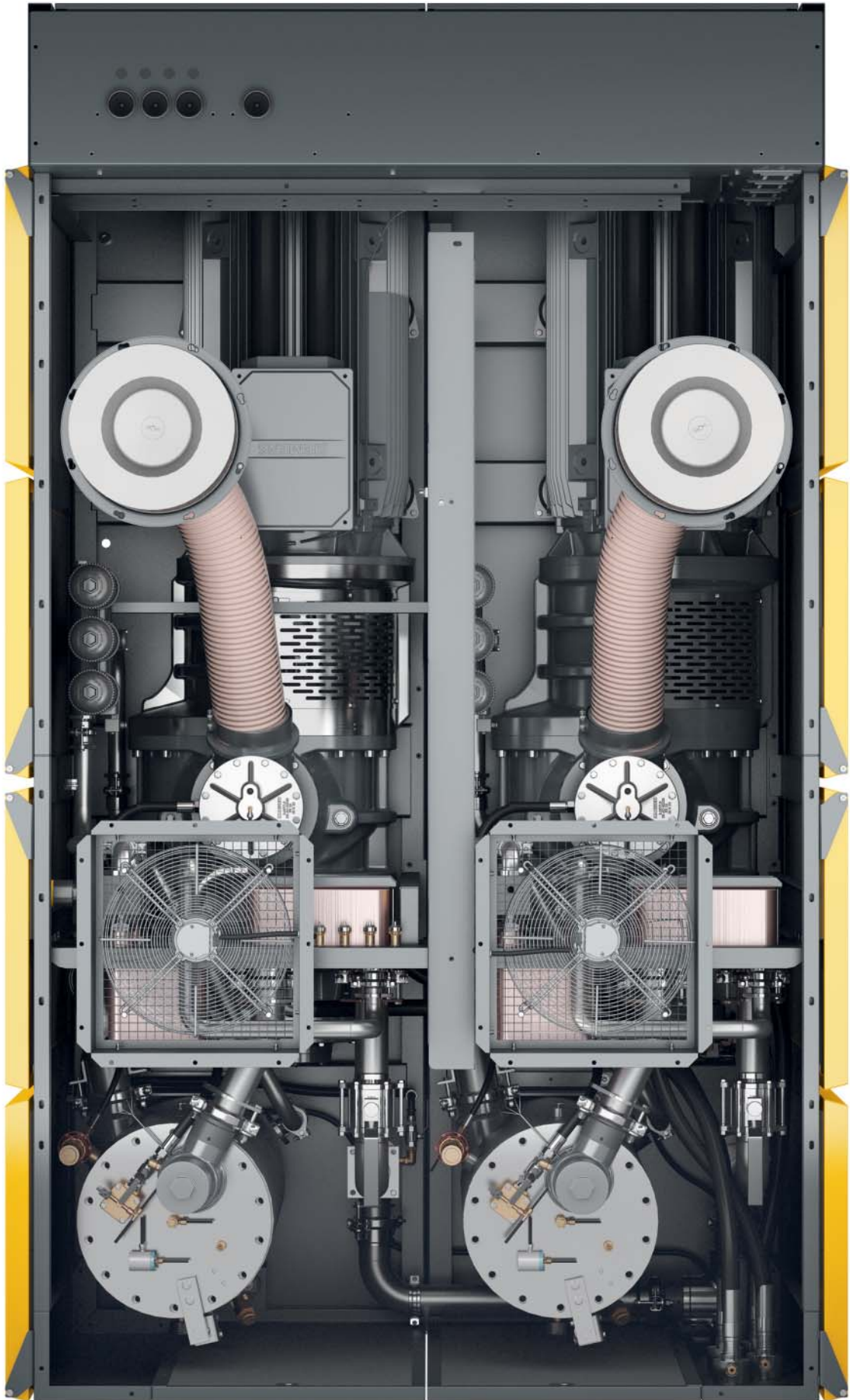





# Efficient in every way



## Optimized inlet valve

The new flow-optimized design of the inlet valve results in lower pressure loss and simplified service. Eliminating a strong compression spring reduces the wear on gaskets and guides while also increasing service safety.



## Integral moisture separator

A moisture separator is integrated into the stainless steel discharge piping. Our unique design maximizes separation with minimal pressure loss—even in high ambient temperatures and humidity. A zero loss Eco-Drain is standard to automatically remove the captured moisture.



## Eco-friendly fluid filter

Our eco-friendly fluid filters feature metal-free filter elements in aluminum housings. At the end of their service life, the elements are safe for thermal disposal.

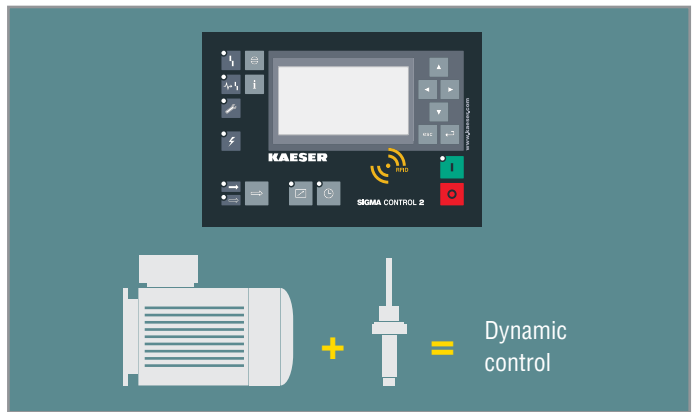

## Drive motor with Pt100 sensors

The dynamic control mode feature calculates load time based on the motor winding temperatures, reducing both idling time and energy consumption. For extra flexibility, Sigma Control 2 offers additional control modes that can be called up at any time.

# Service-friendly

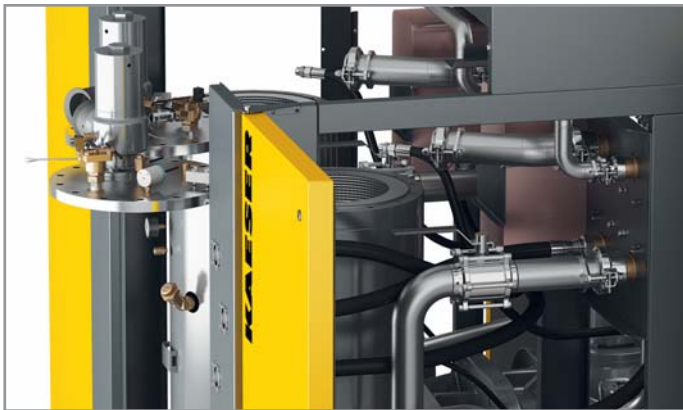
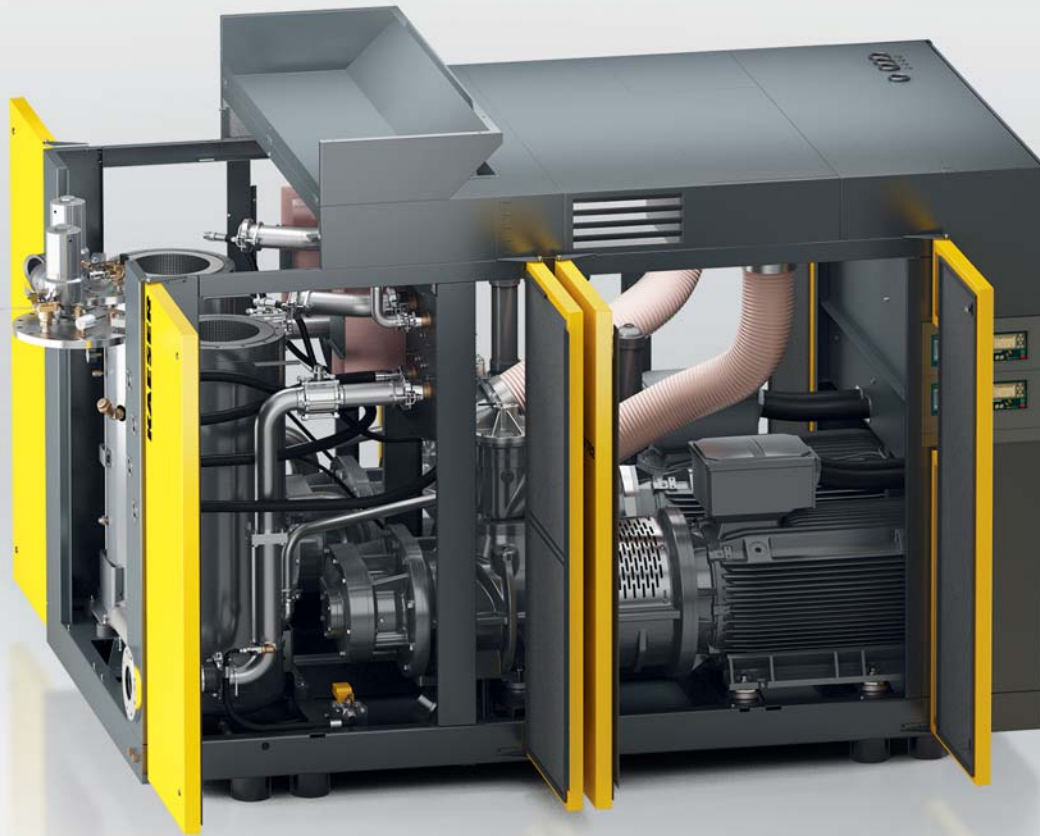

## Fluid separation system

Our 3-stage separation system ensures very low fluid carry-over (1-3 ppm), and extended filter service life. Our no-leak design features rigid steel piping, flexible connections, and vibration isolators. Each pressure vessel is ASME coded (CRN in Canada) and includes wet side/dry side fittings to check differential pressure, an easy to read fluid level indicator, and our unique quick fluid drain system.



## External grease fitting lubrication

The fan and drive motors have external grease fittings for safe and easy lubrication while the compressor is running.

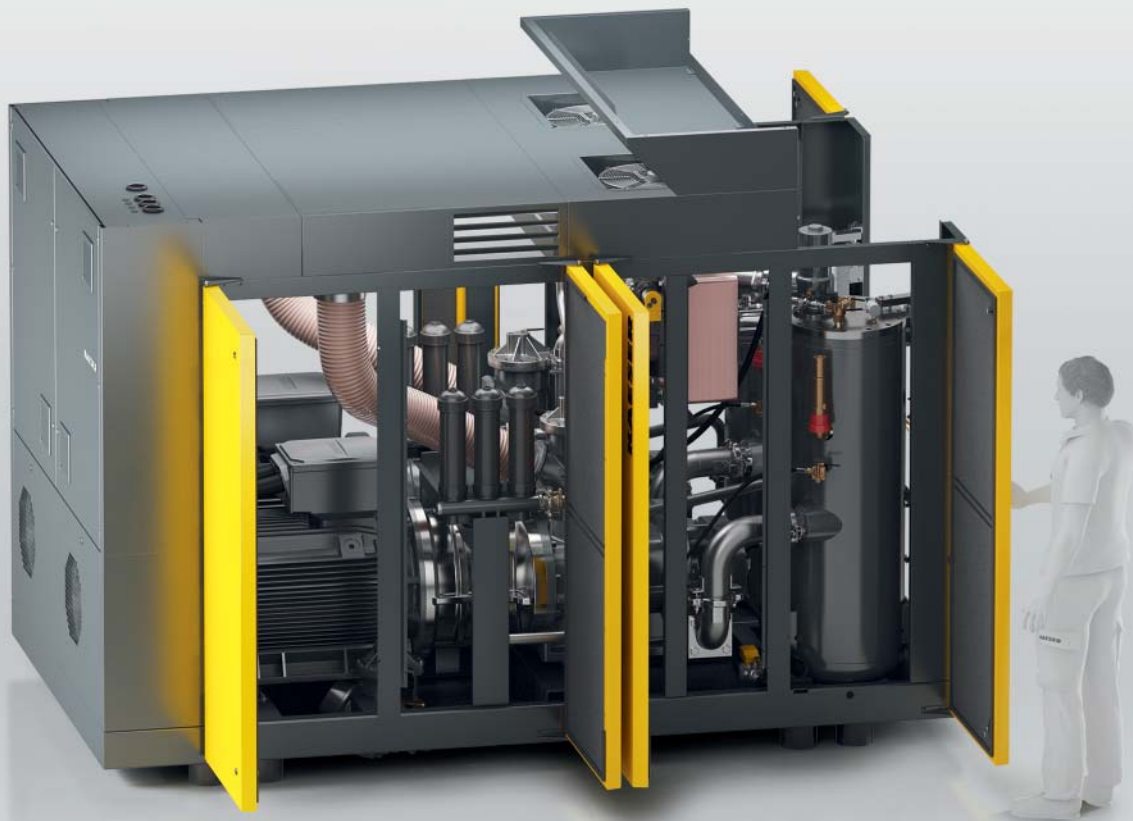

### Monitored air inlet filter

Sigma Control 2 continuously monitors the air inlet filter contamination level. This makes it easy to plan accordingly for the replacement date—based on either operational reliability or maximized economy.



### Easy servicing

HSD series rotary screw compressors feature an open package layout as well as a pivoting lid on the separator tank for ease of maintenance. All of the major components are easily accessible, reducing preventive maintenance time by as much as 50% when compared to other similarly sized units.

# Water-cooling

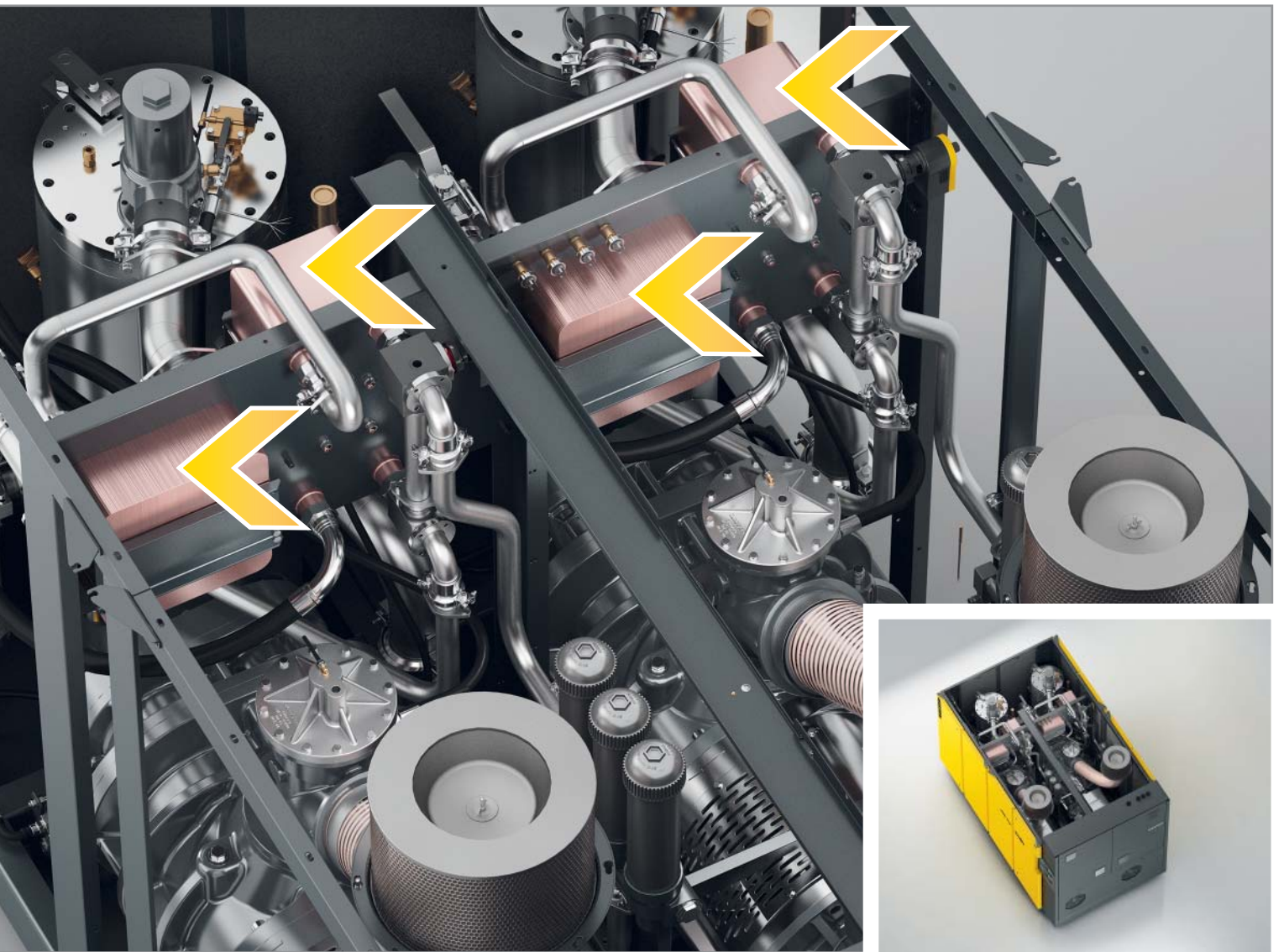

## Plate-type heat exchangers (standard)

Stainless steel plate type heat exchangers brazed with copper ensure excellent heat transfer and are corrosion and contamination-resistant.

Plate-type heat exchangers are the perfect choice for applications with a supply of clean cooling water.

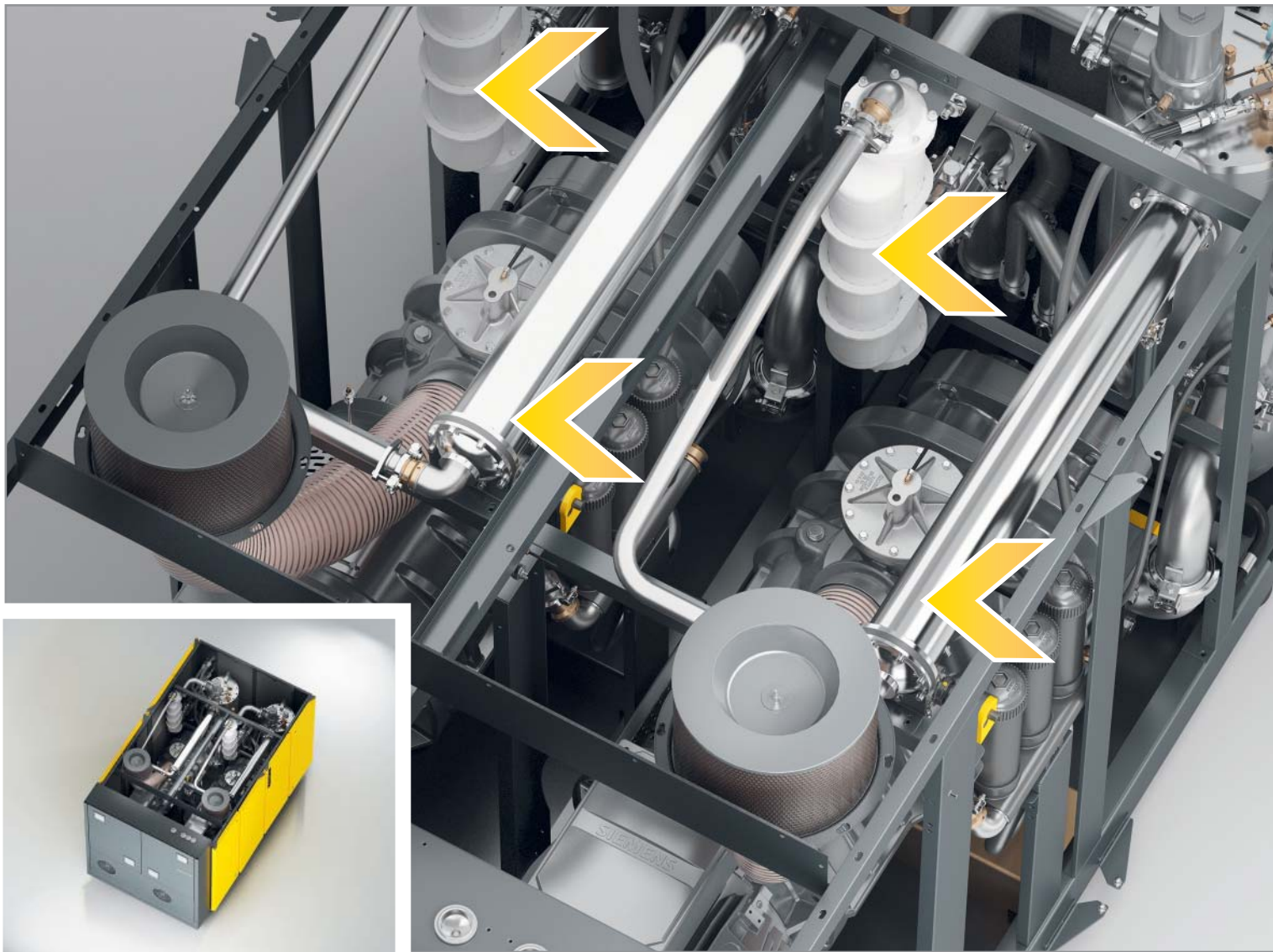

### Shell and tube heat exchangers (optional)

Shell and tube heat exchangers with copper nickel (CuNi10Fe) tubes are less susceptible to contamination than plate type heat exchangers and are mechanically cleanable. Additionally, the cooler inserts can be easily exchanged.

Shell and tube heat exchangers are sea water resistant, making them appropriate for marine applications. They also have very low pressure drop.

# Innovative package design

## Split cooling zones

The Kaeser package design separates inlet air flow from cooling air flows for more efficient compression. Further, drawing ambient air directly across the coolers and motor through separate zones eliminates preheating and results in longer lubricant life and a cooler running motor. This also results in much lower approach temperatures, improving moisture separation and air quality.

## Extremely low sound and vibration

All models come standard with Kaeser's superior cabinet that features complete metal enclosures with sound proofing liners and heavy-duty vibration isolation. Using one-to-one direct drive and our unique cooling airflow design with radial fans greatly reduces internal noise and vibration.

As a result, our compressors are about 10 dB(A) quieter than conventional compressors of equal performance with sound levels as low as 73 dB(A).

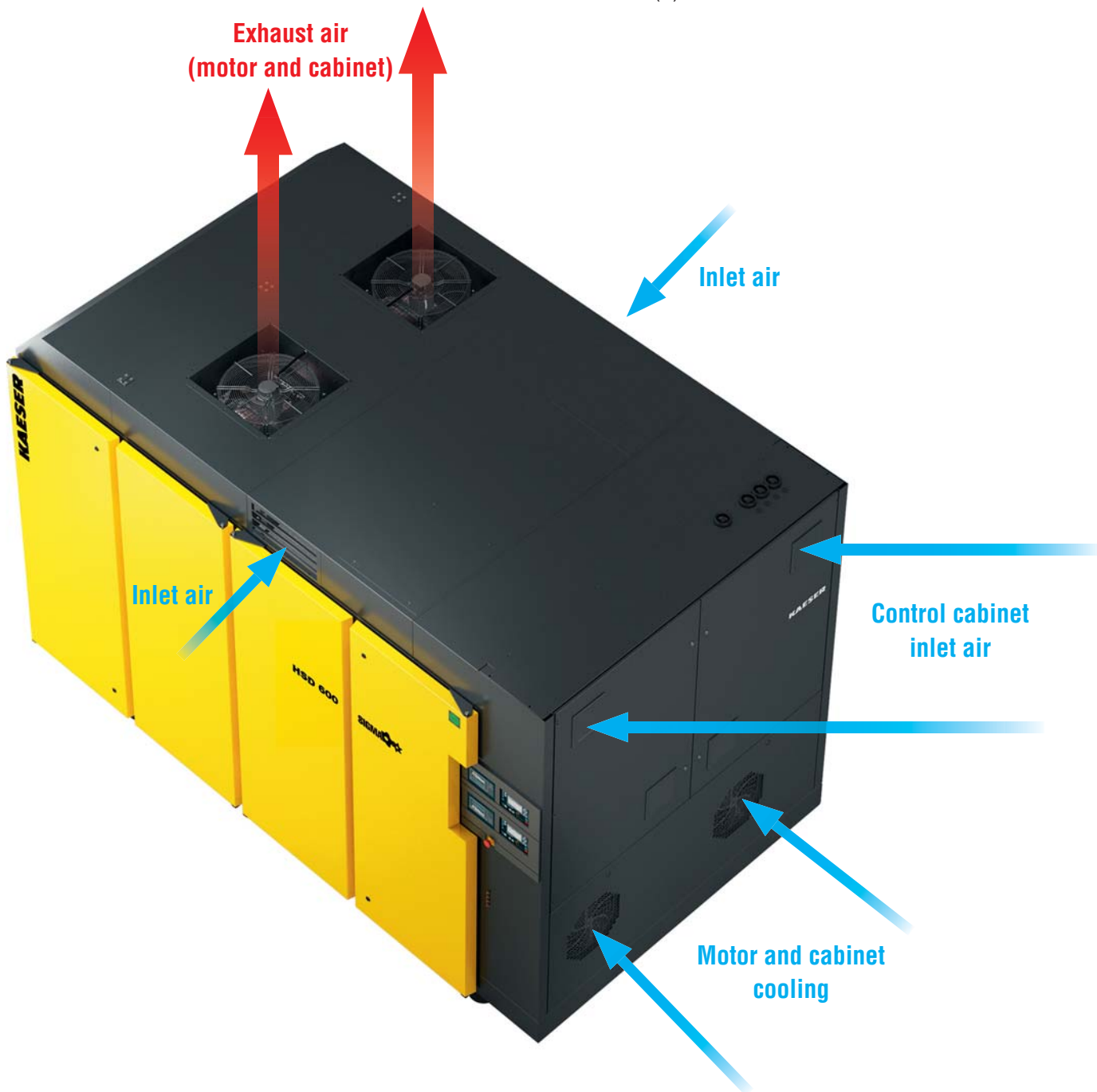

# Benefits at a glance



## Exceptional efficiency

Kaeser's Sigma Profile airend, high efficiency motors, and direct drive make an extremely efficient system. Combined with the precise control from our Sigma Control 2 and the system benefits of load splitting in part-load conditions, you can't beat the HSD for energy efficiency.

## Lower maintenance cost

Kaeser designed the HSD with the same maintenance friendly features as smaller machines:

- Easy access to service items and components

- Sigma Control 2 provides service reminders and diagnostic information
- External motor grease fittings
- Pressurized fluid change system
- Swiveling separator cover for easier cartridge changes
- Longer service intervals

## Lower installation costs

Packaging two compressors into one greatly reduces installation costs. Only one unit to ship and maneuver into place. Only one piping connection. Only one wiring connection.

## Small footprint

The HSD's small footprint frees up precious floor space and allows better access for service.

## High quality air

The following HSD features minimize oil and moisture in your air:

- Very fine internal filtration
- 3-stage fluid separation
- Super-efficient coolers
- Centrifugal moisture separators
- Automatic condensate drains

# Heat recovery



Up to  
**96%**  
usable for heat

A yellow bar chart icon with four vertical bars of varying heights, representing data or energy levels.

100% of the electrical drive energy input to a compressor is converted into heat energy. From that, up to 96% is available for lowering the cost of other processes in your plant that need heated water or other fluids.

Up to  
**+160 °F**

A red thermometer icon with a white scale and a red bulb, indicating temperature measurement.

Plate type heat exchanger systems can recover compressor heat to produce hot water or other fluids up to 160 °F. For higher temperature requirements, consult factory.



**Heating Plastic Molds**

**Metal Plating**

**Industrial Laundry**

**Food Processing**

**Pre-heat Steam**

**Wash Down**



The integrated system comprised of the heat exchanger, thermostatic valve, and complete pipework requires no additional space around the compressor and can recover up to 72% of the overall power consumption of HSD compressors by utilizing the heat in the oil.



Special fail-safe heat exchangers can be used to warm water that meets the highest standards for purity, such as for the food industry.

# Sigma Air Manager 4.0 and Kaeser Sigma Network

## Secure connectivity at the speed of your business

Sigma Air Manager (SAM) 4.0 is a master control system for all compressed air production and treatment components. The unique 3D*advanced* Control continuously analyzes various parameters (e.g. switching and control efficiency) and calculates the ideal combination of compressors to achieve optimum efficiency.

Based on secure Ethernet technology, the Kaeser Sigma Network is a local network that connects all components within the compressed air system. Together, SAM 4.0 and the Sigma Network create the perfect infrastructure for predictive maintenance and integration into the IIoT.

SAM 4.0 features Kaeser Connect which displays your compressed air system information in real-time on your desktop or laptop computer via a standard internet browser. Simple HTML pages show the compressors' operational state, SAM's operating and system pressure data, as well as service and alarm messages.

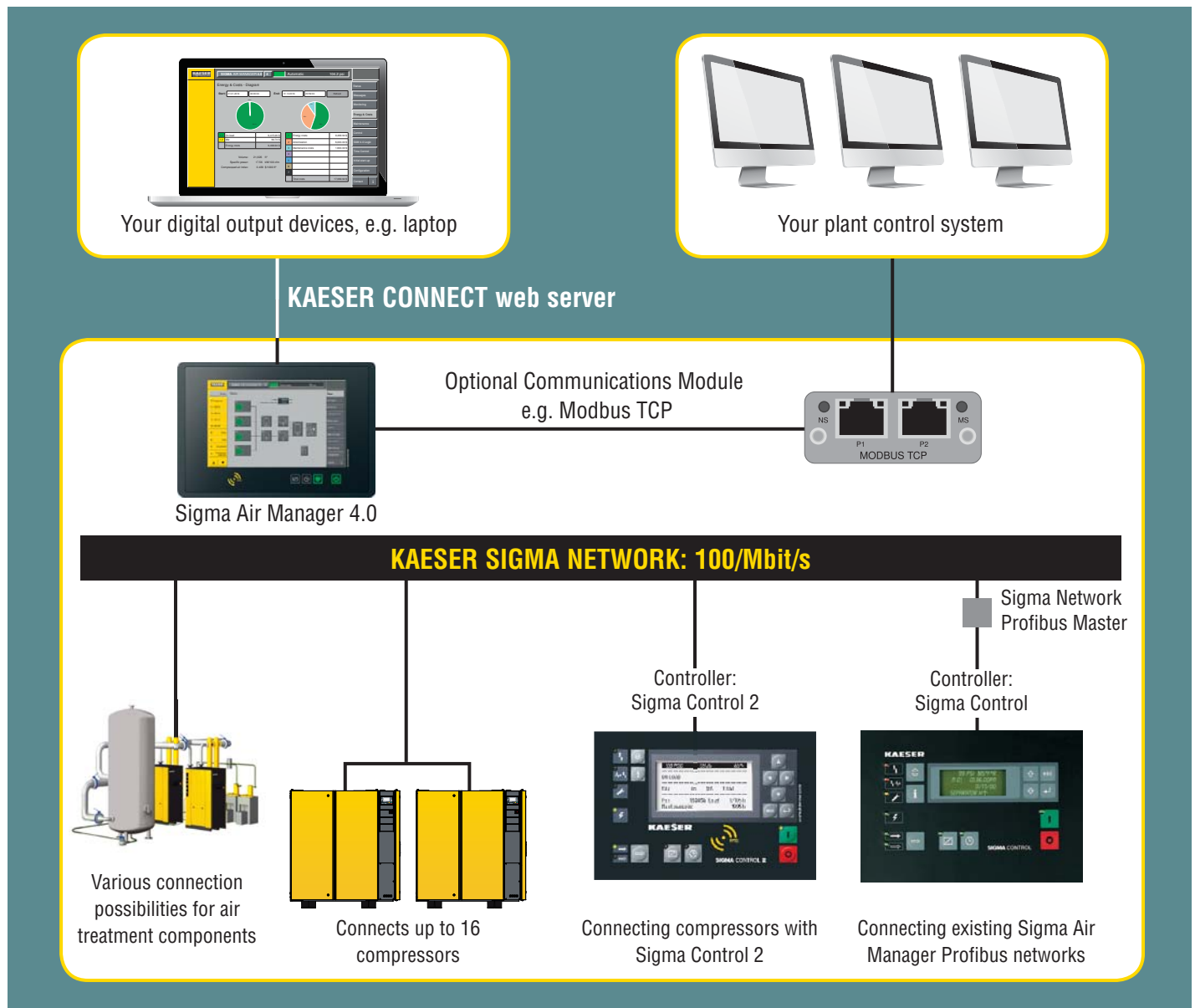
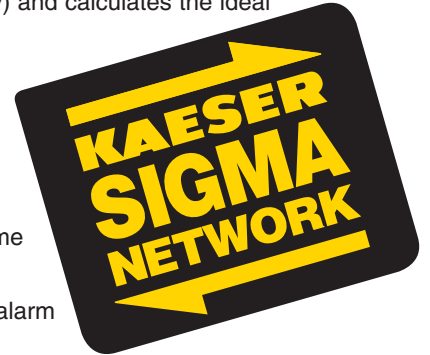

# Technical Specifications

Model	Pressure Range (psig)	Capacity (cfm) (1)	Rated Motor Power (hp)	Dimensions W x D x H (in.)	Weight (lb.) (2)	Sound Level dB(A) (3)
HSD 500	125	2311	500	140½ x 84½ x 92½	17,857	73
	175	1885				
HSD 550	125	2520	550			
	175	2062				
	217	1653				
HSD 600	125	2760	600			
	175	2266				
	217	1830				
HSD 650	125	3000	650			
	175	2471				
	217	2007				

(1) Performance rated in accordance with CAGI/ISO 1217 test code. (2) Weights may vary slightly depending on airend model. (3) Per ISO 2151 using ISO 9614-2.

**NOTE:** Other pressures available from 80 to 217 psig.

For units with variable frequency drive (SFC), please contact your local authorized Kaeser distributor.

*Specifications are subject to change without notice.*

## Much More Than Just Equipment Custom Designed Solutions

Our factory-trained representatives work closely with our application engineers to design a complete, custom system tailored to your requirements.

Using our Air Demand Analysis (ADA) and Kaeser Energy Saving System (KESS) we can evaluate your existing installation and demonstrate how proposed changes will improve your system performance.

Kaeser can also produce two-dimensional and three-dimensional drawings of the proposed system. This is a huge benefit in project planning. It helps visualize new equipment and how it will fit into the building along with existing equipment, piping, walls, vents, etc. This facilitates installation planning.

From complex installations, to challenging environments, to limited space, Kaeser can design a system to meet your specific requirements for performance and reliability.

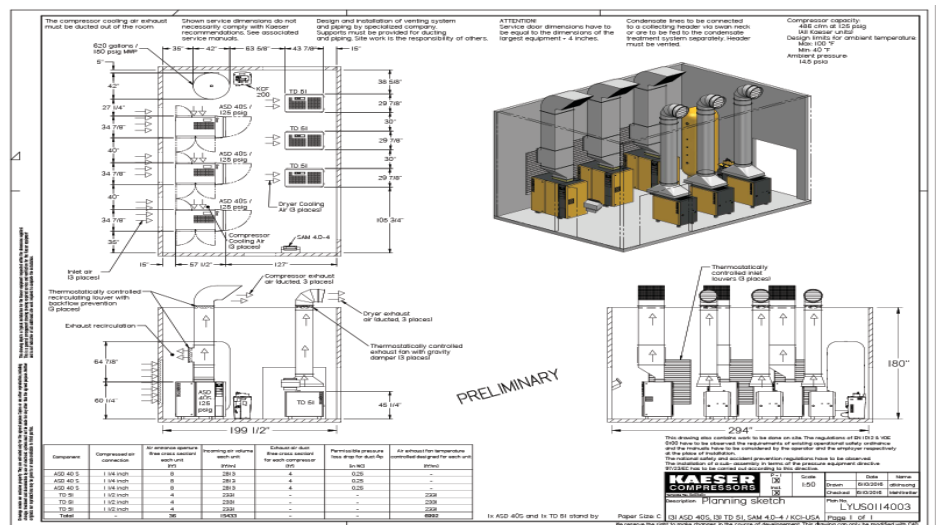

Accurate system drawings and schematics ensure proper pipe sizing and storage as well as adequate ventilation and space planning.

# The world is our home

As one of the world's largest compressed air systems providers and compressor manufacturers, Kaeser Compressors is represented throughout the world by a comprehensive network of branches, subsidiary companies and factory trained partners.

With innovative products and services, Kaeser Compressors' experienced consultants and engineers help customers to enhance their competitive edge by working in close partnership to develop progressive system concepts that continuously push the boundaries of performance and compressed air efficiency. Every Kaeser customer benefits from the decades of knowledge and experience gained from hundreds of thousands of installations worldwide and over ten thousand formal compressed air system audits.

These advantages, coupled with Kaeser's worldwide service organization, ensure that our compressed air products and systems deliver superior performance with maximum uptime.



**KAESER  
COMPRESSORS**

*Built for a lifetime.™*

[www.kaeser.com](http://www.kaeser.com)

**Kaeser Compressors, Inc.**  
511 Sigma Drive  
Fredericksburg, VA 22408 USA  
Telephone: 540-898-5500  
Toll Free: 800-777-7873  
[info.usa@kaeser.com](mailto:info.usa@kaeser.com)

**Kaeser Compressors Canada Inc.**  
3760 La Vérendrye Street  
Boisbriand, QC J7H 1R5 CANADA  
Telephone: (450) 971-1414  
Toll free: (800) 477-1416  
[info.canada@kaeser.com](mailto:info.canada@kaeser.com)

**Kaeser Compresores de México  
S de RL de CV**  
Calle 2 #123  
Parque Industrial Jurídica  
76100 Querétaro, Qro.  
Telephone: 01 (442) 218 64 48  
[sales.mexico@kaeser.com](mailto:sales.mexico@kaeser.com)

**Kaeser Compresores de  
Guatemala y Cia. Ltda.**  
Calz. Atanasio Tzul 21-00, zona 12  
El Cortijo II, Bodega 501  
01012-Guatemala City  
Telephone: +502 2412-6000  
[info.guatemala@kaeser.com](mailto:info.guatemala@kaeser.com)