



GEARWRENCH®

GET IT DONE.™



PRODUCT CATALOG

MASTER SETS | TOOL STORAGE | RATCHETS, SOCKETS & DRIVE TOOLS | IMPACT SOCKETS | WRENCHES | TORQUE WRENCHES | SCREWDRIVERS | PLIERS | CUTTING & FILING | STRIKING & STRUCK | PRY BARS | AUTOMOTIVE SPECIALTY | ALLEN HEX KEYS | JACOBS CHUCK | CRESCENT WRENCHES | LUFKIN TAPES | WISS SNIPS

YOU'VE COME TO THE RIGHT PLACE FOR INNOVATION

Ratcheting Flex Flare Nut Wrenches

- Quickly ratchet flare nuts and bolts without removing the wrench from the fastener
- Flex head provides access to difficult-to-reach hose fittings and gets around obstructions
- Ratcheting flex flare nut design exceeds ASME specifications



Ratcheting Crowfoot Wrenches

- Ratcheting open end allows you to advance the nut without removing the wrench from the fastener
- Use with 3/8" drive extensions to avoid obstructions
- Exceeds ASME requirements for torque performance



120XP™ Flex Head Ratchets

- Patent-pending Double-Stacked Pawl Technology™ provides 120 positions and a super-tight 3° ratchet arch
- 6-Position flex head for adjustable access angle
- Exceeds ASME torque performance requirements

120XP















Warranty – Standard Limited Lifetime

Apex warrants to each original Customer of Products sold by Apex that such Products (excluding carrying cases and storage accessories and the product categories set forth below) are, at the time of delivery to the Customer, free of material and workmanship defects, provided that no warranty is made with respect to: (a) any Product which has been modified, disassembled and/or reassembled or altered in any way or improperly installed; (b) any Product which has, in Apex's judgment, been subject to negligence, misuse, abuse, accident, improper storage or damage during shipment; (c) any Product which has not been operated and maintained in accordance with normal practice and in conformity with recommendations and published specifications of Apex; and (d) any Products which have been serviced or repaired by anyone other than an Authorized Repair Center of Apex or modified by anyone other than Apex. Normal wear and tear is also excluded.

Product Exceptions to the Standard Limited Lifetime Warranty:

- Tool Boxes, Standard Chucks and Accessories, Bits, Bit Sockets Torque Products.
- Soldering and De-Soldering Products are warranted only for one (1) year from date of Buyer acceptance.
- Accuracy standards for calibration on Torque Products are warranted for 90 days from date of buyer acceptance. Torque Products in North America must be sent to Angle Repair & Calibration Service, Inc., 175 Angle Drive, Beckley, West Virginia 25801 (304) 253-5729 at Customer's cost for evaluation. Product meeting warranty criteria will be repaired or replaced subject to Apex's sole discretion. Torque Product components are subject to normal wear through use and replacement thereof is the responsibility of the Customer. These warranties set forth herein are the sole warranties applicable to Products and is in lieu of all other warranties, whether express, implied or statutory. The implied warranties of merchantability and fitness for a particular purpose are specifically excluded.

Remedies: Customer's sole and exclusive remedy for breach of this Warranty is, at the option of Apex, repair or replacement of the defective product.

	Master Sets	7	1
	Tool Storage	25	2
	Ratchets, Sockets, and Drive Tools	35	3
	Impact Sockets	189	4
	Wrenches	229	5
	Torque Wrenches	313	6
	Screwdrivers and Nutdrivers	319	7
	Pliers	341	8
	Cutting and Filing	363	9
	Striking and Struck	373	10
	Pry Bars	381	11
	Automotive Specialty	385	12
	Allen® Hex Keys	483	13
	Jacobs® Chuck	491	14
	Trade Tools: Crescent® Wrenches & Pliers, Lufkin® Tapes, Wiss® Snips	495	15
	Alpha and Part Number Index	503	16



GEARWRENCH®

GearWrench started in 1996, when we developed a ratcheting wrench that stood up to professional environments – the “Original” combination ratcheting wrench.

Noticing the need for more ratcheting options, we quickly expanded to stubby and double box as these were traditional non-ratcheting wrench configurations.

The Reversible and Flex style wrenches were born from user feedback, with an eye for how to work in tight spaces.

THE “ORIGINAL”



COMBINATION RATCHETING WRENCH

STUBBY RATCHETING WRENCH

DOUBLE BOX RATCHETING WRENCH

REVERSIBLE RATCHETING WRENCH

FLEXIBLE RATCHETING WRENCH

STUBBY FLEX RATCHETING WRENCH

From the original ratcheting wrench to our newest 120XP Ratchets, GearWrench products strive to deliver innovation through our 3 core values:

1995

2000

GEARRATCHET VORTEX SOCKET SYSTEM



GEARDRIVER INTERCHANGABLE SHAFT SYSTEM



THE EVOLUTION OF INNOVATION

As more professionals began to use ratcheting wrenches, we spent time solving more access problems and introducing other wrench styles.

Having success in wrenches, we began to integrate ratcheting mechanisms into screwdrivers and other traditionally non-ratcheting tools.

GearWrench has continued to innovate products by adding productivity features to products like pry bars, hemostats, tool boxes, and ratchets.

**SPEED
STRENGTH
ACCESS**

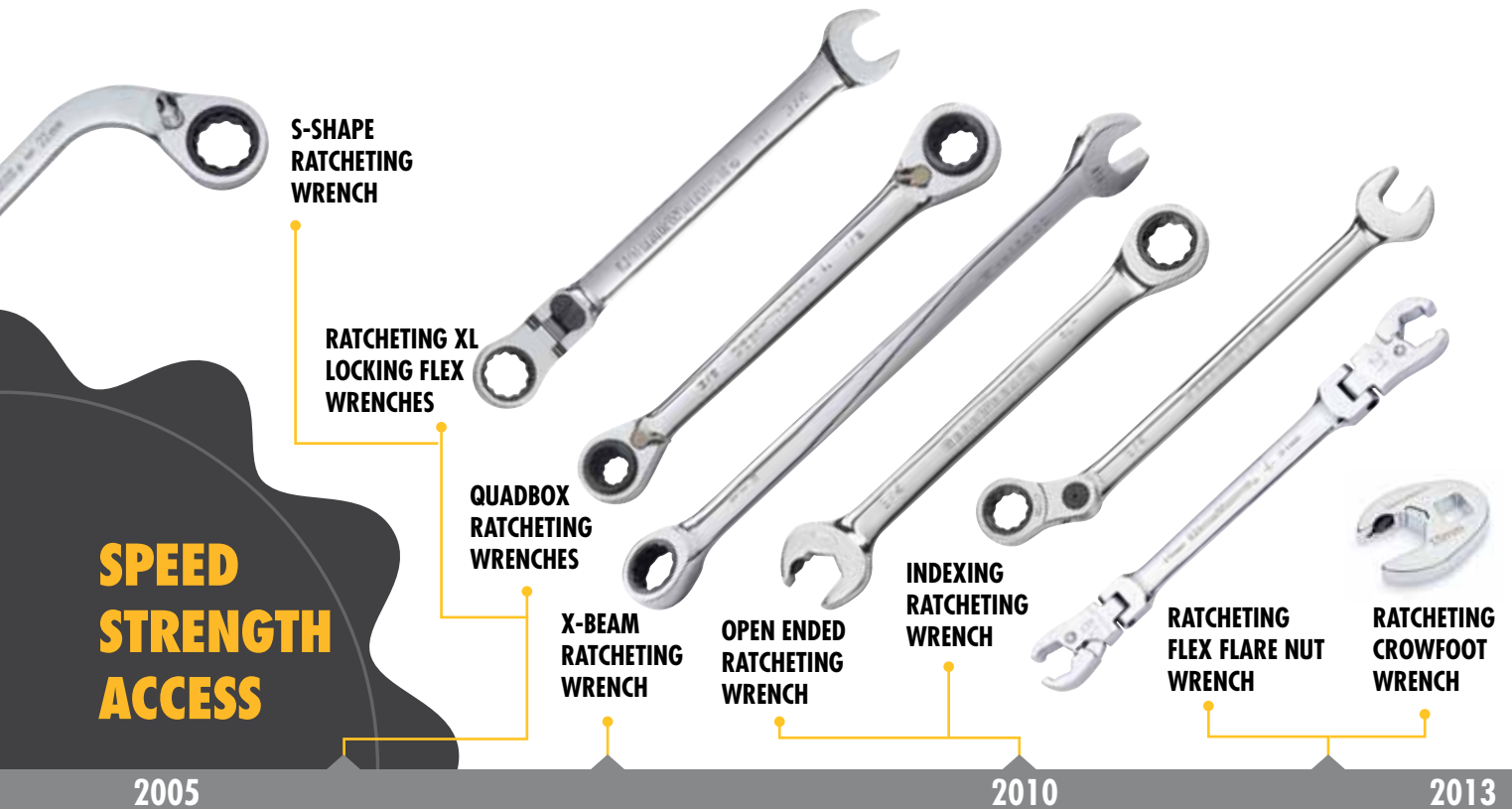

THE 120XP

How GearWrench helps you

GET IT DONE



Since its revolutionary inception in the mid 1990's, GearWrench has proven itself to be a force to be reckoned with in the tool industry. The original GearWrench® ratcheting wrench is now a tool box necessity for almost every professional tool user. Scores of innovative new products, designed to provide a solution for nearly any task, are being introduced every year. We make it our business to know the challenges you face on the job so we can create the tools that help you get the job done faster.

GearWrench has always focused on continuous improvement in three areas: speed, strength, and access. Using the latest Voice-of-Customer techniques and our proprietary Inventor Connect program, we listen to pro tool users to learn how we can design tools that better answer their needs. As a result, the majority of new GearWrench products begin development because of direct customer feedback. So keep talking to us, and we'll keep listening and designing better products to help make your job go faster and easier. Together we can **Get It Done.**



Have an Idea?

**Inventor
Connect**

Tell us about it at

www.newtoolinventor.com

RATCHETS

SOCKETS

WRENCHES

SPEED

GearWrench understands the need for speed. It's not about showing off; it's about getting more done. It's about shaving valuable seconds off tasks that get repeated hundreds of times each day. For the pro, those seconds add up.



120XP ratchets provide a super-tight 3° ratcheting arc, so you can turn fasteners in more confined spaces.



GearWrench sockets are designed to quickly nest onto fasteners and have clear size markings for instant identification.



The many styles of GearWrench ratcheting wrenches provide the speed of a ratchet with the access of a wrench.

STRENGTH

Professional hand tools need to be strong in order to provide years of reliable service. GearWrench tools are tough and reliable, meeting or exceeding recognized industry standards. GearWrench tools Get It Done for a very long time.

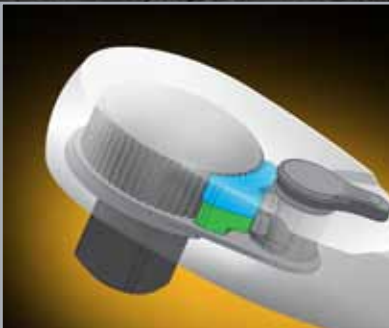

Patent Pending GearWrench Double-Stacked Pawl™ technology delivers 180% of ASME torque performance.*

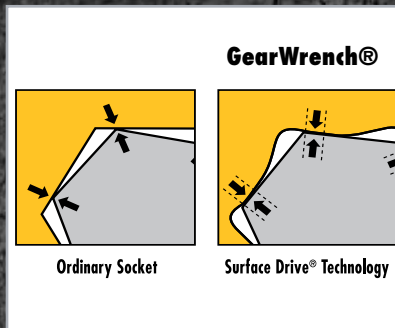

Surface Drive design puts force on the flats of fasteners for improved durability and reduced fastener rounding.



All GearWrench wrenches exceed ANSI specifications and are designed to provide reliable performance and long life.

ACCESS

Every job is different, but you can almost always count on obstructions and tight spaces. GearWrench offers a wide selection of wrenches and other tools designed to get the job done, even in cramped, hard-to-reach areas.



Low profile head with flush-mounted on / off switch allows better access in tight spaces.



Our line of deep, mid-length, and standard sockets provides perfect access for any job.

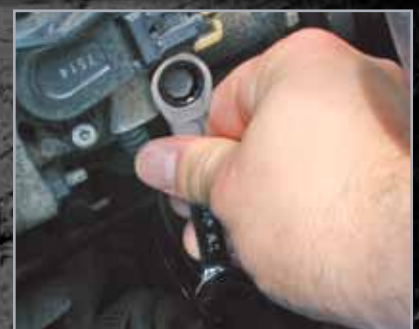

GearWrench has wrench styles to fit every application, including flex-head, S-shape, and stubby.

TECHNICAL EDUCATION SOLUTIONS

Starting a new career can be one of the most nerve-racking experiences in a person's life. For a technician, starting out can be especially tough when making that initial investment in the tools necessary to make a living in the future.

GearWrench and our Technical Educational Program (TEP) can help ease that anxiety. We work with the leading instructors, institutions, and OEM manufacturers to ensure that when a student purchases a GearWrench TEP kit from an authorized distributor, they have the right tools for the job from day one, all without putting the student into severe debt. The bottom line is GearWrench provides students with fully featured products at a significant value.

- **AUTO BODY**
- **HVAC**
- **ELECTRICAL**
- **DIESEL**
- **HYBRIDS**
- **WIND ENERGY**

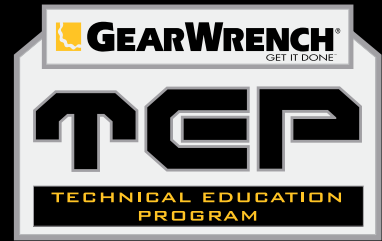

- Fully Featured Innovative Products
- Discounted Tool Sets and Tool Storage
- Free Tools for Students and Schools
- Free Hats, T-Shirts, Posters, etc.

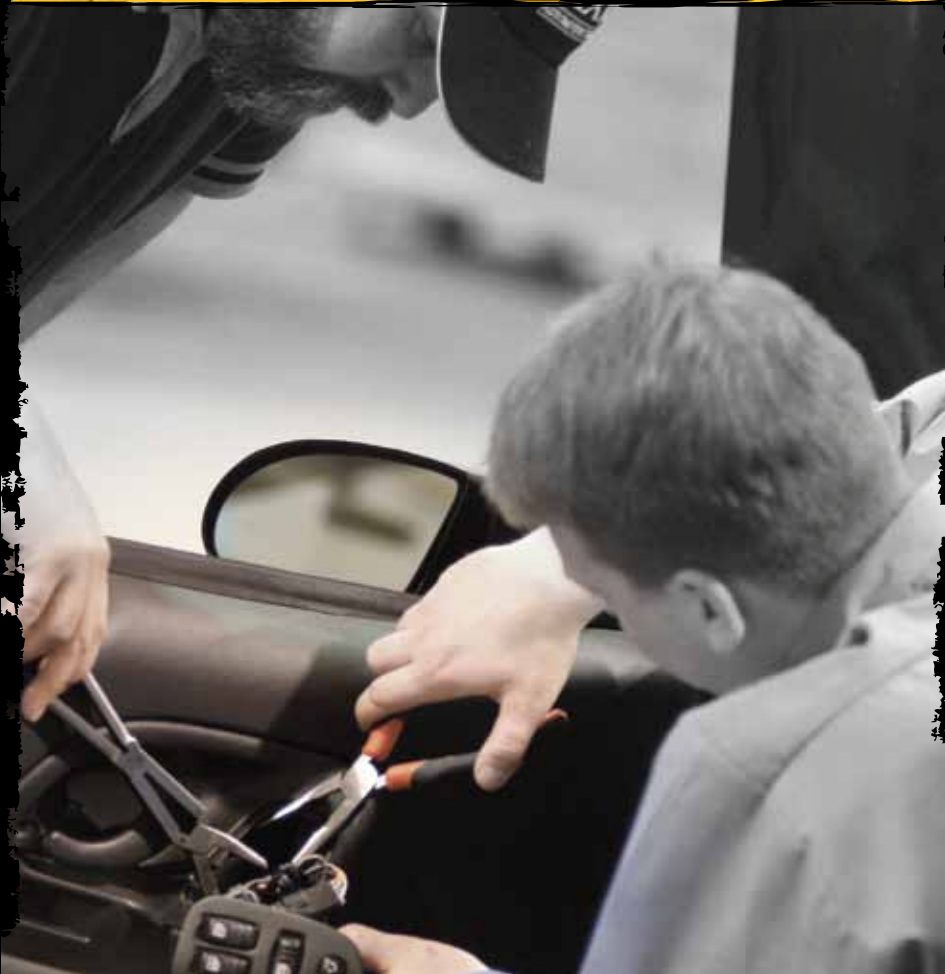



Auto Introductory Set	9
Career Builder Starter Set	10
Diesel Add-On	12
Auto Body Add-On	13
Career Builder HVAC Add-On.....	14
Intermediate Auto Set.....	15
Intermediate Auto Body Set	17
Intermediate Diesel Set	19
Aviation Introductory Set	21
Intermediate Aviation Set.....	22



GEARWRENCH® Master Sets

The GearWrench Technical Education Program features carefully designed sets to fully equip the Student Technician with the tools necessary to conquer the service and repair challenges in today's Automotive, Heavy Duty/Diesel, Machinery, and Aviation fields.



Each tool set features innovations in speed, access, and design, hallmarks that have established the GearWrench® brand as a leader in quality, professional hand tools.

Each Technical Education Set also includes storage for sockets, wrenches, screwdrivers, and other tools to help promote efficient tool organization.



GEARWRENCH® Auto Introductory TEP Set

- 84-Tooth 1/4" and 3/8" Drive Ratchets
- Extensions – 1/4" and 3/8" Drive
- Universal Joint – 3/8" Drive
- Sockets – 1/4" and 3/8" Drive in SAE and Metric Sizes
- Wrenches – Long Pattern Combination in SAE and Metric Sizes
- Screwdrivers – 6 Pc. Set
- Pliers – 3 Pc. Set, Punches and Chisels – 5 Pc. set
- ALLEN® Hex Key Set – 13 Pc. SAE
- General Purpose Tools – Hammers, Utility Knife, Flashlight, Locking Pliers, Safety Glasses
- Automotive Specialty Tools – Low Voltage Circuit Tester, Feeler Gauge, Gasket Scraper



Cat. No.	UPC No.	Description
83090*	099575830907	Auto Introductory TEP Set

* Please Note: Most tools GearWrench branded. May include other leading Apex Tool Group brands.

Cat. No.	Description	Cat. No.	Description	Cat. No.	Description
129D	Low-Voltage Circuit Tester	81663	15/16" Long Pattern Combination Wrench	80132	1/4" Drive 6 Point Standard Metric Socket 10mm
162D	Feeler Gauge	81664	1" Long Pattern Combination Wrench	80133	1/4" Drive 6 Point Standard Metric Socket 11mm
80001	Dual Material Phillips® Screwdriver #1 x 3"	81665	8mm Long Pattern Combination Wrench	80134	1/4" Drive 6 Point Standard Metric Socket 12mm
80007	Dual Material Phillips® Screwdriver #2 x 4"	81666	9mm Long Pattern Combination Wrench	80135D	1/4" Drive 6 Point Standard Metric Socket 13mm
80013	Dual Material Slotted Screwdriver 1/4 x 4"	81667	10mm Long Pattern Combination Wrench	80136	1/4" Drive 6 Point Standard Metric Socket 14mm
80015	Dual Material Slotted Screwdriver 1/8 x 3"	81668	11mm Long Pattern Combination Wrench	80137	1/4" Drive 6 Point Standard Metric Socket 15mm
80022	Dual Material Slotted Screwdriver 3/8 x 8"	81669	12mm Long Pattern Combination Wrench	80350	3/8" Drive 6 Point Standard SAE Socket 1/4"
80023	Dual Material Slotted Screwdriver 5/16 x 6"	81670	13mm Long Pattern Combination Wrench	80351	3/8" Drive 6 Point Standard SAE Socket 5/16"
82011	9-1/2" Tongue and Groove Pliers	81671	14mm Long Pattern Combination Wrench	80352	3/8" Drive 6 Point Standard SAE Socket 3/8"
82012	7" Diagonal Cutting Pliers	81672	15mm Long Pattern Combination Wrench	80353	3/8" Drive 6 Point Standard SAE Socket 7/16"
82013	8" Long Nose Pliers	81673	16mm Long Pattern Combination Wrench	80354	3/8" Drive 6 Point Standard SAE Socket 1/2"
82251	16 oz Ball Pein Hammer - Fiberglass	81674	17mm Long Pattern Combination Wrench	80355	3/8" Drive 6 Point Standard SAE Socket 9/16"
82260	12 oz Soft Face Hammer, Removable Caps	81675	18mm Long Pattern Combination Wrench	80356	3/8" Drive 6 Point Standard SAE Socket 5/8"
82264	1/2" x 6" x 3/8" Cold Chisel	81676	19mm Long Pattern Combination Wrench	80357	3/8" Drive 6 Point Standard SAE Socket 11/16"
82270	3/8" x 5" Center Punch	81677	20mm Long Pattern Combination Wrench	80358	3/8" Drive 6 Point Standard SAE Socket 3/4"
82273	1/8" x 5" x 5/16" Pin Punch	81678	21mm Long Pattern Combination Wrench	80359	3/8" Drive 6 Point Standard SAE Socket 13/16"
82274	5/32" x 5-1/4" x 5/16" Pin Punch	81679	22mm Long Pattern Combination Wrench	80360	3/8" Drive 6 Point Standard SAE Socket 7/8"
82275	3/16" x 5-1/2" x 5/16" Pin Punch	81011F	1/4" Drive Full Polish Teardrop Ratchet	80361	3/8" Drive 6 Point Standard SAE Socket 15/16"
82881	Folding Utility Knife	81211F	3/8" Drive Full Polish Teardrop Ratchet	80362	3/8" Drive 6 Point Standard SAE Socket 1"
83132	LED Flashlight with Carry Case	80105	1/4" Drive 6 Point Standard SAE Socket 3/16"	80374	3/8" Drive 6 Point Standard Metric Socket 6mm
84083	1" Wide Scraper Long	80106	1/4" Drive 6 Point Standard SAE Socket 7/32"	80375	3/8" Drive 6 Point Standard Metric Socket 7mm
C10CV	10" Curved Jaw Locking Plier With Wire Cutter	80107	1/4" Drive 6 Point Standard SAE Socket 1/4"	80376	3/8" Drive 6 Point Standard Metric Socket 8mm
-	Safety Glasses	80108	1/4" Drive 6 Point Standard SAE Socket 9/32"	80377	3/8" Drive 6 Point Standard Metric Socket 9mm
56603G	13 Piece Long Arm SAE Hex Key Set	80109	1/4" Drive 6 Point Standard SAE Socket 5/16"	80378	3/8" Drive 6 Point Standard Metric Socket 10mm
81128	1/4" Socket Driver	80110	1/4" Drive 6 Point Standard SAE Socket 11/32"	80379	3/8" Drive 6 Point Standard Metric Socket 11mm
81113D	1/4" Drive Standard Extension 3"	80111	1/4" Drive 6 Point Standard SAE Socket 3/8"	80380	3/8" Drive 6 Point Standard Metric Socket 12mm
81116	1/4" Drive Standard Extension 6"	80112	1/4" Drive 6 Point Standard SAE Socket 7/16"	80381	3/8" Drive 6 Point Standard Metric Socket 13mm
81241	3/8" Drive Standard Extension 3"	80113D	1/4" Drive 6 Point Standard SAE Socket 1/2"	80382	3/8" Drive 6 Point Standard Metric Socket 14mm
81242	3/8" Drive Standard Extension 6"	80114D	1/4" Drive 6 Point Standard SAE Socket 9/16"	80383	3/8" Drive 6 Point Standard Metric Socket 15mm
81656	1/2" Long Pattern Combination Wrench	80125	1/4" Drive 6 Point Standard Metric Socket 4mm	80384	3/8" Drive 6 Point Standard Metric Socket 16mm
81657	9/16" Long Pattern Combination Wrench	80126	1/4" Drive 6 Point Standard Metric Socket 5mm	80385	3/8" Drive 6 Point Standard Metric Socket 17mm
81658	5/8" Long Pattern Combination Wrench	80127	1/4" Drive 6 Point Standard Metric Socket 5.5mm	80386	3/8" Drive 6 Point Standard Metric Socket 18mm
81659	11/16" Long Pattern Combination Wrench	80128	1/4" Drive 6 Point Standard Metric Socket 6mm	80387	3/8" Drive 6 Point Standard Metric Socket 19mm
81660	3/4" Long Pattern Combination Wrench	80129	1/4" Drive 6 Point Standard Metric Socket 7mm	80402	3/8" Drive Spark Plug Socket 5/8"
81661	13/16" Long Pattern Combination Wrench	80130	1/4" Drive 6 Point Standard Metric Socket 8mm	80403	3/8" Drive Spark Plug Socket 13/16"
81662	7/8" Long Pattern Combination Wrench	80131D	1/4" Drive 6 Point Standard Metric Socket 9mm	80549	3/8" Drive Universal Joint

1 MASTER SETS

GEARWRENCH® Career Builder Starter TEP Set

- 84-Tooth 1/4", 3/8" and 1/2" Drive Ratchets
- Extensions – 1/4", 3/8" and 1/2" Drive
- Universal Joint – 1/4", 3/8" and 1/2" Drive
- Sockets – 1/4" and 3/8" Drive in Standard and Deep, SAE and Metric, 1/2" Drive in Standard Length SAE and Metric
- Wrenches – Long Pattern Combination in SAE and Metric Sizes
- Screwdrivers – 12 Pc. Set, Files – 4 Pc. Set
- Pliers – 4 Pc. Set, Punches and Chisels – 12 Pc. set
- ALLEN® Hex Key Set – 13 Pc. SAE, 9 Pc. Metric
- General Purpose Tools – Pry Bar, Hammers, Utility Knife, Flashlight, Locking Pliers, Safety Glasses, Tape Measure
- Automotive Specialty Tools – Low Voltage Circuit Tester, Feeler Gauge, Gasket Scraper, and More



Cat. No.	UPC No.	Description
83091*	099575830914	Career Builder Starter TEP Set

* Please Note: Most tools GearWrench branded. May include other leading Apex Tool Group brands.

Cat. No.	Description	Cat. No.	Description	Cat. No.	Description
129D	Low-Voltage Circuit Tester	82285	1/8" x 4-1/2" x 5/16" Starter	80023	Dual Material Slotted Screwdriver 5/16 x 6"
162D	Feeler Gauge	82822D	8" Flat Bastard File	56612G	13 Piece Long Arm SAE Ball-Plus™ Hex Key Set
2109D	2-1/4" Round Telescoping Mirror	82823	8" Round Bastard File	56615G	9 Piece Long Arm Metric Ball-Plus™ Hex Key Set
80965	12" Cushion Grip High Tension Hacksaw Frame	82824	8" Half Round Bastard File	81128	1/4" Socket Driver
82011	9-1/2" Tongue and Groove Pliers	82825	8" Triangle Bastard File	81113D	1/4" Drive Standard Extension 3"
82012	7" Diagonal Cutting Pliers	82881	Folding Utility Knife	81116	1/4" Drive Standard Extension 6"
82013	8" Long Nose Pliers	83132	LED Flashlight with Carry Case	81241	3/8" Drive Standard Extension 3"
82014	8" Slip Joint Pliers	84083	1" Wide Scraper Long	81242	3/8" Drive Standard Extension 6"
82216	16" Indexing Pry Bar	C10CV	10" Curved Jaw Locking Plier With Wire Cutter	81341	1/2" Drive Standard Extension 5"
82251	16 oz Ball Pein Hammer - Fiberglass	C6NV	6" Long Nose Locking Plier With Wire Cutter	81342	1/2" Drive Standard Extension 10"
82255	3 lb Drilling Hammer	-	Safety Glasses	81650	1/4" Long Pattern Combination Wrench
82259	16 oz Rubber Mallet - Wood Hickory Handle	PS3316	3/4" x 16" Pro Series 3000 Power Return Tape	81651D	9/32" Long Pattern Combination Wrench
82260	12 oz Soft Face Hammer, Removable Caps	80000	Dual Material Phillips® Screwdriver #0 x 2-1/2"	81652D	5/16" Long Pattern Combination Wrench
82261	1/4" x 4-3/4" x 1/4" Cold Chisel	80001	Dual Material Phillips® Screwdriver #1 x 3"	81653	11/32" Long Pattern Combination Wrench
82262	3/8" x 5" x 5/16" Cold Chisel	80004	Dual Material Phillips® Screwdriver #1 x 6"	81654	3/8" Long Pattern Combination Wrench
82264	1/2" x 6" x 3/8" Cold Chisel	80005	Dual Material Phillips® Screwdriver #2 x 1-1/2"	81655	7/16" Long Pattern Combination Wrench
82265	5/8" x 6-1/2" x 3/8" Cold Chisel	80007	Dual Material Phillips® Screwdriver #2 x 4"	81656	1/2" Long Pattern Combination Wrench
82270	3/8" x 5" Center Punch	80011	Dual Material Phillips® Screwdriver #3 x 6"	81657	9/16" Long Pattern Combination Wrench
82272	3/32" x 4-3/4" x 5/16" Pin Punch	2282D	Slotted Screw Starter	81658	5/8" Long Pattern Combination Wrench
82273	1/8" x 5" x 5/16" Pin Punch	80012D	Dual Material Slotted Screwdriver 1/4 x 1-1/2"	81659	11/16" Long Pattern Combination Wrench
82274	5/32" x 5-1/4" x 5/16" Pin Punch	80013	Dual Material Slotted Screwdriver 1/4 x 4"	81660	3/4" Long Pattern Combination Wrench
82275	3/16" x 5-1/2" x 5/16" Pin Punch	80014	Dual Material Slotted Screwdriver 1/4 x 6"	81661	13/16" Long Pattern Combination Wrench
82278	1/8" x 8" x 3/8" Long Taper Punch	80018D	Dual Material Slotted Screwdriver 3/16 x 6"	81662	7/8" Long Pattern Combination Wrench
82283	3/16" x 5" x 3/8" Starter Punch	80022	Dual Material Slotted Screwdriver 3/8 x 8"	81663	15/16" Long Pattern Combination Wrench

Cat. No.	Description	Cat. No.	Description	Cat. No.	Description
81664	1" Long Pattern Combination Wrench	80136	1/4" Drive 6 Point Standard Metric Socket 14mm	80385	3/8" Drive 6 Point Standard Metric Socket 17mm
81665	8mm Long Pattern Combination Wrench	80137	1/4" Drive 6 Point Standard Metric Socket 15mm	80386	3/8" Drive 6 Point Standard Metric Socket 18mm
81666	9mm Long Pattern Combination Wrench	80138	1/4" Drive 6 Point Deep Metric Socket 4mm	80387	3/8" Drive 6 Point Standard Metric Socket 19mm
81667	10mm Long Pattern Combination Wrench	80139	1/4" Drive 6 Point Deep Metric Socket 5mm	80388	3/8" Drive 6 Point Deep Metric Socket 6mm
81668	11mm Long Pattern Combination Wrench	80140	1/4" Drive 6 Point Deep Metric Socket 5.5mm	80389	3/8" Drive 6 Point Deep Metric Socket 7mm
81669	12mm Long Pattern Combination Wrench	80141	1/4" Drive 6 Point Deep Metric Socket 6mm	80390	3/8" Drive 6 Point Deep Metric Socket 8mm
81670	13mm Long Pattern Combination Wrench	80142	1/4" Drive 6 Point Deep Metric Socket 7mm	80391	3/8" Drive 6 Point Deep Metric Socket 9mm
81671	14mm Long Pattern Combination Wrench	80143	1/4" Drive 6 Point Deep Metric Socket 8mm	80392	3/8" Drive 6 Point Deep Metric Socket 10mm
81672	15mm Long Pattern Combination Wrench	80144	1/4" Drive 6 Point Deep Metric Socket 9mm	80393D	3/8" Drive 6 Point Deep Metric Socket 11mm
81673	16mm Long Pattern Combination Wrench	80145	1/4" Drive 6 Point Deep Metric Socket 10mm	80394D	3/8" Drive 6 Point Deep Metric Socket 12mm
81674	17mm Long Pattern Combination Wrench	80146D	1/4" Drive 6 Point Deep Metric Socket 11mm	80395	3/8" Drive 6 Point Deep Metric Socket 13mm
81675	18mm Long Pattern Combination Wrench	80147	1/4" Drive 6 Point Deep Metric Socket 12mm	80396	3/8" Drive 6 Point Deep Metric Socket 14mm
81676	19mm Long Pattern Combination Wrench	80148	1/4" Drive 6 Point Deep Metric Socket 13mm	80397	3/8" Drive 6 Point Deep Metric Socket 15mm
81677	20mm Long Pattern Combination Wrench	80149	1/4" Drive 6 Point Deep Metric Socket 14mm	80398	3/8" Drive 6 Point Deep Metric Socket 16mm
81678	21mm Long Pattern Combination Wrench	80150	1/4" Drive 6 Point Deep Metric Socket 15mm	80399	3/8" Drive 6 Point Deep Metric Socket 17mm
81679	22mm Long Pattern Combination Wrench	80350	3/8" Drive 6 Point Standard SAE Socket 1/4"	80400	3/8" Drive 6 Point Deep Metric Socket 18mm
81011F	1/4" Drive Full Polish Teardrop Ratchet	80351	3/8" Drive 6 Point Standard SAE Socket 5/16"	80401	3/8" Drive 6 Point Deep Metric Socket 19mm
81211F	3/8" Drive Full Polish Teardrop Ratchet	80352	3/8" Drive 6 Point Standard SAE Socket 3/8"	80603	1/2" Drive 6 Point Standard SAE Socket 1/2"
81304F	1/2" Drive Full Polish Teardrop Ratchet	80353	3/8" Drive 6 Point Standard SAE Socket 7/16"	80604	1/2" Drive 6 Point Standard SAE Socket 9/16"
80105	1/4" Drive 6 Point Standard SAE Socket 3/16"	80354	3/8" Drive 6 Point Standard SAE Socket 1/2"	80605	1/2" Drive 6 Point Standard SAE Socket 5/8"
80106	1/4" Drive 6 Point Standard SAE Socket 7/32"	80355	3/8" Drive 6 Point Standard SAE Socket 9/16"	80606	1/2" Drive 6 Point Standard SAE Socket 11/16"
80107	1/4" Drive 6 Point Standard SAE Socket 1/4"	80356	3/8" Drive 6 Point Standard SAE Socket 5/8"	80607D	1/2" Drive 6 Point Standard SAE Socket 3/4"
80108	1/4" Drive 6 Point Standard SAE Socket 9/32"	80357	3/8" Drive 6 Point Standard SAE Socket 11/16"	80608	1/2" Drive 6 Point Standard SAE Socket 13/16"
80109	1/4" Drive 6 Point Standard SAE Socket 5/16"	80358	3/8" Drive 6 Point Standard SAE Socket 3/4"	80609	1/2" Drive 6 Point Standard SAE Socket 7/8"
80110	1/4" Drive 6 Point Standard SAE Socket 11/32"	80359	3/8" Drive 6 Point Standard SAE Socket 13/16"	80610D	1/2" Drive 6 Point Standard SAE Socket 15/16"
80111	1/4" Drive 6 Point Standard SAE Socket 3/8"	80360	3/8" Drive 6 Point Standard SAE Socket 7/8"	80611	1/2" Drive 6 Point Standard SAE Socket 1"
80112	1/4" Drive 6 Point Standard SAE Socket 7/16"	80361	3/8" Drive 6 Point Standard SAE Socket 15/16"	80612	1/2" Drive 6 Point Standard SAE Socket 1-1/16"
80113D	1/4" Drive 6 Point Standard SAE Socket 1/2"	80362	3/8" Drive 6 Point Standard SAE Socket 1"	80613	1/2" Drive 6 Point Standard SAE Socket 1-1/8"
80114D	1/4" Drive 6 Point Standard SAE Socket 9/16"	80363	3/8" Drive 6 Point Deep SAE Socket 1/4"	80624	1/2" Drive 6 Point Standard Metric Socket 12mm
80115	1/4" Drive 6 Point Deep SAE Socket 3/16"	80364	3/8" Drive 6 Point Deep SAE Socket 5/16"	80625	1/2" Drive 6 Point Standard Metric Socket 13mm
80116D	1/4" Drive 6 Point Deep SAE Socket 7/32"	80365	3/8" Drive 6 Point Deep SAE Socket 3/8"	80626D	1/2" Drive 6 Point Standard Metric Socket 14mm
80117	1/4" Drive 6 Point Deep SAE Socket 1/4"	80366	3/8" Drive 6 Point Deep SAE Socket 7/16"	80627	1/2" Drive 6 Point Standard Metric Socket 15mm
80118	1/4" Drive 6 Point Deep SAE Socket 9/32"	80367	3/8" Drive 6 Point Deep SAE Socket 1/2"	80628	1/2" Drive 6 Point Standard Metric Socket 16mm
80119	1/4" Drive 6 Point Deep SAE Socket 5/16"	80368	3/8" Drive 6 Point Deep SAE Socket 9/16"	80629	1/2" Drive 6 Point Standard Metric Socket 17mm
80120D	1/4" Drive 6 Point Deep SAE Socket 11/32"	80369	3/8" Drive 6 Point Deep SAE Socket 5/8"	80630	1/2" Drive 6 Point Standard Metric Socket 18mm
80121	1/4" Drive 6 Point Deep SAE Socket 3/8"	80370D	3/8" Drive 6 Point Deep SAE Socket 11/16"	80631	1/2" Drive 6 Point Standard Metric Socket 19mm
80122D	1/4" Drive 6 Point Deep SAE Socket 7/16"	80371	3/8" Drive 6 Point Deep SAE Socket 3/4"	80632	1/2" Drive 6 Point Standard Metric Socket 20mm
80123	1/4" Drive 6 Point Deep SAE Socket 1/2"	80372	3/8" Drive 6 Point Deep SAE Socket 13/16"	80633	1/2" Drive 6 Point Standard Metric Socket 21mm
80124	1/4" Drive 6 Point Deep SAE Socket 9/16"	80373	3/8" Drive 6 Point Deep SAE Socket 7/8"	80634	1/2" Drive 6 Point Standard Metric Socket 22mm
80125	1/4" Drive 6 Point Standard Metric Socket 4mm	80374	3/8" Drive 6 Point Standard Metric Socket 6mm	80635	1/2" Drive 6 Point Standard Metric Socket 23mm
80126	1/4" Drive 6 Point Standard Metric Socket 5mm	80375	3/8" Drive 6 Point Standard Metric Socket 7mm	80636D	1/2" Drive 6 Point Standard Metric Socket 24mm
80127	1/4" Drive 6 Point Standard Metric Socket 5.5mm	80376	3/8" Drive 6 Point Standard Metric Socket 8mm	80402	3/8" Drive Spark Plug Socket 5/8"
80128	1/4" Drive 6 Point Standard Metric Socket 6mm	80377	3/8" Drive 6 Point Standard Metric Socket 9mm	80403	3/8" Drive Spark Plug Socket 13/16"
80129	1/4" Drive 6 Point Standard Metric Socket 7mm	80378	3/8" Drive 6 Point Standard Metric Socket 10mm	80100	1/4" Drive Universal Joint
80130	1/4" Drive 6 Point Standard Metric Socket 8mm	80379	3/8" Drive 6 Point Standard Metric Socket 11mm	80549	3/8" Drive Universal Joint
80131D	1/4" Drive 6 Point Standard Metric Socket 9mm	80380	3/8" Drive 6 Point Standard Metric Socket 12mm	80600D	1/2" Drive Universal Joint
80132	1/4" Drive 6 Point Standard Metric Socket 10mm	80381	3/8" Drive 6 Point Standard Metric Socket 13mm		
80133	1/4" Drive 6 Point Standard Metric Socket 11mm	80382	3/8" Drive 6 Point Standard Metric Socket 14mm		
80134	1/4" Drive 6 Point Standard Metric Socket 12mm	80383	3/8" Drive 6 Point Standard Metric Socket 15mm		
80135D	1/4" Drive 6 Point Standard Metric Socket 13mm	80384	3/8" Drive 6 Point Standard Metric Socket 16mm		

GEARWRENCH® Career Builder Diesel Add-on TEP Set

- Sockets – 1/2" Drive in Deep SAE and Metric Sizes
- Wrenches – Long Pattern Combination in SAE and Metric Sizes
- Flare Nut Wrenches – SAE and Metric
- Flex Handle – 1/2" Drive
- Heavy-Duty Oil Filter Wrenches
- General Purpose Tools – Pry Bar, Groove Joint Pliers, Adjustable Wrench



Cat. No.	UPC No.	Description
83092	099575830921	Career Builder Diesel Add-on TEP Set

Cat. No.	Description	Cat. No.	Description	Cat. No.	Description
2320D	Heavy Duty Oil Filter Wrench (3-3/4" to 4-1/2")	81646	13 x 14mm Flare Nut Wrench	80617	1/2" Drive 6 Point Deep SAE Socket 11/16"
2321	Heavy Duty Oil Filter Wrench (4-1/2" to 5-1/4")	81647	15 x 17mm Flare Nut Wrench	80618	1/2" Drive 6 Point Deep SAE Socket 3/4"
2322D	Heavy Duty Oil Filter Wrench (5-1/4" to 5-3/4")	81648	16 x 18mm Flare Nut Wrench	80619	1/2" Drive 6 Point Deep SAE Socket 13/16"
82020D	12" Groove Joint Pliers with Straight Jaw	81649	19 x 21mm Flare Nut Wrench	80620	1/2" Drive 6 Point Deep SAE Socket 7/8"
82220	29" Extendable Indexing Pry Bar	81733	1-1/16" Long Pattern Combination Wrench	80621	1/2" Drive 6 Point Deep SAE Socket 15/16"
81893	12" Adjustable Wrench with Cushion Grip	81734	1-1/8" Long Pattern Combination Wrench	80637	1/2" Drive 6 Point Deep Metric Socket 10mm
81307	1/2" Drive Full Polish Flex Handle 15"	81735	1-1/4" Long Pattern Combination Wrench	80638	1/2" Drive 6 Point Deep Metric Socket 11mm
81680	1/4" x 5/16" Flare Nut Wrench	81741	23mm Long Pattern Combination Wrench	80639	1/2" Drive 6 Point Deep Metric Socket 12mm
81681	3/8" x 7/16" Flare Nut Wrench	81742	24mm Long Pattern Combination Wrench	80640	1/2" Drive 6 Point Deep Metric Socket 13mm
81682	1/2" x 9/16" Flare Nut Wrench	81743	27mm Long Pattern Combination Wrench	80641	1/2" Drive 6 Point Deep Metric Socket 14mm
81683	5/8" x 11/16" Flare Nut Wrench	81744	30mm Long Pattern Combination Wrench	80642	1/2" Drive 6 Point Deep Metric Socket 15mm
81684	5/8" x 3/4" Flare Nut Wrench	81745D	32mm Long Pattern Combination Wrench	80643	1/2" Drive 6 Point Deep Metric Socket 16mm
81685	3/4" x 7/8" Flare Nut Wrench	80614	1/2" Drive 6 Point Deep SAE Socket 1/2"	80644	1/2" Drive 6 Point Deep Metric Socket 17mm
81644	9 x 11mm Flare Nut Wrench	80615	1/2" Drive 6 Point Deep SAE Socket 9/16"	80645	1/2" Drive 6 Point Deep Metric Socket 18mm
81645	10 x 12mm Flare Nut Wrench	80616	1/2" Drive 6 Point Deep SAE Socket 5/8"	80646D	1/2" Drive 6 Point Deep Metric Socket 19mm

GEARWRENCH® Career Builder Auto Body Add-on TEP Set

- Hammer and Dolly Set – 7 Pc.
- Door Pad & Panel Remover Kit – 4 Pc.
- Hook and Pick Set – 7 Pc.
- Torx® Bit Socket Set
- Specialty Tools – Window Molding, Trim Pad Remover Tools, Door Handle Window Lift Remover, Push Pin Pliers, Scraper Tool, and More



Cat. No.	UPC No.	Description
83093	099575830938	Career Builder Auto Body Add-on TEP Set

Cat. No.	Description	Cat. No.	Description	Cat. No.	Description
431D	Door Handle and Window Lift Remover	3725	Wedge Dolly	80172	1/4" Drive TORX® Press Fit Bit Socket, T-10
2038D	Window Molding Remover	3729	Push Pin Removal Pliers - 30°	80173	1/4" Drive TORX® Press Fit Bit Socket, T-15
2106	All-Purpose Scraper and Sticker Remover	84001D	5" Cotter Pin Puller	80174	1/4" Drive TORX® Press Fit Bit Socket, T-20
2311D	Shoe Handle Wire Scratch Brush	84002D	4" Hose Pick Puller	80175	1/4" Drive TORX® Press Fit Bit Socket, T-25
2425D	1-1/4" Scraper	84003D	4-1/2" Awl	80176D	1/4" Drive TORX® Press Fit Bit Socket, T-27
2426D	3" Scraper	84004D	3-1/8" Mini Full Hook	80177D	1/4" Drive TORX® Press Fit Bit Socket, T-30
2822D	Trim Pad Removing Tool	84005	3-1/8" 90° Mini Hook	80171	1/4" Drive TORX® Press Fit Bit Socket, T-8
3718D	Smooth Faced Cross Chisel Hammer	84006	3-1/8" Straight Mini Hook	80451	3/8" Drive TORX® Press-Fit Bit Socket, T-40
3719	Smooth Faced Bumping Hammer with Square & Round Face	84007	3-1/8" Mini Offset Hook	80452	3/8" Drive TORX® Press-Fit Bit Socket, T-45
3720	Crossed Face Shrinking Hammer	84051	4" V-Notch Puller	80453	3/8" Drive TORX® Press-Fit Bit Socket, T-47
3722	Toe Dolly	84052	4" Square Notch Puller	80454	3/8" Drive TORX® Press-Fit Bit Socket, T-50
3723	Heel Dolly	84053	4" Scraper	80455	3/8" Drive TORX® Press-Fit Bit Socket, T-55
3724	General Purpose Dolly	84054D	4" Curved Blade V-Notch Puller	80667	1/2" Drive TORX® Press Fit Bit Socket, T-60

GEARWRENCH® Career Builder HVAC Add-on TEP Set

- Flex Flare Nut Wrench Sets – 5 Pc. SAE and 6 Pc. Metric
- HVAC QuadBox™– 2 Sizes
- Adjustable Wrench Set – 3 Pc.
- Nut Driver Set – 7 Pc. SAE
- Wiss® Snips – 3 Pc. Set
- Tubing Service Set – Including Tubing Cutter, Deburring Tool, Tubing Bender and Flaring Tools
- Specialty Tools – Hammer, Pipe Wrench, Manifold Set, Torpedo Level, Wire Stripper/Crimper



Cat. No.	UPC No.	Description
83094*	099575830945	Career Builder HVAC Add-on TEP Set

* Please Note: Most tools GearWrench branded. May include other leading Apex Tool Group brands.

Cat. No.	Description	Cat. No.	Description	Cat. No.	Description
29-426	Vinyl Roll 7 Pockets	-	9" Level	81694	Flex Flare Nut Wrench 3/8" x 7/16"
69-350	Curved Claw Hammer, Fiberglass Handle 20 oz.	-	A/C Manifold Gauge Set	81695	Flex Flare Nut Wrench 1/2" x 9/16"
2107D	Mini Tubing Cutter	66-808	Acetate Hollow Shaft Nutdriver 1/4 x 3"	81696	Flex Flare Nut Wrench 5/8" x 11/16"
2162D	Electrical Wire Stripper and Crimper	66-809	Acetate Hollow Shaft Nutdriver 9/32 x 3"	81697	Flex Flare Nut Wrench 3/4" x 7/8"
2189D	Tubing Bender	66-810	Acetate Hollow Shaft Nutdriver 5/16 x 3"	81686	Flex Flare Nut Wrench 9x11mm
3457	Tubing Cutter	66-811	Acetate Hollow Shaft Nutdriver 11/32 x 3"	81687	Flex Flare Nut Wrench 10x12mm
3905D	Deburring Tool	66-812	Acetate Hollow Shaft Nutdriver 3/8 x 3"	81688	Flex Flare Nut Wrench 13x14mm
41594	7 Pc. Flaring Adapter Kit	66-814	Acetate Hollow Shaft Nutdriver 7/16 x 3"	81689	Flex Flare Nut Wrench 15x17mm
41595	Holding Bar	66-816	Acetate Hollow Shaft Nutdriver 1/2 x 3"	81690	Flex Flare Nut Wrench 16x18mm
41596	Yoke For Flaring Tool	81890	6" Adjustable Wrench w/Cushion Grip	81692	Flex Flare Nut Wrench 19x21mm
M1R	9-3/4" Compound Action Snips, Cuts Straight to Left	81891	8" Adjustable Wrench with Cushion Grip	73-014	Pipe Wrench 14"
M2R	9-3/4" Compound Action Snips, Cuts Straight to Right	81892	10" Adjustable Wrench w/Cushion Grip	85220D	HVAC QuadBox 1/4" x 3/16" (Square) & 3/8" x 5/16" (Square)
M3R	9-3/4" Compound Action Snips, Straight, Left, Right	81693	Flex Flare Nut Wrench 1/4" x 5/16"	85221	HVAC QuadBox 1/4" x 3/16" (Square) & 9/16" x 1/2" (Hex)

GEARWRENCH® Intermediate Auto TEP Set

- 84-Tooth 1/4", 3/8" and 1/2" Drive Ratchets
- Extensions – 1/4", 3/8" and 1/2"
- Universal Joints – 1/4", 3/8" and 1/2"
- Sockets – 1/4" and 3/8" Drive in Standard and Deep, SAE and Metric, 1/2" Drive in Standard Length SAE and Metric
- Wrenches – Long Pattern Combination in SAE and Metric Sizes
- Screwdrivers – 12 Pc. Set
- Pliers – 7 Pc. Set and Double-X, Punches and Chisels – 12 Pc. Set
- ALLEN® Hex Key Set – 13 Pc. SAE, 9 Pc. Metric
- General Purpose Tools – Hacksaw, Hammers, Utility Knife, Flashlight, Locking Pliers, Safety Glasses, Tape Measure
- Automotive Specialty Tools – Low Voltage Circuit Tester, Feeler Gauge, Gasket Scraper, Screw Starters, Brake Tools, Inspection Tools, and More



Cat. No.	UPC No.	Description
83095*	099575830952	Intermediate Auto TEP Set

* Please Note: Most tools GearWrench branded. May include other leading Apex Tool Group brands.

Cat. No.	Description	Cat. No.	Description	Cat. No.	Description
129D	Low-Voltage Circuit Tester	80965	12" Cushion Grip High Tension Hacksaw Frame	82255	3 lb Drilling Hammer
162D	Feeler Gauge	82005D	Straight Double-X™ Pliers	82259	16 oz Rubber Mallet - Wood Hickory Handle
2162D	Electrical Wire Stripper and Crimper	82011	9-1/2" Tongue and Groove Pliers	82260	12 oz Soft Face Hammer, Removable Caps
2593	Pocket Telescoping Magnetic Pickup Tool	82012	7" Diagonal Cutting Pliers	82261	1/4" x 4-3/4" x 1/4" Cold Chisel
2774D	Universal Brake Shoe Retaining Spring Tool	82013	8" Long Nose Pliers	82262	3/8" x 5" x 5/16" Cold Chisel
2840D	1-1/4" Round Magnifying Mirror with Pocket Clip	82014	8" Slip Joint Pliers	82264	1/2" x 6" x 3/8" Cold Chisel
295D	Drum Brake Adjusting Tool	82020D	12" Groove Joint Pliers with Straight Jaw	82265	5/8" x 6-1/2" x 3/8" Cold Chisel
298D	Brake Spring Pliers	82025	8" Lineman Pliers	82270	3/8" x 5" Center Punch
3151	Universal Convertible Retaining Ring Pliers, Large	82028	8" End Cutting Nipper Pliers	82272	3/32" x 4-3/4" x 5/16" Pin Punch
3163D	Disc Brake Piston Tool	82251	16 oz Ball Pein Hammer - Fiberglass	82273	1/8" x 5" x 5/16" Pin Punch

Contents continued on next page.

1 MASTER SETS

Cat. No.	Description	Cat. No.	Description	Cat. No.	Description
82274	5/32" x 5-1/4" x 5/16" Pin Punch	81672	15mm Long Pattern Combination Wrench	80363	3/8" Drive 6 Point Deep SAE Socket 1/4"
82275	3/16" x 5-1/2" x 5/16" Pin Punch	81673	16mm Long Pattern Combination Wrench	80364	3/8" Drive 6 Point Deep SAE Socket 5/16"
82278	1/8" x 8" x 3/8" Long Taper Punch	81674	17mm Long Pattern Combination Wrench	80365	3/8" Drive 6 Point Deep SAE Socket 3/8"
82283	3/16" x 5" x 3/8" Starter Punch	81675	18mm Long Pattern Combination Wrench	80366	3/8" Drive 6 Point Deep SAE Socket 7/16"
82285	1/8" x 4-1/2" x 5/16" Starter	81676	19mm Long Pattern Combination Wrench	80367	3/8" Drive 6 Point Deep SAE Socket 1/2"
82881	Folding Utility Knife	81677	20mm Long Pattern Combination Wrench	80368	3/8" Drive 6 Point Deep SAE Socket 9/16"
83132	LED Flashlight with Carry Case	81678	21mm Long Pattern Combination Wrench	80369	3/8" Drive 6 Point Deep SAE Socket 5/8"
84083	1" Wide Scraper Long	81679	22mm Long Pattern Combination Wrench	80370D	3/8" Drive 6 Point Deep SAE Socket 11/16"
C10CV	10" Curved Jaw Locking Plier With Wire Cutter	81011F	1/4" Drive Full Polish Teardrop Ratchet	80371	3/8" Drive 6 Point Deep SAE Socket 3/4"
C5CV	5" Curved Jaw Locking Plier With Wire Cutter	81211F	3/8" Drive Full Polish Teardrop Ratchet	80372	3/8" Drive 6 Point Deep SAE Socket 13/16"
C6NV	6" Long Nose Locking Plier With Wire Cutter	81304F	1/2" Drive Full Polish Teardrop Ratchet	80373	3/8" Drive 6 Point Deep SAE Socket 7/8"
-	Safety Glasses	80105	1/4" Drive 6 Point Standard SAE Socket 3/16"	80374	3/8" Drive 6 Point Standard Metric Socket 6mm
PS3316	3/4" x 16' Pro Series 3000 Power Return Tape	80106	1/4" Drive 6 Point Standard SAE Socket 7/32"	80375	3/8" Drive 6 Point Standard Metric Socket 7mm
2283	Phillips Screw Starter	80107	1/4" Drive 6 Point Standard SAE Socket 1/4"	80376	3/8" Drive 6 Point Standard Metric Socket 8mm
80000	Dual Material Phillips® Screwdriver #0 x 2-1/2"	80108	1/4" Drive 6 Point Standard SAE Socket 9/32"	80377	3/8" Drive 6 Point Standard Metric Socket 9mm
80001	Dual Material Phillips® Screwdriver #1 x 3"	80109	1/4" Drive 6 Point Standard SAE Socket 5/16"	80378	3/8" Drive 6 Point Standard Metric Socket 10mm
80004	Dual Material Phillips® Screwdriver #1 x 6"	80110	1/4" Drive 6 Point Standard SAE Socket 11/32"	80379	3/8" Drive 6 Point Standard Metric Socket 11mm
80005	Dual Material Phillips® Screwdriver #2 x 1-1/2"	80111	1/4" Drive 6 Point Standard SAE Socket 3/8"	80380	3/8" Drive 6 Point Standard Metric Socket 12mm
80007	Dual Material Phillips® Screwdriver #2 x 4"	80112	1/4" Drive 6 Point Standard SAE Socket 7/16"	80381	3/8" Drive 6 Point Standard Metric Socket 13mm
80011	Dual Material Phillips® Screwdriver #3 x 6"	80113D	1/4" Drive 6 Point Standard SAE Socket 1/2"	80382	3/8" Drive 6 Point Standard Metric Socket 14mm
2282D	Slotted Screw Starter	80114D	1/4" Drive 6 Point Standard SAE Socket 9/16"	80383	3/8" Drive 6 Point Standard Metric Socket 15mm
80012D	Dual Material Slotted Screwdriver 1/4 x 1-1/2"	80115	1/4" Drive 6 Point Deep SAE Socket 3/16"	80384	3/8" Drive 6 Point Standard Metric Socket 16mm
80013	Dual Material Slotted Screwdriver 1/4 x 4"	80116D	1/4" Drive 6 Point Deep SAE Socket 7/32"	80385	3/8" Drive 6 Point Standard Metric Socket 17mm
80014	Dual Material Slotted Screwdriver 1/4 x 6"	80117	1/4" Drive 6 Point Deep SAE Socket 1/4"	80386	3/8" Drive 6 Point Standard Metric Socket 18mm
80018D	Dual Material Slotted Screwdriver 3/16 x 6"	80118	1/4" Drive 6 Point Deep SAE Socket 9/32"	80387	3/8" Drive 6 Point Standard Metric Socket 19mm
80022	Dual Material Slotted Screwdriver 3/8 x 8"	80119	1/4" Drive 6 Point Deep SAE Socket 5/16"	80388	3/8" Drive 6 Point Deep Metric Socket 6mm
80023	Dual Material Slotted Screwdriver 5/16 x 6"	80120D	1/4" Drive 6 Point Deep SAE Socket 11/32"	80389	3/8" Drive 6 Point Deep Metric Socket 7mm
56615G	9 Piece Long Arm Metric Ball-Plus™ Hex Key Set	80121	1/4" Drive 6 Point Deep SAE Socket 3/8"	80390	3/8" Drive 6 Point Deep Metric Socket 8mm
56603G	13 Piece Long Arm SAE Hex Key Set	80122D	1/4" Drive 6 Point Deep SAE Socket 7/16"	80391	3/8" Drive 6 Point Deep Metric Socket 9mm
81128	1/4" Socket Driver	80123	1/4" Drive 6 Point Deep SAE Socket 1/2"	80392	3/8" Drive 6 Point Deep Metric Socket 10mm
80172	1/4" Drive TORX® Press Fit Bit Socket, T-10	80124	1/4" Drive 6 Point Deep SAE Socket 9/16"	80393D	3/8" Drive 6 Point Deep Metric Socket 11mm
80173	1/4" Drive TORX® Press Fit Bit Socket, T-15	80125	1/4" Drive 6 Point Standard Metric Socket 4mm	80394D	3/8" Drive 6 Point Deep Metric Socket 12mm
80174	1/4" Drive TORX® Press Fit Bit Socket, T-20	80126	1/4" Drive 6 Point Standard Metric Socket 5mm	80395	3/8" Drive 6 Point Deep Metric Socket 13mm
80175	1/4" Drive TORX® Press Fit Bit Socket, T-25	80127	1/4" Drive 6 Point Standard Metric Socket 5.5mm	80396	3/8" Drive 6 Point Deep Metric Socket 14mm
80176D	1/4" Drive TORX® Press Fit Bit Socket, T-27	80128	1/4" Drive 6 Point Standard Metric Socket 6mm	80397	3/8" Drive 6 Point Deep Metric Socket 15mm
80177D	1/4" Drive TORX® Press Fit Bit Socket, T-30	80129	1/4" Drive 6 Point Standard Metric Socket 7mm	80398	3/8" Drive 6 Point Deep Metric Socket 16mm
80171	1/4" Drive TORX® Press Fit Bit Socket, T-8	80130	1/4" Drive 6 Point Standard Metric Socket 8mm	80399	3/8" Drive 6 Point Deep Metric Socket 17mm
80451	3/8" Drive TORX® Press-Fit Bit Socket, T-40	80131D	1/4" Drive 6 Point Standard Metric Socket 9mm	80400	3/8" Drive 6 Point Deep Metric Socket 18mm
80452	3/8" Drive TORX® Press-Fit Bit Socket, T-45	80132	1/4" Drive 6 Point Standard Metric Socket 10mm	80401	3/8" Drive 6 Point Deep Metric Socket 19mm
80453	3/8" Drive TORX® Press-Fit Bit Socket, T-47	80133	1/4" Drive 6 Point Standard Metric Socket 11mm	80603	1/2" Drive 6 Point Standard SAE Socket 1/2"
80454	3/8" Drive TORX® Press-Fit Bit Socket, T-50	80134	1/4" Drive 6 Point Standard Metric Socket 12mm	80604	1/2" Drive 6 Point Standard SAE Socket 9/16"
80455	3/8" Drive TORX® Press-Fit Bit Socket, T-55	80135D	1/4" Drive 6 Point Standard Metric Socket 13mm	80605	1/2" Drive 6 Point Standard SAE Socket 5/8"
80667	1/2" Drive TORX® Press Fit Bit Socket, T-60	80136	1/4" Drive 6 Point Standard Metric Socket 14mm	80606	1/2" Drive 6 Point Standard SAE Socket 11/16"
81307	1/2" Drive Full Polish Flex Handle 15"	80137	1/4" Drive 6 Point Standard Metric Socket 15mm	80607D	1/2" Drive 6 Point Standard SAE Socket 3/4"
81113D	1/4" Drive Standard Extension 3"	80138	1/4" Drive 6 Point Deep Metric Socket 4mm	80608	1/2" Drive 6 Point Standard SAE Socket 13/16"
81241	3/8" Drive Standard Extension 3"	80139	1/4" Drive 6 Point Deep Metric Socket 5mm	80609	1/2" Drive 6 Point Standard SAE Socket 7/8"
81242	3/8" Drive Standard Extension 6"	80140	1/4" Drive 6 Point Deep Metric Socket 5.5mm	80610D	1/2" Drive 6 Point Standard SAE Socket 15/16"
81341	1/2" Drive Standard Extension 5"	80141	1/4" Drive 6 Point Deep Metric Socket 6mm	80611	1/2" Drive 6 Point Standard SAE Socket 1"
81650	1/4" Long Pattern Combination Wrench	80142	1/4" Drive 6 Point Deep Metric Socket 7mm	80612	1/2" Drive 6 Point Standard SAE Socket 1-1/16"
81651D	9/32" Long Pattern Combination Wrench	80143	1/4" Drive 6 Point Deep Metric Socket 8mm	80613	1/2" Drive 6 Point Standard SAE Socket 1-1/8"
81652D	5/16" Long Pattern Combination Wrench	80144	1/4" Drive 6 Point Deep Metric Socket 9mm	80624	1/2" Drive 6 Point Standard Metric Socket 12mm
81653	11/32" Long Pattern Combination Wrench	80145	1/4" Drive 6 Point Deep Metric Socket 10mm	80625	1/2" Drive 6 Point Standard Metric Socket 13mm
81654	3/8" Long Pattern Combination Wrench	80146D	1/4" Drive 6 Point Deep Metric Socket 11mm	80626D	1/2" Drive 6 Point Standard Metric Socket 14mm
81655	7/16" Long Pattern Combination Wrench	80147	1/4" Drive 6 Point Deep Metric Socket 12mm	80627	1/2" Drive 6 Point Standard Metric Socket 15mm
81656	1/2" Long Pattern Combination Wrench	80148	1/4" Drive 6 Point Deep Metric Socket 13mm	80628	1/2" Drive 6 Point Standard Metric Socket 16mm
81657	9/16" Long Pattern Combination Wrench	80149	1/4" Drive 6 Point Deep Metric Socket 14mm	80629	1/2" Drive 6 Point Standard Metric Socket 17mm
81658	5/8" Long Pattern Combination Wrench	80150	1/4" Drive 6 Point Deep Metric Socket 15mm	80630	1/2" Drive 6 Point Standard Metric Socket 18mm
81659	11/16" Long Pattern Combination Wrench	80350	3/8" Drive 6 Point Standard SAE Socket 1/4"	80631	1/2" Drive 6 Point Standard Metric Socket 19mm
81660	3/4" Long Pattern Combination Wrench	80351	3/8" Drive 6 Point Standard SAE Socket 5/16"	80632	1/2" Drive 6 Point Standard Metric Socket 20mm
81661	13/16" Long Pattern Combination Wrench	80352	3/8" Drive 6 Point Standard SAE Socket 3/8"	80633	1/2" Drive 6 Point Standard Metric Socket 21mm
81662	7/8" Long Pattern Combination Wrench	80353	3/8" Drive 6 Point Standard SAE Socket 7/16"	80634	1/2" Drive 6 Point Standard Metric Socket 22mm
81663	15/16" Long Pattern Combination Wrench	80354	3/8" Drive 6 Point Standard SAE Socket 1/2"	80635	1/2" Drive 6 Point Standard Metric Socket 23mm
81664	1" Long Pattern Combination Wrench	80355	3/8" Drive 6 Point Standard SAE Socket 9/16"	80636D	1/2" Drive 6 Point Standard Metric Socket 24mm
81665	8mm Long Pattern Combination Wrench	80356	3/8" Drive 6 Point Standard SAE Socket 5/8"	80402	3/8" Drive Spark Plug Socket 5/8"
81666	9mm Long Pattern Combination Wrench	80357	3/8" Drive 6 Point Standard SAE Socket 11/16"	80403	3/8" Drive Spark Plug Socket 13/16"
81667	10mm Long Pattern Combination Wrench	80358	3/8" Drive 6 Point Standard SAE Socket 3/4"	80100	1/4" Drive Universal Joint
81668	11mm Long Pattern Combination Wrench	80359	3/8" Drive 6 Point Standard SAE Socket 13/16"	80549	3/8" Drive Universal Joint
81669	12mm Long Pattern Combination Wrench	80360	3/8" Drive 6 Point Standard SAE Socket 7/8"	80600D	1/2" Drive Universal Joint
81670	13mm Long Pattern Combination Wrench	80361	3/8" Drive 6 Point Standard SAE Socket 15/16"		
81671	14mm Long Pattern Combination Wrench	80362	3/8" Drive 6 Point Standard SAE Socket 1"		

GEARWRENCH® Intermediate Auto Body TEP Set

- 84-Tooth 1/4", 3/8" and 1/2" Drive Ratchets
- Extensions – 1/4", 3/8" and 1/2" Drive
- Universal Joint – 1/4", 3/8" and 1/2" Drive
- Sockets – 1/4" and 3/8" Drive in in Standard and Deep, SAE and Metric, 1/2" Drive in Standard Length SAE and Metric
- Wrenches – Long Pattern Combination in SAE and Metric Sizes
- Screwdrivers – 12 Pc. Set, Master Torx® Bit Socket Set
- Pliers – 4 Pc. Set and Double-X, Punches and Chisels – 12 Pc. Set
- ALLEN® Hex Key Set – 13 Pc. SAE
- General Purpose Tools – Hacksaw, Hammers, Utility Knife, Flashlight, Locking Pliers, Safety Glasses, Tape Measure
- Automotive Specialty Tools – Low Voltage Circuit Tester, Gasket Scraper, Inspection Tools, Body Tools, and More



Cat. No.	UPC No.	Description
83097*	099575830976	Intermediate Auto Body TEP Set

* Please Note: Most tools GearWrench branded. May include other leading Apex Tool Group brands.

Cat. No.	Description	Cat. No.	Description	Cat. No.	Description
129D	Low-Voltage Circuit Tester	82012	7" Diagonal Cutting Pliers	83132	LED Flashlight with Carry Case
2038D	Window Molding Remover	82013	8" Long Nose Pliers	84001D	5" Cotter Pin Puller
2106	All-Purpose Scraper and Sticker Remover	82014	8" Slip Joint Pliers	84002D	4" Hose Pick Puller
2162D	Electrical Wire Stripper and Crimper	82251	16 oz Ball Pein Hammer - Fiberglass	84003D	4-1/2" Awl
2311D	Shoe Handle Wire Scratch Brush	82255	3 lb Drilling Hammer	84004D	3-1/8" Mini Full Hook
2425D	1-1/4" Scraper	82259	16 oz Rubber Mallet - Wood Hickory Handle	84005	3-1/8" 90° Mini Hook
2426D	3" Scraper	82260	12 oz Soft Face Hammer, Removable Caps	84006	3-1/8" Straight Mini Hook
2593	Pocket Telescoping Magnetic Pickup Tool	82261	1/4" x 4-3/4" x 1/4" Cold Chisel	84007	3-1/8" Mini Offset Hook
2822D	Trim Pad Removing Tool	82262	3/8" x 5" x 5/16" Cold Chisel	84051	4" V-Notch Puller
2840D	1-1/4" Round Magnifying Mirror with Pocket Clip	82264	1/2" x 6" x 3/8" Cold Chisel	84052	4" Square Notch Puller
2979	Scriber	82265	5/8" x 6-1/2" x 3/8" Cold Chisel	84053	4" Scraper
3151	Universal Convertible Retaining Ring Pliers, Large	82270	3/8" x 5" Center Punch	84054D	4" Curved Blade V-Notch Puller
3718D	Smooth Faced Cross Chisel Hammer	82272	3/32" x 4-3/4" x 5/16" Pin Punch	84083	1" Wide Scraper Long
3719	Smooth Faced Bumping Hammer with Square & Round Face	82273	1/8" x 5" x 5/16" Pin Punch	C10CV	10" Curved Jaw Locking Plier With Wire Cutter
3720	Crossed Face Shrinking Hammer	82274	5/32" x 5-1/4" x 5/16" Pin Punch	C11CCSV	11" Locking C-Clamp With Swivel Pads
3722	Toe Dolly	82275	3/16" x 5-1/2" x 5/16" Pin Punch	C6NV	6" Long Nose Locking Plier With Wire Cutter
3724	General Purpose Dolly	82278	1/8" x 8" x 3/8" Long Taper Punch	M3R	9-3/4" Compound Action Snips, Straight, Left, Right
3725	Wedge Dolly	82283	3/16" x 5" x 3/8" Starter Punch	-	Safety Glasses
3729	Push Pin Removal Pliers - 30°	82285	1/8" x 4-1/2" x 5/16" Starter	PS3316	3/4" x 16" Pro Series 3000 Power Return Tape
431D	Door Handle and Window Lift Remover	82822D	8" Flat Bastard File	80000	Dual Material Phillips® Screwdriver #0 x 2-1/2"
80965	12" Cushion Grip High Tension Hacksaw Frame	82823	8" Round Bastard File	80001	Dual Material Phillips® Screwdriver #1 x 3"
82005D	Straight Double-X™ Pliers	82824	8" Half Round Bastard File	80004	Dual Material Phillips® Screwdriver #1 x 6"
82011	9-1/2" Tongue and Groove Pliers	82825	8" Triangle Bastard File	80005	Dual Material Phillips® Screwdriver #2 x 1-1/2"
		82881	Folding Utility Knife	80007	Dual Material Phillips® Screwdriver #2 x 4"

Contents continued on next page.

1
M A S T E R S E T S

Cat. No.	Description	Cat. No.	Description	Cat. No.	Description
80011	Dual Material Phillips® Screwdriver #3 x 6"	81679	22mm Long Pattern Combination Wrench	80366	3/8" Drive 6 Point Deep SAE Socket 7/16"
80012D	Dual Material Slotted Screwdriver 1/4 x 1-1/2"	81011F	1/4" Drive Full Polish Teardrop Ratchet	80367	3/8" Drive 6 Point Deep SAE Socket 1/2"
80013	Dual Material Slotted Screwdriver 1/4 x 4"	81211F	3/8" Drive Full Polish Teardrop Ratchet	80368	3/8" Drive 6 Point Deep SAE Socket 9/16"
80014	Dual Material Slotted Screwdriver 1/4 x 6"	81304F	1/2" Drive Full Polish Teardrop Ratchet	80369	3/8" Drive 6 Point Deep SAE Socket 5/8"
80018D	Dual Material Slotted Screwdriver 3/16 x 6"	80105	1/4" Drive 6 Point Standard SAE Socket 3/16"	80370D	3/8" Drive 6 Point Deep SAE Socket 11/16"
80022	Dual Material Slotted Screwdriver 3/8 x 8"	80106	1/4" Drive 6 Point Standard SAE Socket 7/32"	80371	3/8" Drive 6 Point Deep SAE Socket 3/4"
80023	Dual Material Slotted Screwdriver 5/16 x 6"	80107	1/4" Drive 6 Point Standard SAE Socket 1/4"	80372	3/8" Drive 6 Point Deep SAE Socket 13/16"
56603G	13 Piece Long Arm SAE Hex Key Set	80108	1/4" Drive 6 Point Standard SAE Socket 9/32"	80373	3/8" Drive 6 Point Deep SAE Socket 7/8"
81128	1/4" Socket Driver	80109	1/4" Drive 6 Point Standard SAE Socket 5/16"	80374	3/8" Drive 6 Point Standard Metric Socket 6mm
80172	1/4" Drive TORX® Press Fit Bit Socket, T-10	80110	1/4" Drive 6 Point Standard SAE Socket 11/32"	80375	3/8" Drive 6 Point Standard Metric Socket 7mm
80173	1/4" Drive TORX® Press Fit Bit Socket, T-15	80111	1/4" Drive 6 Point Standard SAE Socket 3/8"	80376	3/8" Drive 6 Point Standard Metric Socket 8mm
80174	1/4" Drive TORX® Press Fit Bit Socket, T-20	80112	1/4" Drive 6 Point Standard SAE Socket 7/16"	80377	3/8" Drive 6 Point Standard Metric Socket 9mm
80175	1/4" Drive TORX® Press Fit Bit Socket, T-25	80113D	1/4" Drive 6 Point Standard SAE Socket 1/2"	80378	3/8" Drive 6 Point Standard Metric Socket 10mm
80176D	1/4" Drive TORX® Press Fit Bit Socket, T-27	80114D	1/4" Drive 6 Point Standard SAE Socket 9/16"	80379	3/8" Drive 6 Point Standard Metric Socket 11mm
80177D	1/4" Drive TORX® Press Fit Bit Socket, T-30	80115	1/4" Drive 6 Point Deep SAE Socket 3/16"	80380	3/8" Drive 6 Point Standard Metric Socket 12mm
80416	3/8" Drive Hex Bit Socket, 5/32"	80116D	1/4" Drive 6 Point Deep SAE Socket 7/32"	80381	3/8" Drive 6 Point Standard Metric Socket 13mm
80417	3/8" Drive Hex Bit Socket, 3/16"	80117	1/4" Drive 6 Point Deep SAE Socket 1/4"	80382	3/8" Drive 6 Point Standard Metric Socket 14mm
80418	3/8" Drive Hex Bit Socket, 7/32"	80118	1/4" Drive 6 Point Deep SAE Socket 9/32"	80383	3/8" Drive 6 Point Standard Metric Socket 15mm
80419	3/8" Drive Hex Bit Socket, 1/4"	80119	1/4" Drive 6 Point Deep SAE Socket 5/16"	80384	3/8" Drive 6 Point Standard Metric Socket 16mm
80420	3/8" Drive Hex Bit Socket, 5/16"	80120D	1/4" Drive 6 Point Deep SAE Socket 11/32"	80385	3/8" Drive 6 Point Standard Metric Socket 17mm
80421	3/8" Drive Hex Bit Socket, 3/8"	80121	1/4" Drive 6 Point Deep SAE Socket 3/8"	80386	3/8" Drive 6 Point Standard Metric Socket 18mm
80422	3/8" Drive Hex Bit Socket, 2mm	80122D	1/4" Drive 6 Point Deep SAE Socket 7/16"	80387	3/8" Drive 6 Point Standard Metric Socket 19mm
80423	3/8" Drive Hex Bit Socket, 2.5mm	80123	1/4" Drive 6 Point Deep SAE Socket 1/2"	80388	3/8" Drive 6 Point Deep Metric Socket 6mm
80424	3/8" Drive Hex Bit Socket, 3mm	80124	1/4" Drive 6 Point Deep SAE Socket 9/16"	80389	3/8" Drive 6 Point Deep Metric Socket 7mm
80425	3/8" Drive Hex Bit Socket, 4mm	80125	1/4" Drive 6 Point Standard Metric Socket 4mm	80390	3/8" Drive 6 Point Deep Metric Socket 8mm
80426	3/8" Drive Hex Bit Socket, 5mm	80126	1/4" Drive 6 Point Standard Metric Socket 5mm	80391	3/8" Drive 6 Point Deep Metric Socket 9mm
80427	3/8" Drive Hex Bit Socket, 6mm	80127	1/4" Drive 6 Point Standard Metric Socket 5.5mm	80392	3/8" Drive 6 Point Deep Metric Socket 10mm
80428D	3/8" Drive Hex Bit Socket, 7mm	80128	1/4" Drive 6 Point Standard Metric Socket 6mm	80393D	3/8" Drive 6 Point Deep Metric Socket 11mm
80429	3/8" Drive Hex Bit Socket, 8mm	80129	1/4" Drive 6 Point Standard Metric Socket 7mm	80394D	3/8" Drive 6 Point Deep Metric Socket 12mm
80430	3/8" Drive Hex Bit Socket, 9mm	80130	1/4" Drive 6 Point Standard Metric Socket 8mm	80395	3/8" Drive 6 Point Deep Metric Socket 13mm
80431	3/8" Drive Hex Bit Socket, 10mm	80131D	1/4" Drive 6 Point Standard Metric Socket 9mm	80396	3/8" Drive 6 Point Deep Metric Socket 14mm
80451	3/8" Drive TORX® Press-Fit Bit Socket, T-40	80132	1/4" Drive 6 Point Standard Metric Socket 10mm	80397	3/8" Drive 6 Point Deep Metric Socket 15mm
80452	3/8" Drive TORX® Press-Fit Bit Socket, T-45	80133	1/4" Drive 6 Point Standard Metric Socket 11mm	80398	3/8" Drive 6 Point Deep Metric Socket 16mm
80453	3/8" Drive TORX® Press-Fit Bit Socket, T-47	80134	1/4" Drive 6 Point Standard Metric Socket 12mm	80399	3/8" Drive 6 Point Deep Metric Socket 17mm
80454	3/8" Drive TORX® Press-Fit Bit Socket, T-50	80135D	1/4" Drive 6 Point Standard Metric Socket 13mm	80400	3/8" Drive 6 Point Deep Metric Socket 18mm
80455	3/8" Drive TORX® Press-Fit Bit Socket, T-55	80136	1/4" Drive 6 Point Standard Metric Socket 14mm	80401	3/8" Drive 6 Point Deep Metric Socket 19mm
81307	1/2" Drive Full Polish Flex Handle 15"	80137	1/4" Drive 6 Point Standard Metric Socket 15mm	80460	3/8" Drive External TORX® Socket, E-10
81113D	1/4" Drive Standard Extension 3"	80138	1/4" Drive 6 Point Deep Metric Socket 4mm	80461	3/8" Drive External TORX® Socket, E-12
81241	3/8" Drive Standard Extension 3"	80139	1/4" Drive 6 Point Deep Metric Socket 5mm	80462	3/8" Drive External TORX® Socket, E-14
81242	3/8" Drive Standard Extension 6"	80140	1/4" Drive 6 Point Deep Metric Socket 5.5mm	80463	3/8" Drive External TORX® Socket, E-16
81341	1/2" Drive Standard Extension 5"	80141	1/4" Drive 6 Point Deep Metric Socket 6mm	80603	1/2" Drive 6 Point Standard SAE Socket 1/2"
81650	1/4" Long Pattern Combination Wrench	80142	1/4" Drive 6 Point Deep Metric Socket 7mm	80604	1/2" Drive 6 Point Standard SAE Socket 9/16"
81651D	9/32" Long Pattern Combination Wrench	80143	1/4" Drive 6 Point Deep Metric Socket 8mm	80605	1/2" Drive 6 Point Standard SAE Socket 5/8"
81652D	5/16" Long Pattern Combination Wrench	80144	1/4" Drive 6 Point Deep Metric Socket 9mm	80606	1/2" Drive 6 Point Standard SAE Socket 11/16"
81653	11/32" Long Pattern Combination Wrench	80145	1/4" Drive 6 Point Deep Metric Socket 10mm	80607D	1/2" Drive 6 Point Standard SAE Socket 3/4"
81654	3/8" Long Pattern Combination Wrench	80146D	1/4" Drive 6 Point Deep Metric Socket 11mm	80608	1/2" Drive 6 Point Standard SAE Socket 13/16"
81655	7/16" Long Pattern Combination Wrench	80147	1/4" Drive 6 Point Deep Metric Socket 12mm	80609	1/2" Drive 6 Point Standard SAE Socket 7/8"
81656	1/2" Long Pattern Combination Wrench	80148	1/4" Drive 6 Point Deep Metric Socket 13mm	80610D	1/2" Drive 6 Point Standard SAE Socket 15/16"
81657	9/16" Long Pattern Combination Wrench	80149	1/4" Drive 6 Point Deep Metric Socket 14mm	80611	1/2" Drive 6 Point Standard SAE Socket 1"
81658	5/8" Long Pattern Combination Wrench	80150	1/4" Drive 6 Point Deep Metric Socket 15mm	80612	1/2" Drive 6 Point Standard SAE Socket 1-1/16"
81659	11/16" Long Pattern Combination Wrench	80187	1/4" Drive External TORX® Sockets, E-5	80613	1/2" Drive 6 Point Standard SAE Socket 1-1/8"
81660	3/4" Long Pattern Combination Wrench	80188D	1/4" Drive External TORX® Sockets, E-6	80624	1/2" Drive 6 Point Standard Metric Socket 12mm
81661	13/16" Long Pattern Combination Wrench	80189	1/4" Drive External TORX® Sockets, E-7	80625	1/2" Drive 6 Point Standard Metric Socket 13mm
81662	7/8" Long Pattern Combination Wrench	80190	1/4" Drive External TORX® Sockets, E-8	80626D	1/2" Drive 6 Point Standard Metric Socket 14mm
81663	15/16" Long Pattern Combination Wrench	80350	3/8" Drive 6 Point Standard SAE Socket 1/4"	80627	1/2" Drive 6 Point Standard Metric Socket 15mm
81664	1" Long Pattern Combination Wrench	80351	3/8" Drive 6 Point Standard SAE Socket 5/16"	80628	1/2" Drive 6 Point Standard Metric Socket 16mm
81665	8mm Long Pattern Combination Wrench	80352	3/8" Drive 6 Point Standard SAE Socket 3/8"	80629	1/2" Drive 6 Point Standard Metric Socket 17mm
81666	9mm Long Pattern Combination Wrench	80353	3/8" Drive 6 Point Standard SAE Socket 7/16"	80630	1/2" Drive 6 Point Standard Metric Socket 18mm
81667	10mm Long Pattern Combination Wrench	80354	3/8" Drive 6 Point Standard SAE Socket 1/2"	80631	1/2" Drive 6 Point Standard Metric Socket 19mm
81668	11mm Long Pattern Combination Wrench	80355	3/8" Drive 6 Point Standard SAE Socket 9/16"	80632	1/2" Drive 6 Point Standard Metric Socket 20mm
81669	12mm Long Pattern Combination Wrench	80356	3/8" Drive 6 Point Standard SAE Socket 5/8"	80633	1/2" Drive 6 Point Standard Metric Socket 21mm
81670	13mm Long Pattern Combination Wrench	80357	3/8" Drive 6 Point Standard SAE Socket 11/16"	80634	1/2" Drive 6 Point Standard Metric Socket 22mm
81671	14mm Long Pattern Combination Wrench	80358	3/8" Drive 6 Point Standard SAE Socket 3/4"	80635	1/2" Drive 6 Point Standard Metric Socket 23mm
81672	15mm Long Pattern Combination Wrench	80359	3/8" Drive 6 Point Standard SAE Socket 13/16"	80636D	1/2" Drive 6 Point Standard Metric Socket 24mm
81673	16mm Long Pattern Combination Wrench	80360	3/8" Drive 6 Point Standard SAE Socket 7/8"	80669D	1/2" Drive External Torx® Socket, E-18
81674	17mm Long Pattern Combination Wrench	80361	3/8" Drive 6 Point Standard SAE Socket 15/16"	80402	3/8" Drive Spark Plug Socket 5/8"
81675	18mm Long Pattern Combination Wrench	80362	3/8" Drive 6 Point Standard SAE Socket 1"	80403	3/8" Drive Spark Plug Socket 13/16"
81676	19mm Long Pattern Combination Wrench	80363	3/8" Drive 6 Point Deep SAE Socket 1/4"	80100	1/4" Drive Universal Joint
81677	20mm Long Pattern Combination Wrench	80364	3/8" Drive 6 Point Deep SAE Socket 5/16"	80549	3/8" Drive Universal Joint
81678	21mm Long Pattern Combination Wrench	80365	3/8" Drive 6 Point Deep SAE Socket 3/8"	80600D	1/2" Drive Universal Joint

GEARWRENCH® Intermediate Diesel TEP Set

- 84-Tooth 1/4", 3/8" and 1/2" Drive Ratchets
- Extensions – 1/4", 3/8" and 1/2" Drive
- Universal Joints – 1/4", 3/8" and 1/2" Drive
- Sockets – 1/4" Drive SAE and Metric, 3/8" Drive and 1/2" Drive in Standard and Deep, SAE and Metric
- Wrenches – Long Pattern Combination in SAE and Metric Sizes
- Screwdrivers – 12 Pc. Set, Torx® Bit Sockets – 13 Pc. Set
- Pliers – 4 Pc. Set and Double-X, Punches and Chisels – 12 Pc. set
- ALLEN® Hex Key Set – 13 Pc. SAE, 9 Pc. Metric
- General Purpose Tools – Extendable Pry Bar, Hacksaw, Hammers, Utility Knife, Flashlight, Locking Pliers, Safety Glasses, Tape Measure
- Automotive Specialty Tools – Low Voltage Circuit Tester, Feeler Gauge Gasket Scraper, Inspection Tools, Wire Stripper/Crimper and More



Cat. No.	UPC No.	Description
83096*	099575830969	Intermediate Diesel TEP Set

* Please Note: Most tools GearWrench branded. May include other leading Apex Tool Group brands.

Cat. No.	Description	Cat. No.	Description	Cat. No.	Description
129D	Low-Voltage Circuit Tester	82012	7" Diagonal Cutting Pliers	82261	1/4" x 4-3/4" x 1/4" Cold Chisel
162D	Feeler Gauge	82013	8" Long Nose Pliers	82262	3/8" x 5" x 5/16" Cold Chisel
2162D	Electrical Wire Stripper and Crimper	82014	8" Slip Joint Pliers	82264	1/2" x 6" x 3/8" Cold Chisel
2593	Pocket Telescoping Magnetic Pickup Tool	82220	29" Extendable Indexing Pry Bar	82265	5/8" x 6-1/2" x 3/8" Cold Chisel
2840D	1-1/4" Round Magnifying Mirror with Pocket Clip	82251	16 oz Ball Pein Hammer - Fiberglass	82270	3/8" x 5" Center Punch
80965	12" Cushion Grip High Tension Hacksaw Frame	82255	3 lb Drilling Hammer	82272	3/32" x 4-3/4" x 5/16" Pin Punch
82005D	Straight Double-X™ Pliers	82259	16 oz Rubber Mallet - Wood Hickory Handle	82273	1/8" x 5" x 5/16" Pin Punch
82011	9-1/2" Tongue and Groove Pliers	82260	12 oz Soft Face Hammer, Removable Caps	82274	5/32" x 5-1/4" x 5/16" Pin Punch

Contents continued on next page.



Cat. No.	Description	Cat. No.	Description	Cat. No.	Description
82275	3/16" x 5-1/2" x 5/16" Pin Punch	81671	14mm Long Pattern Combination Wrench	80380	3/8" Drive 6 Point Standard Metric Socket 12mm
82278	1/8" x 8" x 3/8" Long Taper Punch	81672	15mm Long Pattern Combination Wrench	80381	3/8" Drive 6 Point Standard Metric Socket 13mm
82283	3/16" x 5" x 3/8" Starter Punch	81673	16mm Long Pattern Combination Wrench	80382	3/8" Drive 6 Point Standard Metric Socket 14mm
82285	1/8" x 4-1/2" x 5/16" Starter	81674	17mm Long Pattern Combination Wrench	80383	3/8" Drive 6 Point Standard Metric Socket 15mm
82881	Folding Utility Knife	81675	18mm Long Pattern Combination Wrench	80384	3/8" Drive 6 Point Standard Metric Socket 16mm
83132	LED Flashlight with Carry Case	81676	19mm Long Pattern Combination Wrench	80385	3/8" Drive 6 Point Standard Metric Socket 17mm
84083	1" Wide Scraper Long	81677	20mm Long Pattern Combination Wrench	80386	3/8" Drive 6 Point Standard Metric Socket 18mm
C10CV	10" Curved Jaw Locking Plier With Wire Cutter	81678	21mm Long Pattern Combination Wrench	80387	3/8" Drive 6 Point Standard Metric Socket 19mm
C5CV	5" Curved Jaw Locking Plier With Wire Cutter	81679	22mm Long Pattern Combination Wrench	80388	3/8" Drive 6 Point Deep Metric Socket 6mm
C6NV	6" Long Nose Locking Plier With Wire Cutter	81741	23mm Long Pattern Combination Wrench	80389	3/8" Drive 6 Point Deep Metric Socket 7mm
-	Safety Glasses	81742	24mm Long Pattern Combination Wrench	80390	3/8" Drive 6 Point Deep Metric Socket 8mm
PS3316	3/4" x 16' Pro Series 3000 Power Return Tape	81743	27mm Long Pattern Combination Wrench	80391	3/8" Drive 6 Point Deep Metric Socket 9mm
2283	Phillips Screw Starter	81744	30mm Long Pattern Combination Wrench	80392	3/8" Drive 6 Point Deep Metric Socket 10mm
80000	Dual Material Phillips® Screwdriver #0 x 2-1/2"	81745D	32mm Long Pattern Combination Wrench	80393D	3/8" Drive 6 Point Deep Metric Socket 11mm
80001	Dual Material Phillips® Screwdriver #1 x 3"	81011F	1/4" Drive Full Polish Teardrop Ratchet	80394D	3/8" Drive 6 Point Deep Metric Socket 12mm
80004	Dual Material Phillips® Screwdriver #1 x 6"	81211F	3/8" Drive Full Polish Teardrop Ratchet	80395	3/8" Drive 6 Point Deep Metric Socket 13mm
80005	Dual Material Phillips® Screwdriver #2 x 1-1/2"	81304F	1/2" Drive Full Polish Teardrop Ratchet	80396	3/8" Drive 6 Point Deep Metric Socket 14mm
80007	Dual Material Phillips® Screwdriver #2 x 4"	80105	1/4" Drive 6 Point Standard SAE Socket 3/16"	80397	3/8" Drive 6 Point Deep Metric Socket 15mm
80011	Dual Material Phillips® Screwdriver #3 x 6"	80106	1/4" Drive 6 Point Standard SAE Socket 7/32"	80398	3/8" Drive 6 Point Deep Metric Socket 16mm
2282D	Slotted Screw Starter	80107	1/4" Drive 6 Point Standard SAE Socket 1/4"	80399	3/8" Drive 6 Point Deep Metric Socket 17mm
80012D	Dual Material Slotted Screwdriver 1/4 x 1-1/2"	80108	1/4" Drive 6 Point Standard SAE Socket 9/32"	80400	3/8" Drive 6 Point Deep Metric Socket 18mm
80013	Dual Material Slotted Screwdriver 1/4 x 4"	80109	1/4" Drive 6 Point Standard SAE Socket 5/16"	80401	3/8" Drive 6 Point Deep Metric Socket 19mm
80014	Dual Material Slotted Screwdriver 1/4 x 6"	80110	1/4" Drive 6 Point Standard SAE Socket 11/32"	80603	1/2" Drive 6 Point Standard SAE Socket 1/2"
80018D	Dual Material Slotted Screwdriver 3/16 x 6"	80111	1/4" Drive 6 Point Standard SAE Socket 3/8"	80604	1/2" Drive 6 Point Standard SAE Socket 9/16"
80022	Dual Material Slotted Screwdriver 3/8 x 8"	80112	1/4" Drive 6 Point Standard SAE Socket 7/16"	80605	1/2" Drive 6 Point Standard SAE Socket 5/8"
80023	Dual Material Slotted Screwdriver 5/16 x 6"	80113D	1/4" Drive 6 Point Standard SAE Socket 1/2"	80606	1/2" Drive 6 Point Standard SAE Socket 11/16"
56615G	9 Piece Long Arm Metric Ball-Plus™ Hex Key Set	80114D	1/4" Drive 6 Point Standard SAE Socket 9/16"	80607D	1/2" Drive 6 Point Standard SAE Socket 3/4"
56603G	13 Piece Long Arm SAE Hex Key Set	80125	1/4" Drive 6 Point Standard Metric Socket 4mm	80608	1/2" Drive 6 Point Standard SAE Socket 13/16"
81128	1/4" Socket Driver	80126	1/4" Drive 6 Point Standard Metric Socket 5mm	80609	1/2" Drive 6 Point Standard SAE Socket 7/8"
80172	1/4" Drive TORX® Press Fit Bit Socket, T-10	80127	1/4" Drive 6 Point Standard Metric Socket 5.5mm	80610D	1/2" Drive 6 Point Standard SAE Socket 15/16"
80173	1/4" Drive TORX® Press Fit Bit Socket, T-15	80128	1/4" Drive 6 Point Standard Metric Socket 6mm	80611	1/2" Drive 6 Point Standard SAE Socket 1"
80174	1/4" Drive TORX® Press Fit Bit Socket, T-20	80129	1/4" Drive 6 Point Standard Metric Socket 7mm	80612	1/2" Drive 6 Point Standard SAE Socket 1-1/16"
80175	1/4" Drive TORX® Press Fit Bit Socket, T-25	80130	1/4" Drive 6 Point Standard Metric Socket 8mm	80613	1/2" Drive 6 Point Standard SAE Socket 1-1/8"
80176D	1/4" Drive TORX® Press Fit Bit Socket, T-27	80131D	1/4" Drive 6 Point Standard Metric Socket 9mm	80614	1/2" Drive 6 Point Deep SAE Socket 1/2"
80177D	1/4" Drive TORX® Press Fit Bit Socket, T-30	80132	1/4" Drive 6 Point Standard Metric Socket 10mm	80615	1/2" Drive 6 Point Deep SAE Socket 9/16"
80171	1/4" Drive TORX® Press Fit Bit Socket, T-8	80133	1/4" Drive 6 Point Standard Metric Socket 11mm	80616	1/2" Drive 6 Point Deep SAE Socket 5/8"
80451	3/8" Drive TORX® Press-Fit Bit Socket, T-40	80134	1/4" Drive 6 Point Standard Metric Socket 12mm	80617	1/2" Drive 6 Point Deep SAE Socket 11/16"
80452	3/8" Drive TORX® Press-Fit Bit Socket, T-45	80135D	1/4" Drive 6 Point Standard Metric Socket 13mm	80618	1/2" Drive 6 Point Deep SAE Socket 3/4"
80453	3/8" Drive TORX® Press-Fit Bit Socket, T-47	80136	1/4" Drive 6 Point Standard Metric Socket 14mm	80619	1/2" Drive 6 Point Deep SAE Socket 13/16"
80454	3/8" Drive TORX® Press-Fit Bit Socket, T-50	80137	1/4" Drive 6 Point Standard Metric Socket 15mm	80620	1/2" Drive 6 Point Deep SAE Socket 7/8"
80455	3/8" Drive TORX® Press-Fit Bit Socket, T-55	80350	3/8" Drive 6 Point Standard SAE Socket 1/4"	80621	1/2" Drive 6 Point Deep SAE Socket 15/16"
80667	1/2" Drive TORX® Press Fit Bit Socket, T-60	80351	3/8" Drive 6 Point Standard SAE Socket 5/16"	80624	1/2" Drive 6 Point Standard Metric Socket 12mm
81307	1/2" Drive Full Polish Flex Handle 15"	80352	3/8" Drive 6 Point Standard SAE Socket 3/8"	80625	1/2" Drive 6 Point Standard Metric Socket 13mm
81113D	1/4" Drive Standard Extension 3"	80353	3/8" Drive 6 Point Standard SAE Socket 7/16"	80626D	1/2" Drive 6 Point Standard Metric Socket 14mm
81241	3/8" Drive Standard Extension 3"	80354	3/8" Drive 6 Point Standard SAE Socket 1/2"	80627	1/2" Drive 6 Point Standard Metric Socket 15mm
81242	3/8" Drive Standard Extension 6"	80355	3/8" Drive 6 Point Standard SAE Socket 9/16"	80628	1/2" Drive 6 Point Standard Metric Socket 16mm
81341	1/2" Drive Standard Extension 5"	80356	3/8" Drive 6 Point Standard SAE Socket 5/8"	80629	1/2" Drive 6 Point Standard Metric Socket 17mm
81342	1/2" Drive Standard Extension 10"	80357	3/8" Drive 6 Point Standard SAE Socket 11/16"	80630	1/2" Drive 6 Point Standard Metric Socket 18mm
81650	1/4" Long Pattern Combination Wrench	80358	3/8" Drive 6 Point Standard SAE Socket 3/4"	80631	1/2" Drive 6 Point Standard Metric Socket 19mm
81651D	9/32" Long Pattern Combination Wrench	80359	3/8" Drive 6 Point Standard SAE Socket 13/16"	80632	1/2" Drive 6 Point Standard Metric Socket 20mm
81652D	5/16" Long Pattern Combination Wrench	80360	3/8" Drive 6 Point Standard SAE Socket 7/8"	80633	1/2" Drive 6 Point Standard Metric Socket 21mm
81653	11/32" Long Pattern Combination Wrench	80361	3/8" Drive 6 Point Standard SAE Socket 15/16"	80634	1/2" Drive 6 Point Standard Metric Socket 22mm
81654	3/8" Long Pattern Combination Wrench	80362	3/8" Drive 6 Point Standard SAE Socket 1"	80635	1/2" Drive 6 Point Standard Metric Socket 23mm
81655	7/16" Long Pattern Combination Wrench	80363	3/8" Drive 6 Point Deep SAE Socket 1/4"	80636D	1/2" Drive 6 Point Standard Metric Socket 24mm
81656	1/2" Long Pattern Combination Wrench	80364	3/8" Drive 6 Point Deep SAE Socket 5/16"	80637	1/2" Drive 6 Point Deep Metric Socket 10mm
81657	9/16" Long Pattern Combination Wrench	80365	3/8" Drive 6 Point Deep SAE Socket 3/8"	80638	1/2" Drive 6 Point Deep Metric Socket 11mm
81658	5/8" Long Pattern Combination Wrench	80366	3/8" Drive 6 Point Deep SAE Socket 7/16"	80639	1/2" Drive 6 Point Deep Metric Socket 12mm
81659	11/16" Long Pattern Combination Wrench	80367	3/8" Drive 6 Point Deep SAE Socket 1/2"	80640	1/2" Drive 6 Point Deep Metric Socket 13mm
81660	3/4" Long Pattern Combination Wrench	80368	3/8" Drive 6 Point Deep SAE Socket 9/16"	80641	1/2" Drive 6 Point Deep Metric Socket 14mm
81661	13/16" Long Pattern Combination Wrench	80369	3/8" Drive 6 Point Deep SAE Socket 5/8"	80642	1/2" Drive 6 Point Deep Metric Socket 15mm
81662	7/8" Long Pattern Combination Wrench	80370D	3/8" Drive 6 Point Deep SAE Socket 11/16"	80643	1/2" Drive 6 Point Deep Metric Socket 16mm
81663	15/16" Long Pattern Combination Wrench	80371	3/8" Drive 6 Point Standard SAE Socket 3/4"	80644	1/2" Drive 6 Point Deep Metric Socket 17mm
81736	6mm Long Pattern Combination Wrench	80372	3/8" Drive 6 Point Deep SAE Socket 13/16"	80645	1/2" Drive 6 Point Deep Metric Socket 18mm
81737	7mm Long Pattern Combination Wrench	80373	3/8" Drive 6 Point Deep SAE Socket 7/8"	80646D	1/2" Drive 6 Point Deep Metric Socket 19mm
81665	8mm Long Pattern Combination Wrench	80374	3/8" Drive 6 Point Standard Metric Socket 6mm	80402	3/8" Drive Spark Plug Socket 5/8"
81666	9mm Long Pattern Combination Wrench	80375	3/8" Drive 6 Point Standard Metric Socket 7mm	80403	3/8" Drive Spark Plug Socket 13/16"
81667	10mm Long Pattern Combination Wrench	80376	3/8" Drive 6 Point Standard Metric Socket 8mm	80100	1/4" Drive Universal Joint
81668	11mm Long Pattern Combination Wrench	80377	3/8" Drive 6 Point Standard Metric Socket 9mm	80549	3/8" Drive Universal Joint
81669	12mm Long Pattern Combination Wrench	80378	3/8" Drive 6 Point Standard Metric Socket 10mm	80600D	1/2" Drive Universal Joint
81670	13mm Long Pattern Combination Wrench	80379	3/8" Drive 6 Point Standard Metric Socket 11mm		

GEARWRENCH® Aviation Introductory TEP Set

- 84-Tooth 1/4" and 3/8" Drive Ratchets, 3/8" Drive Speeder Handle
- Extensions – 1/4" and 3/8" Drive
- Universal Joints – 1/4" and 3/8" Drive
- Sockets – 1/4" and 3/8" Drive Standard and Deep, SAE Sizes
- Wrenches – Long Pattern Combination in SAE Sizes
- Screwdrivers – 6 Pc. Set
- Pliers – 4 Pc. Set
- General Purpose Tools – Hammers, Utility Knife, Flashlight, Locking Pliers, Ear Muffs, Safety Glasses, Tool Box with Tote
- Specialty Tools – Flexible Pickup Tool, Inspection Tools, Wire Stripper/Crimper, Scraper, and More



Cat. No.	UPC No.	Description
83080*	099575830808	Aviation Introductory TEP Set

* Please Note: Most tools GearWrench branded. May include other leading Apex Tool Group brands.

Cat. No.	Description	Cat. No.	Description	Cat. No.	Description
2162D	Electrical Wire Stripper and Crimper	81654	3/8" Long Pattern Combination Wrench	80227	1/4" Drive 12 Point Deep Socket 7/16"
2282D	Slotted Screw Starter	81655	7/16" Long Pattern Combination Wrench	80228	1/4" Drive 12 Point Deep Socket 1/2"
2283	Phillips Screw Starter	81656	1/2" Long Pattern Combination Wrench	80229	1/4" Drive 12 Point Deep Socket 9/16"
2391	Flexible Retrieving Tool	81657	9/16" Long Pattern Combination Wrench	80496	3/8" Drive 12 Point Standard SAE Socket 1/4"
2425D	1-1/4" Scraper	81658	5/8" Long Pattern Combination Wrench	80497D	3/8" Drive 12 Point Standard SAE Socket 5/16"
2593	Pocket Telescoping Magnetic Pickup Tool	81659	11/16" Long Pattern Combination Wrench	80498	3/8" Drive 12 Point Standard SAE Socket 3/8"
2840D	1-1/4" Round Magnifying Mirror with Pocket Clip	81660	3/4" Long Pattern Combination Wrench	80499	3/8" Drive 12 Point Standard SAE Socket 7/16"
2979	Scriber	81661	13/16" Long Pattern Combination Wrench	80500D	3/8" Drive 12 Point Standard SAE Socket 1/2"
80001	Dual Material Phillips® Screwdriver #1 x 3"	81662	7/8" Long Pattern Combination Wrench	80501	3/8" Drive 12 Point Standard SAE Socket 9/16"
80007	Dual Material Phillips® Screwdriver #2 x 4"	81663	15/16" Long Pattern Combination Wrench	80502	3/8" Drive 12 Point Standard SAE Socket 5/8"
80013	Dual Material Slotted Screwdriver 1/4 x 4"	81664	1" Long Pattern Combination Wrench	80503	3/8" Drive 12 Point Standard SAE Socket 11/16"
80015	Dual Material Slotted Screwdriver 1/8 x 3"	81011F	1/4" Drive Full Polish Teardrop Ratchet	80504	3/8" Drive 12 Point Standard SAE Socket 3/4"
80022	Dual Material Slotted Screwdriver 3/8 x 8"	81211F	3/8" Drive Full Polish Teardrop Ratchet	80505	3/8" Drive 12 Point Standard SAE Socket 13/16"
80023	Dual Material Slotted Screwdriver 5/16 x 6"	80210	1/4" Drive 12 Point Standard SAE Socket 3/16"	80506D	3/8" Drive 12 Point Standard SAE Socket 7/8"
82011	9-1/2" Tongue and Groove Pliers	80211	1/4" Drive 12 Point Standard SAE Socket 7/32"	80507	3/8" Drive 12 Point Standard SAE Socket 15/16"
82012	7" Diagonal Cutting Pliers	80212	1/4" Drive 12 Point Standard SAE Socket 1/4"	80508	3/8" Drive 12 Point Standard SAE Socket 1"
82013	8" Long Nose Pliers	80213	1/4" Drive 12 Point Standard SAE Socket 9/32"	80509	3/8 Drive 12 Point Deep SAE Socket 1/4"
82014	8" Slip Joint Pliers	80214	1/4" Drive 12 Point Standard SAE Socket 5/16"	80510D	3/8 Drive 12 Point Deep SAE Socket 5/16"
83130	19" Steel Tote Box - Black	80215D	1/4" Drive 12 Point Standard SAE Socket 11/32"	80511	3/8 Drive 12 Point Deep SAE Socket 3/8"
-	Ear Muffs	80216	1/4" Drive 12 Point Standard SAE Socket 3/8"	80512	3/8 Drive 12 Point Deep SAE Socket 7/16"
-	Safety Glasses	80217	1/4" Drive 12 Point Standard SAE Socket 7/16"	80513	3/8 Drive 12 Point Deep SAE Socket 1/2"
81128	1/4" Socket Driver	80218	1/4" Drive 12 Point Standard SAE Socket 1/2"	80514	3/8 Drive 12 Point Deep SAE Socket 9/16"
11-935	3/8" Drive Speeder Handle with Polished Handle	80219	1/4" Drive 12 Point Standard SAE Socket 9/16"	80515D	3/8 Drive 12 Point Deep SAE Socket 5/8"
81113D	1/4" Drive Standard Extension 3"	80220	1/4" Drive 12 Point Deep Socket 3/16"	80516	3/8 Drive 12 Point Deep SAE Socket 11/16"
81116	1/4" Drive Standard Extension 6"	80221	1/4" Drive 12 Point Deep Socket 7/32"	80517	3/8 Drive 12 Point Deep SAE Socket 3/4"
81242	3/8" Drive Standard Extension 6"	80222	1/4" Drive 12 Point Deep Socket 1/4"	80518	3/8 Drive 12 Point Deep SAE Socket 13/16"
81650	1/4" Long Pattern Combination Wrench	80223D	1/4" Drive 12 Point Deep Socket 9/32"	80519	3/8 Drive 12 Point Deep SAE Socket 7/8"
81651D	9/32" Long Pattern Combination Wrench	80224	1/4" Drive 12 Point Deep Socket 5/16"	80100	1/4" Drive Universal Joint
81652D	5/16" Long Pattern Combination Wrench	80225	1/4" Drive 12 Point Deep Socket 11/32"	80549	3/8" Drive Universal Joint
81653	11/32" Long Pattern Combination Wrench	80226	1/4" Drive 12 Point Deep Socket 3/8"		

GEARWRENCH® Intermediate Aviation TEP Set

- 84-Tooth 1/4" and 3/8" Drive Ratchets, 3/8" Drive Speeder Handle
- Extensions – 1/4" and 3/8" Drive
- Universal Joints – 1/4" and 3/8" Drive
- Sockets – 1/4" and 3/8" Drive Standard and Deep, SAE Sizes, 1/4" Drive Flex Sockets
- Wrenches – Long Pattern Combination in SAE Sizes
- ALLEN® Hex Key Set – 13 Pc. SAE
- Pliers – 4 Pc. Set, Files – 4 Pc. Set and 6 Pc. Mini Set
- Wiss® Snips – 3 Pc. Set
- General Purpose Tools – Adjustable Wrenches, Hacksaw, Hammers, Utility Knife, Tape Measure, Flashlight, Locking Pliers, Ear Muffs, Safety Glasses
- Specialty Tools – Flexible Pick-up Tool, Inspection Tools, Wire Stripper/Crimper, Snap Ring Pliers, Feeler Gauge, Screw Starters, and More



Cat. No.	UPC No.	Description
83098*	099575830983	Intermediate Aviation TEP Set

* Please Note: Most tools GearWrench branded. May include other leading Apex Tool Group brands.

Cat. No.	Description	Cat. No.	Description	Cat. No.	Description
162D	Feeler Gauge	PS3316	3/4" x 16" Pro Series 3000 Power Return Tape	80221	1/4" Drive 12 Point Deep Socket 7/32"
2162D	Electrical Wire Stripper and Crimper	2283	Phillips Screw Starter	80222	1/4" Drive 12 Point Deep Socket 1/4"
2309D	Stainless Steel Brush	80001	Dual Material Phillips® Screwdriver #1 x 3"	80223D	1/4" Drive 12 Point Deep Socket 9/32"
2391	Flexible Retrieving Tool	80007	Dual Material Phillips® Screwdriver #2 x 4"	80224	1/4" Drive 12 Point Deep Socket 5/16"
2425D	1-1/4" Scraper	2282D	Slotted Screw Starter	80225	1/4" Drive 12 Point Deep Socket 11/32"
2593	Pocket Telescoping Magnetic Pickup Tool	80013	Dual Material Slotted Screwdriver 1/4 x 4"	80226	1/4" Drive 12 Point Deep Socket 3/8"
2840D	1-1/4" Round Magnifying Mirror with Pocket Clip	80015	Dual Material Slotted Screwdriver 1/8 x 3"	80227	1/4" Drive 12 Point Deep Socket 7/16"
2979	Scriber	80022	Dual Material Slotted Screwdriver 3/8 x 8"	80228	1/4" Drive 12 Point Deep Socket 1/2"
3151	Universal Convertible Retaining Ring Pliers, Large	80023	Dual Material Slotted Screwdriver 5/16 x 6"	80229	1/4" Drive 12 Point Standard SAE Socket 1/2"
80965	12" Cushion Grip High Tension Hacksaw Frame	56612G	13 Piece Long Arm SAE Ball-Plus™ Hex Key Set	80496	3/8" Drive 12 Point Standard SAE Socket 1/4"
82011	9-1/2" Tongue and Groove Pliers	81128	1/4" Socket Driver	80497D	3/8" Drive 12 Point Standard SAE Socket 5/16"
82012	7" Diagonal Cutting Pliers	11-935	3/8" Drive Speeder Handle with Polished Handle	80498	3/8" Drive 12 Point Standard SAE Socket 3/8"
82013	8" Long Nose Pliers	81891	8" Adjustable Wrench with Cushion Grip	80499	3/8" Drive 12 Point Standard SAE Socket 7/16"
82014	8" Slip Joint Pliers	81893	12" Adjustable Wrench with Cushion Grip	80500D	3/8" Drive 12 Point Standard SAE Socket 13/16"
82251	16 oz Ball Pein Hammer - Fiberglass	81113D	1/4" Drive Standard Extension 3"	80501	3/8" Drive 12 Point Standard SAE Socket 9/16"
82260	12 oz Soft Face Hammer, Removable Caps	81116	1/4" Drive Standard Extension 6"	80502	3/8" Drive 12 Point Standard SAE Socket 5/8"
82261	1/4" x 4-3/4" x 1/4" Cold Chisel	81241	3/8" Drive Standard Extension 3"	80503	3/8" Drive 12 Point Standard SAE Socket 11/16"
82262	3/8" x 5" x 5/16" Cold Chisel	81242	3/8" Drive Standard Extension 6"	80504	3/8" Drive 12 Point Standard SAE Socket 3/4"
82264	1/2" x 6" x 3/8" Cold Chisel	81650	1/4" Long Pattern Combination Wrench	80505	3/8" Drive 12 Point Standard SAE Socket 13/16"
82265	5/8" x 6-1/2" x 3/8" Cold Chisel	81651D	9/32" Long Pattern Combination Wrench	80506D	3/8" Drive 12 Point Standard SAE Socket 7/8"
82270	3/8" x 5" Center Punch	81652D	5/16" Long Pattern Combination Wrench	80507	3/8" Drive 12 Point Standard SAE Socket 15/16"
82272	3/32" x 4-3/4" x 5/16" Pin Punch	81653	11/32" Long Pattern Combination Wrench	80508	3/8" Drive 12 Point Standard SAE Socket 1"
82273	1/8" x 5" x 5/16" Pin Punch	81654	3/8" Long Pattern Combination Wrench	80509	3/8 Drive 12 Point Deep SAE Socket 1/4"
82274	5/32" x 5-1/4" x 5/16" Pin Punch	81655	7/16" Long Pattern Combination Wrench	80510D	3/8 Drive 12 Point Deep SAE Socket 5/16"
82275	3/16" x 5-1/2" x 5/16" Pin Punch	81656	1/2" Long Pattern Combination Wrench	80511	3/8 Drive 12 Point Deep SAE Socket 3/8"
82278	1/8" x 8" x 3/8" Long Taper Punch	81657	9/16" Long Pattern Combination Wrench	80512	3/8 Drive 12 Point Deep SAE Socket 7/16"
82283	3/16" x 5" x 3/8" Starter Punch	81658	5/8" Long Pattern Combination Wrench	80513	3/8 Drive 12 Point Deep SAE Socket 1/2"
82285	1/8" x 4-1/2" x 5/16" Starter	81659	11/16" Long Pattern Combination Wrench	80514	3/8 Drive 12 Point Deep SAE Socket 9/16"
82822D	8" Flat Bastard File	81660	3/4" Long Pattern Combination Wrench	80515D	3/8 Drive 12 Point Deep SAE Socket 5/8"
82823	8" Round Bastard File	81661	13/16" Long Pattern Combination Wrench	80516	3/8 Drive 12 Point Deep SAE Socket 11/16"
82824	8" Half Round Bastard File	81662	7/8" Long Pattern Combination Wrench	80517	3/8 Drive 12 Point Deep SAE Socket 3/4"
82825	8" Triangle Bastard File	81663	15/16" Long Pattern Combination Wrench	80518	3/8 Drive 12 Point Deep SAE Socket 13/16"
82881	Folding Utility Knife	81664	1" Long Pattern Combination Wrench	80519	3/8 Drive 12 Point Deep SAE Socket 7/8"
83132	LED Flashlight with Carry Case	81011F	1/4" Drive Full Polish Teardrop Ratchet	80402	3/8" Drive Spark Plug Socket 5/8"
C5CV	5" Curved Jaw Locking Plier With Wire Cutter	81211F	3/8" Drive Full Polish Teardrop Ratchet	80403	3/8" Drive Spark Plug Socket 13/16"
M1R	9-3/4" Compound Action Snips, Cuts Straight to Left	80210	1/4" Drive 12 Point Standard SAE Socket 3/16"	80100	1/4" Drive Universal Joint
M2R	9-3/4" Compound Action Snips, Cuts Straight to Right	80211	1/4" Drive 12 Point Standard SAE Socket 7/32"	80549	3/8" Drive Universal Joint
M3R	9-3/4" Compound Action Snips, Straight, Left, Right	80212	1/4" Drive 12 Point Standard SAE Socket 1/4"	80262	1/4" Drive 6 Point Flex Socket 3/16"
-	4" Flat Mini File	80213	1/4" Drive 12 Point Standard SAE Socket 9/32"	80263D	1/4" Drive 6 Point Flex Socket 1/4"
-	4" Half Round Mini File	80214	1/4" Drive 12 Point Standard SAE Socket 5/16"	80264	1/4" Drive 6 Point Flex Socket 5/16"
-	4" Knife Mini File	80215D	1/4" Drive 12 Point Standard SAE Socket 11/32"	80265	1/4" Drive 6 Point Flex Socket 3/8"
-	4" Round Mini File	80216	1/4" Drive 12 Point Standard SAE Socket 3/8"	80266	1/4" Drive 6 Point Flex Socket 7/16"
-	4" Square Mini File	80217	1/4" Drive 12 Point Standard SAE Socket 7/16"	80267	1/4" Drive 6 Point Flex Socket 1/2"
-	4" Triangle Mini File	80218	1/4" Drive 12 Point Standard SAE Socket 1/2"	80268	1/4" Drive 6 Point Flex Socket 9/16"
-	Ear Muffs	80219	1/4" Drive 12 Point Standard SAE Socket 9/16"		
-	Safety Glasses	80220	1/4" Drive 12 Point Deep Socket 3/16"		

**YOU'RE GONNA NEED
A BIGGER BOX**





GEARWRENCH®

XL Series Roller Cabinets & Chests .	27
XL Tool Carts	29
TEP Series Roller Cabinets & Chests	30
Tool Boxes	33
Socket Rails and Clips	33
Magnetic Storage Trays	34

GEARWRENCH® Tool Storage

Professionals have come to expect innovation and increased productivity when using GearWrench® products; with the XL series you can continue to expect the same superior design and construction to make you more productive on the job. Choose XL when you need a tool storage system that stands up to your growing demands. Formed with rolled over drawer walls, heavy gauge steel bodies, and stamped drawer bottoms, the XL series provides the required strength, durability, and rigidity to withstand your professional demands.

GEARWRENCH XL SERIES TOOL STORAGE



Trigger Lock drawer system keeps drawers in place and opens with a natural pull operation

All drawers feature Auto Return, which snaps the drawers closed in the final inches of operation



Formed with rolled over drawer walls adding strength and rigidity



Double Ball-Bearing construction offers exceptional load capacity and easy slide action



A 9 mm top mat provides protection and support on all cabinets

Dual gas shocks on all lids offer support and easily controlled closure

High strength side lift handles are integrated into the box wall for added durability and lift capacity



Barrel style lock and key are unique combination for security and durability

Durable powder-coated full-polished lacquer coating protects against scratches and marring

One set of locking casters on all cabinets and carts

All drawers come with drawer liners

GEARWRENCH® 53" 9 Drawer Roller Cabinet, XL Series

- Trigger Lock Drawer System Keeps Drawers in Place
- Ball Bearing Drawer Slides with Auto Return
- Drawer Liners in All Drawers (Black Foam)
- Brushed Aluminum Handles and Drawer Pulls
- Barrel Style Lock
- Heavy-Duty Construction
- Top Mat 1/3" (9mm) Thick
- Set of Locking Casters
- High-Gloss Scratch Resistant Powder Coat Finish
- Cabinet Body, Middle, and Large Drawers Made from 20-ga Steel. Small Drawers Made from 22-ga Steel.



Drawer Description	Drawer Width	Drawer Depth	Drawer Height	Drawer Load Weight
Full Width - 1 Drawer	48.00 in	15.50 in	3.75 in	132 lb
Left - 1 Drawer	29.50 in	15.50 in	8.50 in	88 lb
Left - 1 Drawer	29.50 in	15.50 in	5.50 in	88 lb
Left - 2 Drawers	29.50 in	15.50 in	2.25 in	88 lb
Right - 1 Drawer	16.00 in	15.50 in	11.50 in	132 lb
Right - 3 Drawers	16.00 in	15.50 in	2.25 in	88 lb

Cat. No.	UPC No.	Color	Caster Size	Storage Volume	Width	Depth	Height	Load Weight	Drawer Slides	Product Weight
83158	099575831584	Black/Silver	5 in x 2 in	15,661 cubic in.	53.00 in	19.00 in	39.50 in	1760 lb	Ball Bearing	326.00 lb

GEARWRENCH® 42" 8 Drawer Chest, XL Series

- Trigger Lock Drawer System Keeps Drawers in Place
- Ball Bearing Drawer Slides with Auto Return
- Drawer Liners in All Drawers (Black Foam)
- Brushed Aluminum Handles and Drawer Pulls
- Barrel Style Lock
- Heavy-Duty Construction
- Top Storage for Quick Access to Tools and Supplies
- High-Gloss Scratch Resistant Powder Coat Finish
- Lift Handles on Side for Portability
- Chest Body Made from 20-ga Steel. Drawers Made from 22-ga Steel.



Drawer Description	Drawer Width	Drawer Depth	Drawer Height	Drawer Load Weight
Left - 4 Drawers	22.50 in	15.50 in	2.25 in	88 lb
Right - 4 Drawers	12.00 in	15.50 in	2.25 in	88 lb

Cat. No.	UPC No.	Color	Storage Volume	Width	Depth	Height	Drawer Slides	Top Storage	Handled	Product Weight
83156	099575831560	Black/Silver	7,814 cubic in.	41.00 in	18.25 in	20.50 in	Ball Bearing	Yes	Yes	167.50 lb

GEARWRENCH® 42" 11 Drawer Roller Cabinet, XL Series

- Trigger Lock Drawer System Keeps Drawers in Place
- Ball Bearing Drawer Slides with Auto Return
- Drawer Liners in All Drawers (Black Foam)
- Brushed Aluminum Handles and Drawer Pulls
- Barrel Style Lock
- Heavy-Duty Construction
- Top Mat 1/3" (9mm) Thick
- Set of Locking Casters
- High-Gloss Scratch Resistant Powder Coat Finish
- Cabinet Body, Middle and Large Drawers Made from 20-ga Steel. Small Drawers Made from 22-ga Steel.



Drawer Description	Drawer Width	Drawer Depth	Drawer Height	Drawer Load Weight
Full Width - 1 Drawer	36.75 in	15.50 in	3.75 in	132 lb
Left - 1 Drawer	22.75 in	15.50 in	5.50 in	88 lb
Left - 5 Drawers	22.75 in	15.50 in	2.25 in	88 lb
Right - 1 Drawer	12.25 in	15.50 in	11.75 in	132 lb
Right - 3 Drawers	12.25 in	15.50 in	2.25 in	88 lb

Cat. No.	UPC No.	Color	Caster Size	Storage Volume	Width	Depth	Height	Load Weight	Drawer Slides	Product Weight
83157	099575831577	Black/Silver	5 in x 2 in	12,320 cubic in.	42.00 in	19.00 in	39.00 in	1210 lb	Ball Bearing	301.80 lb

GEARWRENCH® 26" 4 Drawer Chest, XL Series

- Trigger Lock Drawer System Keeps Drawers in Place
- Ball Bearing Drawer Slides with Auto Return
- Drawer Liners in All Drawers (Black Foam)
- Brushed Aluminum Handles and Drawer Pulls
- Barrel Style Lock
- Heavy-Duty Construction
- Top Storage for Quick Access to Tools and Supplies
- High-Gloss Scratch Resistant Powder Coat Finish
- Lift Handles on Side for Portability. Removable Hand Tool Tray
- Chest Body Made from 20-ga Steel. Drawers Made from 22-ga Steel.



Drawer Description	Drawer Width	Drawer Depth	Drawer Height	Drawer Load Weight
Top Tray	17.00 in	6.75 in	1.75 in	20 lb
4 Drawers	25.75 in	17.50 in	2.75 in	88 lb

Cat. No.	UPC No.	Color	Storage Volume	Width	Depth	Height	Drawer Slides	Top Storage	Handled	Product Weight
83154	099575831546	Black/Silver	4,547 cubic in.	26.00 in	16.00 in	19.00 in	Ball Bearing	Yes	Yes	78.90 lb

GEARWRENCH® 26" 7 Drawer Roller Cabinet, XL Series

- Trigger Lock Drawer System Keeps Drawers in Place
- Ball Bearing Drawer Slides with Auto Return
- Drawer Liners in All Drawers (Black Foam)
- Brushed Aluminum Handles and Drawer Pulls
- Barrel Style Lock
- Heavy-Duty Construction
- Top Mat 1/3" (9mm) Thick
- Set of Locking Casters
- High-Gloss Scratch Resistant Powder Coat Finish
- Cabinet Body Made from 20-ga Steel. Drawers Made from 22-ga Steel



Drawer Description	Drawer Width	Drawer Depth	Drawer Height	Drawer Load Weight
2 Drawers	22.25 in	15.50 in	5.50 in	88 lb
5 Drawers	22.25 in	15.50 in	2.25 in	88 lb

Cat. No.	UPC No.	Color	Caster Size	Storage Volume	Width	Depth	Height	Load Weight	Drawer Slides	Product Weight
83155	099575831553	Black/Silver	5 in x 2 in	7,673 cubic in.	26.50 in	18.00 in	39.00 in	880 lb	Ball Bearing	158.30 lb

GEARWRENCH® 4 Drawer Tool Cart, XL Series

- Trigger Lock Drawer System Keeps Drawers in Place
- Ball Bearing Drawer Slides with Auto Return
- Drawer Liners in All Drawers (Black Foam)
- Brushed Aluminum Handles and Drawer Pulls
- Barrel Style Lock
- Heavy-Duty Construction
- Set of Locking Casters
- High-Gloss Scratch Resistant Powder Coat Finish
- Bottom Tray for Storage of Large Bulky Items
- Cart Body Made of 20-ga Steel. Drawers Made of 22-ga Steel



Drawer Description	Drawer Width	Drawer Depth	Drawer Height	Drawer Load Weight
Left - 1 Drawer	12.00 in	17.50 in	2.75 in	88 lb
Right - 1 Drawer	12.00 in	17.50 in	2.75 in	88 lb
1 Drawer	25.50 in	17.50 in	2.75 in	88 lb
1 Drawer	25.50 in	17.50 in	6.25 in	132 lb

Cat. No.	UPC No.	Color	Caster Size	Storage Volume	Width	Depth	Height	Load Weight	Handled	Product Weight
83153	099575831539	Black/Silver	5 in x 2 in	8,585 cubic in.	31.50 in	20.50 in	41.00 in	880 lb	Ergonomic	150.40 lb

GEARWRENCH® 2 Drawer Tool Cart, XL Series

- Trigger Lock Drawer System Keeps Drawers in Place
- Ball Bearing Drawer Slides with Auto Return
- Drawer Liners in All Drawers (Black Foam)
- Brushed Aluminum Handles and Drawer Pulls
- Barrel Style Lock
- Heavy-Duty Construction
- Set of Locking Casters
- High-Gloss Scratch Resistant Powder Coat Finish
- Bottom Tray for Storage of Large Bulky Items
- Cart Body Made of 20-ga Steel. Drawers Made of 22-ga Steel



Drawer Description	Drawer Width	Drawer Depth	Drawer Height	Drawer Load Weight
2 Drawers	25.50 in	17.50 in	2.75 in	88 lb

Cat. No.	UPC No.	Color	Caster Size	Storage Volume	Width	Depth	Height	Load Weight	Handled	Product Weight
83152	099575831522	Black/Silver	4 in x 1 in	4,641 cubic in.	31.50 in	20.50 in	36.00 in	880 lb	Ergonomic	110.50 lb

GEARWRENCH® 42" 10 Drawer Chest, TEP Series

- Double-Wall Construction for a Sturdy and Durable Frame
- Easy-Open Ball-Bearing Drawer Slides
- High-Gloss Scratch Resistant Powder Coat Finish
- Non-Slip Drawers
- Top Storage for Quick Access to Tools and Supplies



Drawer Description	Drawer Width	Drawer Depth	Drawer Height	Drawer Load Weight
Left - 2 Drawers	23.00 in	16.00 in	3.00 in	75 lb
Left - 3 Drawers	23.00 in	16.00 in	2.00 in	75 lb
Right - 2 Drawers	11.00 in	16.00 in	3.00 in	75 lb
Right - 3 Drawers	11.00 in	16.00 in	2.00 in	75 lb

Cat. No.	UPC No.	Color	Storage Volume	Width	Depth	Height	Drawer Slides	Top Storage	Handled	Product Weight
83126BK	099575081262	Black	6,457 cubic in.	40.50 in	17.83 in	18.38 in	Ball Bearing	Yes	No	115.00 lb
83126BU	099575832604	Blue	6,457 cubic in.	40.50 in	17.83 in	18.38 in	Ball Bearing	Yes	No	115.00 lb
83126OR	099575830266	Orange	6,457 cubic in.	40.50 in	17.83 in	18.38 in	Ball Bearing	Yes	No	115.00 lb
83126RD	099575831263	Red	6,457 cubic in.	40.50 in	17.83 in	18.38 in	Ball Bearing	Yes	No	115.00 lb

GEARWRENCH® 42" 11 Drawer Roller Cabinet, TEP Series

- Double-Wall Construction for a Sturdy and Durable Frame
- Easy-Open Ball-Bearing Drawer Slides
- High-Gloss Scratch Resistant Powder Coat Finish
- Non-Slip Drawers
- Set of Locking Casters



Drawer Description	Drawer Width	Drawer Depth	Drawer Height	Drawer Load Weight
Full Width - 1 Drawer	38.00 in	16.00 in	4.25 in	75 lb
Left - 1 Drawer	23.00 in	16.00 in	4.25 in	75 lb
Left - 1 Drawer	23.00 in	16.00 in	2.00 in	75 lb
Left - 4 Drawers	23.00 in	16.00 in	3.00 in	75 lb
Right - 1 Drawer	11.00 in	16.00 in	8.63 in	75 lb
Right - 1 Drawer	11.00 in	16.00 in	4.25 in	75 lb
Right - 2 Drawers	11.00 in	16.00 in	3.00 in	75 lb

Cat. No.	UPC No.	Color	Caster Size	Storage Volume	Width	Depth	Height	Load Weight	Drawer Slides	Product Weight
83127BK	099575830273	Black	5 in x 2 in	12,328 cubic in.	41.50 in	18.75 in	38.25 in	1100 lb	Ball Bearing	172.00 lb
83127BU	099575081279	Blue	5 in x 2 in	12,328 cubic in.	41.50 in	18.75 in	38.25 in	1100 lb	Ball Bearing	172.00 lb
83127OR	099575812705	Orange	5 in x 2 in	12,328 cubic in.	41.50 in	18.75 in	38.25 in	1100 lb	Ball Bearing	172.00 lb
83127RD	099575831270	Red	5 in x 2 in	12,328 cubic in.	41.50 in	18.75 in	38.25 in	1100 lb	Ball Bearing	172.00 lb

GEARWRENCH® 27" 6 Drawer Chest, TEP Series

- Double-Wall Construction for a Sturdy and Durable Frame
- Easy-Open Ball-Bearing Drawer Slides
- High-Gloss Scratch Resistant Powder Coat Finish
- Non-Slip Drawers
- Top Storage for Quick Access to Tools and Supplies



Drawer Description	Drawer Width	Drawer Depth	Drawer Height	Drawer Load Weight
6 Drawers	23.00 in	16.00 in	2.00 in	75 lb

Cat. No.	UPC No.	Color	Storage Volume	Width	Depth	Height	Drawer Slides	Top Storage	Handled	Product Weight
83124BK	099575081248	Black	5,991 cubic in.	26.00 in	17.825 in	20.50 in	Ball Bearing	Yes	Yes	75.00 lb
83124BU	099575832048	Blue	5,991 cubic in.	26.00 in	17.825 in	20.50 in	Ball Bearing	Yes	Yes	75.00 lb
83124RD	099575831249	Red	5,991 cubic in.	26.00 in	17.825 in	20.50 in	Ball Bearing	Yes	Yes	75.00 lb

GEARWRENCH® 27" 7 Drawer Roller Cabinet, TEP Series

- Double-Wall Construction for a Sturdy and Durable Frame
- Easy-Open Ball-Bearing Drawer Slides
- High-Gloss Scratch Resistant Powder Coat Finish
- Non-Slip Drawers
- Set of Locking Casters



Drawer Description	Drawer Width	Drawer Depth	Drawer Height	Drawer Load Weight
1 Drawer	23 in	16 in	6.50 in	75 lb
2 Drawers	23 in	16 in	4 in	75 lb
4 Drawers	23 in	16 in	2 in	75 lb

Cat. No.	UPC No.	Color	Caster Size	Storage Volume	Width	Depth	Height	Load Weight	Drawer Slides	Product Weight
83125BK	099575081255	Black	5 in x 2 in	9,604 cubic in.	27.00 in	18.75 in	35.63 in	700 lb	Ball Bearing	120.00 lb
83125BU	099575830259	Blue	5 in x 2 in	9,604 cubic in.	27.00 in	18.75 in	35.63 in	700 lb	Ball Bearing	120.00 lb
83125RD	099575831256	Red	5 in x 2 in	9,604 cubic in.	27.00 in	18.75 in	35.63 in	700 lb	Ball Bearing	120.00 lb

GEARWRENCH® 27" 4 Drawer Chest, TEP Series

- Double-Wall Construction for a Sturdy and Durable Frame
- Easy-Open Ball-Bearing Drawer Slides
- High-Gloss Scratch Resistant Powder Coat Finish
- Non-Slip Drawers
- Top Storage for Quick Access to Tools and Supplies



Drawer Description	Drawer Width	Drawer Depth	Drawer Height	Drawer Load Weight
1 Drawer	23.00 in	10.50 in	2.50 in	75 lb
3 Drawers	23.00 in	10.50 in	2.00 in	75 lb

Cat. No.	UPC No.	Color	Storage Volume	Width	Depth	Height	Drawer Slides	Top Storage	Handled	Product Weight
83122BK	099575831201	Black	3,171 cubic in.	26.00 in	12.00 in	14.50 in	Ball Bearing	Yes	Yes	41.00 lb
83122BU	099575083129	Blue	3,171 cubic in.	26.00 in	12.00 in	14.50 in	Ball Bearing	Yes	Yes	41.00 lb
83122RD	099575831225	Red	3,171 cubic in.	26.00 in	12.00 in	14.50 in	Ball Bearing	Yes	Yes	41.00 lb

GEARWRENCH® 27" 5 Drawer Roller Cabinet, TEP Series

- Double-Wall Construction for a Sturdy and Durable Frame
- Easy-Open Ball-Bearing Drawer Slides
- High-Gloss Scratch Resistant Powder Coat Finish
- Non-Slip Drawers
- Set of Locking Casters



Drawer Description	Drawer Width	Drawer Depth	Drawer Height	Drawer Load Weight
1 Drawer	23.00 in	16.00 in	2.00 in	75 lb
4 Drawers	23.00 in	16.00 in	4.00 in	75 lb

Cat. No.	UPC No.	Color	Caster Size	Storage Volume	Width	Depth	Height	Load Weight	Drawer Slides	Product Weight
83123BK	099575081231	Black	5 in x 2 in	6,594 cubic in.	27.00 in	18.75 in	31.25 in	500 lb	Ball Bearing	82.00 lb
83123BU	099575083136	Blue	5 in x 2 in	6,594 cubic in.	27.00 in	18.75 in	31.25 in	500 lb	Ball Bearing	82.00 lb
83123RD	099575831232	Red	5 in x 2 in	6,594 cubic in.	27.00 in	18.75 in	31.25 in	500 lb	Ball Bearing	82.00 lb

GEARWRENCH® 16-1/2" Plastic Tool Box

- Plastic Hand Box with Comfort Grip Handle
- Includes Tote Tray and Two Compartments in Lid



Cat. No.	UPC No.	Color	Width	Depth	Height	Storage Volume	Product Weight
83148	099575831485	Red	16.5 in	7.75 in	8.50 in	1,051 cubic in.	3.70 lb

GEARWRENCH® 19" Steel Tote Box

- Dual Latch with Lock Clasps
- Includes Tote Tray



Cat. No.	UPC No.	Color	Width	Depth	Height	Storage Volume	Product Weight
83130	099575831300	Black	19 in	6 in	6.50 in	741 cubic in.	11.61 lb

GEARWRENCH® 16" Tool Bag

- All Weather Durable Tote Bag
- Tools Pictured Not Included



Cat. No.	UPC No.	Product Weight
83147	099575831478	3.79 lb

GEARWRENCH® 20" 3 Drawer Steel Tool Box

- Portable Tool Box with Ball Bearing Drawer Slides
- Keyed Center Lock for Security
- Includes Cantilever Tray
- Top Compartment 2.5" Height
- Drawers 2" Height



Cat. No.	UPC No.	Color	Width	Depth	Height	Storage Volume	Product Weight
83151	099575831515	Black	20 in	8.5 in	12.00 in	2,040 cubic in.	20.00 lb

GEARWRENCH® 3 Pc. Socket Rail Set

- Patented Sliding Clip System Allows for Clips to Slide Within Rail and be Configurable
- Drilled at End for Easy Attachment to Wall, Workbench, or Drawer
- Made of Durable Glass Nylon

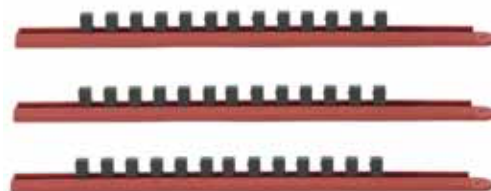

Cat. No.	UPC No.	Drive Size	Color	Length	Product Weight
83103	099575831034	1/4 in, 3/8 in, 1/2 in	Red	19.13 in	1.04 lb

GEARWRENCH® Socket Rails

- Patented Sliding Clip System Allows for Clips to Slide Within Rail and be Configurable
- Drilled at End for Easy Attachment to Wall, Workbench, or Drawer
- Made of Durable Glass Nylon



Cat. No.	UPC No.	Drive Size	Color	Length	Product Weight
83105	099575831058	1/4 in	Red	12.00 in	0.23 lb
83109	099575831096	1/4 in	Green	12.00 in	0.23 lb
83106	099575831065	1/4 in	Blue	12.00 in	0.23 lb
83101	099575831010	3/8 in	Red	18.00 in	0.37 lb
83110	099575831102	3/8 in	Green	18.00 in	0.37 lb
83107	099575831072	3/8 in	Blue	18.00 in	0.37 lb
83102	099575831027	1/2 in	Red	18.00 in	0.37 lb
83111	099575830112	1/2 in	Green	18.00 in	0.37 lb
83108	099575831089	1/2 in	Blue	18.00 in	0.37 lb

GEARWRENCH® Socket Rail Clips Sets

- Heavy Duty Black Plastic Clips Hold Sockets Firmly
- Quantity of 3 per Shelf Pack

Cat. No.	UPC No.	Drive Size	Color	Product Weight
83112	099575081125	1/4 in	Black	0.02 lb
83113	099575831133	3/8 in	Black	0.03 lb
83114	099575081149	1/2 in	Black	0.05 lb



GEARWRENCH® Mag-Rail Magnetic Tool Holders

- Neatly Stores Sockets, Screwdrivers or Other Tools
- Magnetic Rail Can Be Mounted on Wall or in Tool Box Through Pre-drilled Holes



Cat. No.	UPC No.	Length	Product Weight
3155D	082171031557	17.00 in	0.70 lb

GEARWRENCH® Universal Magnetic Parts Tray, 6" Circular

- Non-Scratch Magnet
- Protective Cover

Cat. No.	UPC No.	Packaging	Product Weight
83104	099575831041	Carded	1.80 lb



GEARWRENCH® Universal Magnetic Parts Tray, Rectangular

- Non-Scratch Magnet
- Protective Cover
- Mounts Horizontally or Vertically

Cat. No.	UPC No.	Packaging	Length	Width	Product Weight
83115	099575831157	Carded	9-5/8 in	5-11/16 in	2.55 lb





GEARWRENCH®

Multidrive Sets.....	38
1/4" Drive Sets	66
1/4" Drive Open Stock.....	83
3/8" Drive Sets	100
3/8" Drive Open Stock.....	124
1/2" Drive Sets	147
1/2" Drive Open Stock.....	164
3/4" Drive Sets	176
3/4" Drive Open Stock.....	177
XL Pass-Thru Ratchet System	179

GEARWRENCH® Ratchets, Sockets, Drive Tools

GearWrench® has been the leader in ratchet innovation since its introduction. What started with the patented “NGR” (Next Generation Ratchet) has evolved into the 120XP™ – the new 120 position ratchet that has quickly become the industry leader in performance, providing speed, strength and access.

GearWrench® offers a complete line of ratchets, sockets, and drive tools available individually or in sets. All are made of only the finest materials for a long productive life.

120XP

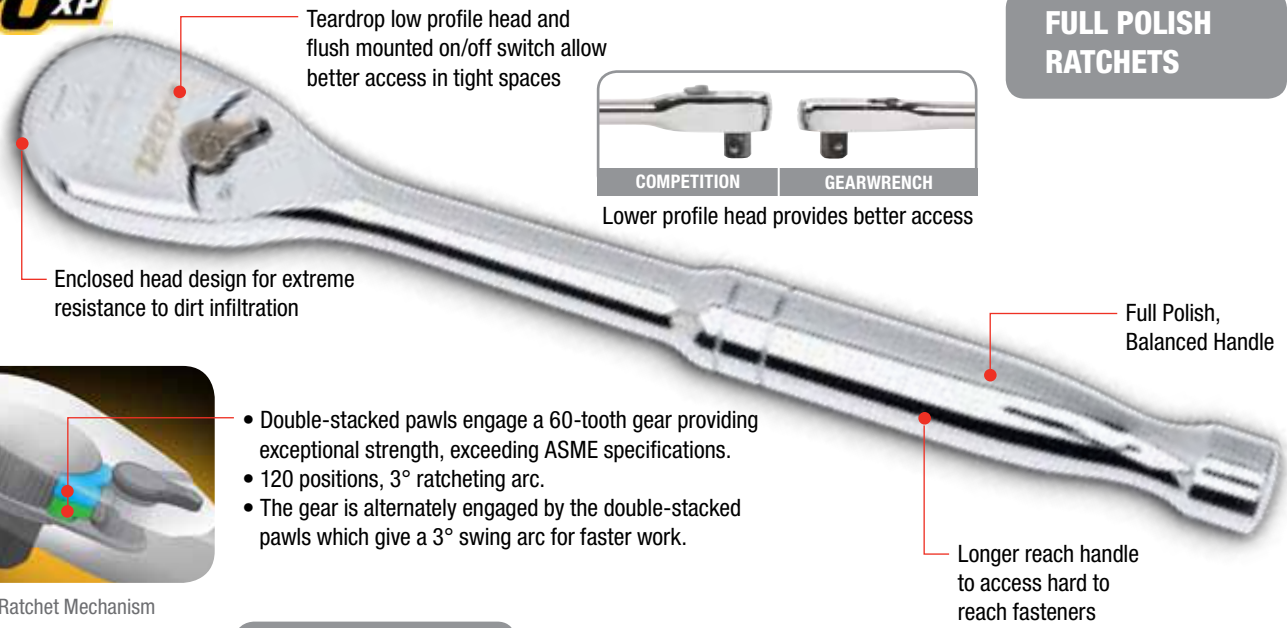

Teardrop low profile head and flush mounted on/off switch allow better access in tight spaces

Enclosed head design for extreme resistance to dirt infiltration

FULL POLISH RATCHETS



Lower profile head provides better access

Full Polish, Balanced Handle

Longer reach handle to access hard to reach fasteners

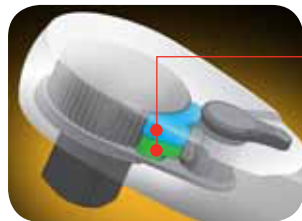

- Double-stacked pawls engage a 60-tooth gear providing exceptional strength, exceeding ASME specifications.
- 120 positions, 3° ratcheting arc.
- The gear is alternately engaged by the double-stacked pawls which give a 3° swing arc for faster work.

120XP Ratchet Mechanism

CUSHION GRIP RATCHETS



Flush Mounted On/Off Switch

Longer than most ratchets for added leverage

ROTO RATCHETS



Fine Tooth 72 Teeth

Dual Material Cushion Grip

Head Rotates 180 Degrees

Less Than 5 Degree Swing Arc for Greater Access



GIMBAL RATCHETS

72-Tooth Ratcheting Mechanism for 5 Degree Swing Arc

Thumbwheel outer ring has finger recesses for comfortable grip

Meets or exceeds ASME performance requirements



Gimbal design allows ratchet to pivot in two directions for easier access



Anodised Color-coded Aluminum Finish

Easy-to-use Forward/Reverse Lever

SOCKETS

- AVAILABLE IN:**
- Standard
 - Mid-Length
 - Deep
 - Spark Plug
 - Flex



Entry angle guides fastener

Serration depth as deep as the fastener

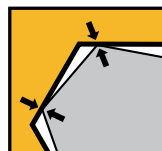

Ordinary Socket



Surface Drive® Technology



Large hard-stamped identification

Double Line (SAE) & Knurled Line (MM) to easily identify Standard vs. Metric Sockets



MAGNETIC DRIVE TOOLS



Knurled grip provides non-slip surface

Strong magnetic tips allow for contact through the base of the socket to hold nuts and bolts in place during use.

Magnetic tip keeps the fastener in the sockets



GEARWRENCH® 239 Pc. 1/4", 3/8", and 1/2" Drive 6 and 12 Point SAE/Metric Mechanics Tool Set

- Includes 3-Drawer Storage Box
- Full Polish Chrome Sockets With Large Hard Stamp Size Markings
- Full Polish Chrome Combination Wrenches Feature Offset Box End and Surface Drive® Technology To Reduce Fastener Rounding
- 45 Tooth Full Polish Chrome Quick-Release Ratchets
- The Original ALLEN® Brand Hex Keys
- Knurled Full Polish Chrome Extensions
- Magnetic Bit Driver With Ergonomic Dual Material Handle
- Sockets Feature Surface Drive® Technology To Reduce Fastener Rounding
- Meets or Exceeds ASME B107.1, B107.5M, B107.10, B107.6



Cat. No.	UPC No.	Packaging	Product Weight
80934	099575809347	Boxed	43.00 lb

Catalog No.	Description	Catalog No.	Description
81014	1/4" Drive Teardrop Quick Release Ratchet	81659	11/16" Long Pattern Combination Wrench
81218	3/8" Drive Teardrop Quick Release Ratchet	81660	3/4" Long Pattern Combination Wrench
81309	1/2" Drive Quick Release Tear Drop Ratchet	81736	6mm Long Pattern Combination Wrench
82783	Magnetic Bit Holding Screwdriver 1/4"	81737	7mm Long Pattern Combination Wrench
56603G	13 Piece Long Arm SAE Hex Key Set	81665	8mm Long Pattern Combination Wrench
56606G	9 Piece Long Arm Metric Hex Key Set	81666	9mm Long Pattern Combination Wrench
81101	1/4" Drive Standard Extension 2"	81667	10mm Long Pattern Combination Wrench
81113D	1/4" Drive Standard Extension 3"	81668	11mm Long Pattern Combination Wrench
81116	1/4" Drive Standard Extension 6"	81669	12mm Long Pattern Combination Wrench
81241	3/8" Drive Standard Extension 3"	81670	13mm Long Pattern Combination Wrench
81242	3/8" Drive Standard Extension 6"	81671	14mm Long Pattern Combination Wrench
81340	1/2" Drive Standard Extension 3"	81672	15mm Long Pattern Combination Wrench
81341	1/2" Drive Standard Extension 5"	81673	16mm Long Pattern Combination Wrench
81650	1/4" Long Pattern Combination Wrench	81674	17mm Long Pattern Combination Wrench
81652D	5/16" Long Pattern Combination Wrench	81675	18mm Long Pattern Combination Wrench
81653	11/32" Long Pattern Combination Wrench	81676	19mm Long Pattern Combination Wrench
81654	3/8" Long Pattern Combination Wrench	80104D	1/4" Drive 6 Point Standard SAE Socket 5/32"
81655	7/16" Long Pattern Combination Wrench	80105	1/4" Drive 6 Point Standard SAE Socket 3/16"
81656	1/2" Long Pattern Combination Wrench	80106	1/4" Drive 6 Point Standard SAE Socket 7/32"
81657	9/16" Long Pattern Combination Wrench	80107	1/4" Drive 6 Point Standard SAE Socket 1/4"
81658	5/8" Long Pattern Combination Wrench	80108	1/4" Drive 6 Point Standard SAE Socket 9/32"

MULTIDRIVE

3

RATCHETS / SOCKETS / DRIVE TOOLS / SETS

Catalog No.	Description	Catalog No.	Description
80109	1/4" Drive 6 Point Standard SAE Socket 5/16"	80218	1/4" Drive 12 Point Standard SAE Socket 1/2"
80110	1/4" Drive 6 Point Standard SAE Socket 11/32"	80219	1/4" Drive 12 Point Standard SAE Socket 9/16"
80111	1/4" Drive 6 Point Standard SAE Socket 3/8"	80350	3/8" Drive 6 Point Standard SAE Socket 1/4"
80112	1/4" Drive 6 Point Standard SAE Socket 7/16"	80351	3/8" Drive 6 Point Standard SAE Socket 5/16"
80113D	1/4" Drive 6 Point Standard SAE Socket 1/2"	80352	3/8" Drive 6 Point Standard SAE Socket 3/8"
80114D	1/4" Drive 6 Point Standard SAE Socket 9/16"	80353	3/8" Drive 6 Point Standard SAE Socket 7/16"
80115	1/4" Drive 6 Point Deep SAE Socket 3/16"	80354	3/8" Drive 6 Point Standard SAE Socket 1/2"
80116D	1/4" Drive 6 Point Deep SAE Socket 7/32"	80355	3/8" Drive 6 Point Standard SAE Socket 9/16"
80117	1/4" Drive 6 Point Deep SAE Socket 1/4"	80356	3/8" Drive 6 Point Standard SAE Socket 5/8"
80118	1/4" Drive 6 Point Deep SAE Socket 9/32"	80357	3/8" Drive 6 Point Standard SAE Socket 11/16"
80119	1/4" Drive 6 Point Deep SAE Socket 5/16"	80358	3/8" Drive 6 Point Standard SAE Socket 3/4"
80120D	1/4" Drive 6 Point Deep SAE Socket 11/32"	80359	3/8" Drive 6 Point Standard SAE Socket 13/16"
80121	1/4" Drive 6 Point Deep SAE Socket 3/8"	80360	3/8" Drive 6 Point Standard SAE Socket 7/8"
80122D	1/4" Drive 6 Point Deep SAE Socket 7/16"	80365	3/8" Drive 6 Point Deep SAE Socket 3/8"
80123	1/4" Drive 6 Point Deep SAE Socket 1/2"	80366	3/8" Drive 6 Point Deep SAE Socket 7/16"
80124	1/4" Drive 6 Point Deep SAE Socket 9/16"	80367	3/8" Drive 6 Point Deep SAE Socket 1/2"
80125	1/4" Drive 6 Point Standard Metric Socket 4mm	80368	3/8" Drive 6 Point Deep SAE Socket 9/16"
80126	1/4" Drive 6 Point Standard Metric Socket 5mm	80369	3/8" Drive 6 Point Deep SAE Socket 5/8"
80127	1/4" Drive 6 Point Standard Metric Socket 5.5mm	80370D	3/8" Drive 6 Point Deep SAE Socket 11/16"
80128	1/4" Drive 6 Point Standard Metric Socket 6mm	80371	3/8" Drive 6 Point Deep SAE Socket 3/4"
80129	1/4" Drive 6 Point Standard Metric Socket 7mm	80374	3/8" Drive 6 Point Standard Metric Socket 6mm
80130	1/4" Drive 6 Point Standard Metric Socket 8mm	80375	3/8" Drive 6 Point Standard Metric Socket 7mm
80131D	1/4" Drive 6 Point Standard Metric Socket 9mm	80376	3/8" Drive 6 Point Standard Metric Socket 8mm
80132	1/4" Drive 6 Point Standard Metric Socket 10mm	80377	3/8" Drive 6 Point Standard Metric Socket 9mm
80133	1/4" Drive 6 Point Standard Metric Socket 11mm	80378	3/8" Drive 6 Point Standard Metric Socket 10mm
80134	1/4" Drive 6 Point Standard Metric Socket 12mm	80379	3/8" Drive 6 Point Standard Metric Socket 11mm
80135D	1/4" Drive 6 Point Standard Metric Socket 13mm	80380	3/8" Drive 6 Point Standard Metric Socket 12mm
80136	1/4" Drive 6 Point Standard Metric Socket 14mm	80381	3/8" Drive 6 Point Standard Metric Socket 13mm
80137	1/4" Drive 6 Point Standard Metric Socket 15mm	80382	3/8" Drive 6 Point Standard Metric Socket 14mm
80138	1/4" Drive 6 Point Deep Metric Socket 4mm	80383	3/8" Drive 6 Point Standard Metric Socket 15mm
80139	1/4" Drive 6 Point Deep Metric Socket 5mm	80384	3/8" Drive 6 Point Standard Metric Socket 16mm
80141	1/4" Drive 6 Point Deep Metric Socket 6mm	80385	3/8" Drive 6 Point Standard Metric Socket 17mm
80142	1/4" Drive 6 Point Deep Metric Socket 7mm	80386	3/8" Drive 6 Point Standard Metric Socket 18mm
80143	1/4" Drive 6 Point Deep Metric Socket 8mm	80387	3/8" Drive 6 Point Standard Metric Socket 19mm
80144	1/4" Drive 6 Point Deep Metric Socket 9mm	80330	3/8" Drive 6 Point Standard Metric Socket 20mm
80145	1/4" Drive 6 Point Deep Metric Socket 10mm	80331	3/8" Drive 6 Point Standard Metric Socket 21mm
80146D	1/4" Drive 6 Point Deep Metric Socket 11mm	80332	3/8" Drive 6 Point Standard Metric Socket 22mm
80147	1/4" Drive 6 Point Deep Metric Socket 12mm	80391	3/8" Drive 6 Point Deep Metric Socket 9mm
80148	1/4" Drive 6 Point Deep Metric Socket 13mm	80392	3/8" Drive 6 Point Deep Metric Socket 10mm
80149	1/4" Drive 6 Point Deep Metric Socket 14mm	80393D	3/8" Drive 6 Point Deep Metric Socket 11mm
80210	1/4" Drive 12 Point Standard SAE Socket 3/16"	80394D	3/8" Drive 6 Point Deep Metric Socket 12mm
80211	1/4" Drive 12 Point Standard SAE Socket 7/32"	80395	3/8" Drive 6 Point Deep Metric Socket 13mm
80212	1/4" Drive 12 Point Standard SAE Socket 1/4"	80396	3/8" Drive 6 Point Deep Metric Socket 14mm
80213	1/4" Drive 12 Point Standard SAE Socket 9/32"	80397	3/8" Drive 6 Point Deep Metric Socket 15mm
80214	1/4" Drive 12 Point Standard SAE Socket 5/16"	80398	3/8" Drive 6 Point Deep Metric Socket 16mm
80215D	1/4" Drive 12 Point Standard SAE Socket 11/32"	80399	3/8" Drive 6 Point Deep Metric Socket 17mm
80216	1/4" Drive 12 Point Standard SAE Socket 3/8"	80400	3/8" Drive 6 Point Deep Metric Socket 18mm
80217	1/4" Drive 12 Point Standard SAE Socket 7/16"	80401	3/8" Drive 6 Point Deep Metric Socket 19mm

Contents continued on next page.

Catalog No.	Description	Catalog No.	Description
80496	3/8" Drive 12 Point Standard SAE Socket 1/4"	80794	1/2" Drive 12 Point Standard SAE Socket 1-1/4"
80498	3/8" Drive 12 Point Standard SAE Socket 3/8"	80680	1/2" Drive 12 Point Standard SAE Socket 1-1/2"
80499	3/8" Drive 12 Point Standard SAE Socket 7/16"	80750	1/2" Drive 12 Point Standard Metric Socket 15mm
80500D	3/8" Drive 12 Point Standard SAE Socket 1/2"	80751	1/2" Drive 12 Point Standard Metric Socket 16mm
80501	3/8" Drive 12 Point Standard SAE Socket 9/16"	80752	1/2" Drive 12 Point Standard Metric Socket 17mm
80502	3/8" Drive 12 Point Standard SAE Socket 5/8"	80753	1/2" Drive 12 Point Standard Metric Socket 18mm
80503	3/8" Drive 12 Point Standard SAE Socket 11/16"	80754	1/2" Drive 12 Point Standard Metric Socket 19mm
80504	3/8" Drive 12 Point Standard SAE Socket 3/4"	80755D	1/2" Drive 12 Point Standard Metric Socket 20mm
80505	3/8" Drive 12 Point Standard SAE Socket 13/16"	80756	1/2" Drive 12 Point Standard Metric Socket 21mm
80506D	3/8" Drive 12 Point Standard SAE Socket 7/8"	80757	1/2" Drive 12 Point Standard Metric Socket 22mm
80482	3/8" Drive 12 Point Standard Metric Socket 6mm	80758	1/2" Drive 12 Point Standard Metric Socket 23mm
80483	3/8" Drive 12 Point Standard Metric Socket 7mm	80759	1/2" Drive 12 Point Standard Metric Socket 24mm
80484	3/8" Drive 12 Point Standard Metric Socket 8mm	80811	1/2" Drive 12 Point Standard Metric Socket 25mm
80485	3/8" Drive 12 Point Standard Metric Socket 9mm	80681	1/2" Drive 12 Point Standard Metric Socket 26mm
80486	3/8" Drive 12 Point Standard Metric Socket 10mm	80812	1/2" Drive 12 Point Standard Metric Socket 27mm
80487	3/8" Drive 12 Point Standard Metric Socket 11mm	80402	3/8" Drive Spark Plug Socket 5/8"
80488	3/8" Drive 12 Point Standard Metric Socket 12mm	80403	3/8" Drive Spark Plug Socket 13/16"
80489	3/8" Drive 12 Point Standard Metric Socket 13mm	-	#1 Phillips Bit
80490	3/8" Drive 12 Point Standard Metric Socket 14mm	-	#2 Phillips Bit
80491	3/8" Drive 12 Point Standard Metric Socket 15mm	-	#3 Phillips Bit
80492	3/8" Drive 12 Point Standard Metric Socket 16mm	-	4mm Slotted Bit
80493	3/8" Drive 12 Point Standard Metric Socket 17mm	-	5mm Slotted Bit
80494	3/8" Drive 12 Point Standard Metric Socket 18mm	-	6mm Slotted Bit
80495	3/8" Drive 12 Point Standard Metric Socket 19mm	-	T-40 Torx® Bit
80596	3/8" Drive 12 Point Standard Metric Socket 20mm	-	T-45 Torx® Bit
80597	3/8" Drive 12 Point Standard Metric Socket 21mm	-	T-50 Torx® Bit
80598	3/8" Drive 12 Point Standard Metric Socket 22mm	-	3/16" Nutdriver Bit
80760	1/2" Drive 12 Point Standard SAE Socket 7/16"	-	1/4" Nutdriver Bit
80761	1/2" Drive 12 Point Standard SAE Socket 1/2"	-	5/16" Nutdriver Bit
80762	1/2" Drive 12 Point Standard SAE Socket 9/16"	-	11/32" Nutdriver Bit
80763	1/2" Drive 12 Point Standard SAE Socket 5/8"	-	3/8" Nutdriver Bit
80764	1/2" Drive 12 Point Standard SAE Socket 11/16"	-	7/16" Nutdriver Bit
80765	1/2" Drive 12 Point Standard SAE Socket 3/4"	-	1/2" Nutdriver Bit
80766	1/2" Drive 12 Point Standard SAE Socket 13/16"	-	5mm Nutdriver Bit
80767	1/2" Drive 12 Point Standard SAE Socket 7/8"	-	6mm Nutdriver Bit
80768	1/2" Drive 12 Point Standard SAE Socket 15/16"	-	7mm Nutdriver Bit
80769	1/2" Drive 12 Point Standard SAE Socket 1"	-	8mm Nutdriver Bit
80770	1/2" Drive 12 Point Standard SAE Socket 1-1/16"	-	9mm Nutdriver Bit
80771	1/2" Drive 12 Point Standard SAE Socket 1-1/8"	-	10mm Nutdriver Bit
80793	1/2" Drive 12 Point Standard SAE Socket 1-3/16"	-	11mm Nutdriver Bit

GEARWRENCH® 216 Pc. 1/4", 3/8", and 1/2" Drive 6 and 12 Point SAE/Metric Mechanics Tool Set

- Includes Storage Case
- Full Polish Chrome Sockets With Large Hard Stamp Size Markings
- Full Polish Chrome Combination Wrenches Feature Offset Box End and Surface Drive® Technology To Reduce Fastener Rounding
- 45 Tooth Full Polish Chrome Quick-Release Ratchets
- The Original ALLEN® Brand Hex Keys
- Knurled Full Polish Chrome Extensions
- Magnetic Bit Driver With Ergonomic Dual Material Handle
- Sockets Feature Surface Drive® Technology To Reduce Fastener Rounding
- Meets or Exceeds ASME B107.1, B107.5M, B107.10, B107.6



Cat. No.	UPC No.	Packaging	Product Weight
80933	099575809330	Boxed	15.00 lb

Catalog No.	Description	Catalog No.	Description
81014	1/4" Drive Teardrop Quick Release Ratchet	81671	14mm Long Pattern Combination Wrench
81218	3/8" Drive Teardrop Quick Release Ratchet	81672	15mm Long Pattern Combination Wrench
81309	1/2" Drive Quick Release Tear Drop Ratchet	80104D	1/4" Drive 6 Point Standard SAE Socket 5/32"
56603G	13 Piece Long Arm SAE Hex Key Set	80105	1/4" Drive 6 Point Standard SAE Socket 3/16"
56606G	9 Piece Long Arm Metric Hex Key Set	80106	1/4" Drive 6 Point Standard SAE Socket 7/32"
80480	1/4" Bit Adapter 1/4" Drive	80107	1/4" Drive 6 Point Standard SAE Socket 1/4"
81128	1/4" Socket Driver	80108	1/4" Drive 6 Point Standard SAE Socket 9/32"
81113D	1/4" Drive Standard Extension 3"	80109	1/4" Drive 6 Point Standard SAE Socket 5/16"
81241	3/8" Drive Standard Extension 3"	80110	1/4" Drive 6 Point Standard SAE Socket 11/32"
81242	3/8" Drive Standard Extension 6"	80111	1/4" Drive 6 Point Standard SAE Socket 3/8"
81340	1/2" Drive Standard Extension 3"	80112	1/4" Drive 6 Point Standard SAE Socket 7/16"
81650	1/4" Long Pattern Combination Wrench	80113D	1/4" Drive 6 Point Standard SAE Socket 1/2"
81652D	5/16" Long Pattern Combination Wrench	80114D	1/4" Drive 6 Point Standard SAE Socket 9/16"
81653	11/32" Long Pattern Combination Wrench	80115	1/4" Drive 6 Point Deep SAE Socket 3/16"
81654	3/8" Long Pattern Combination Wrench	80116D	1/4" Drive 6 Point Deep SAE Socket 7/32"
81655	7/16" Long Pattern Combination Wrench	80117	1/4" Drive 6 Point Deep SAE Socket 1/4"
81656	1/2" Long Pattern Combination Wrench	80118	1/4" Drive 6 Point Deep SAE Socket 9/32"
81657	9/16" Long Pattern Combination Wrench	80119	1/4" Drive 6 Point Deep SAE Socket 5/16"
81658	5/8" Long Pattern Combination Wrench	80120D	1/4" Drive 6 Point Deep SAE Socket 11/32"
81659	11/16" Long Pattern Combination Wrench	80121	1/4" Drive 6 Point Deep SAE Socket 3/8"
81660	3/4" Long Pattern Combination Wrench	80122D	1/4" Drive 6 Point Deep SAE Socket 7/16"
81737	7mm Long Pattern Combination Wrench	80123	1/4" Drive 6 Point Deep SAE Socket 1/2"
81665	8mm Long Pattern Combination Wrench	80124	1/4" Drive 6 Point Deep SAE Socket 9/16"
81666	9mm Long Pattern Combination Wrench	80125	1/4" Drive 6 Point Standard Metric Socket 4mm
81667	10mm Long Pattern Combination Wrench	80126	1/4" Drive 6 Point Standard Metric Socket 5mm
81668	11mm Long Pattern Combination Wrench	80127	1/4" Drive 6 Point Standard Metric Socket 5.5mm
81669	12mm Long Pattern Combination Wrench	80128	1/4" Drive 6 Point Standard Metric Socket 6mm
81670	13mm Long Pattern Combination Wrench	80129	1/4" Drive 6 Point Standard Metric Socket 7mm

Contents continued on next page.

MULTIDRIVE

3

RATCHETS / SOCKETS / DRIVE TOOLS / SETS

Catalog No.	Description	Catalog No.	Description
80130	1/4" Drive 6 Point Standard Metric Socket 8mm	80330	3/8" Drive 6 Point Standard Metric Socket 20mm
80131D	1/4" Drive 6 Point Standard Metric Socket 9mm	80331	3/8" Drive 6 Point Standard Metric Socket 21mm
80132	1/4" Drive 6 Point Standard Metric Socket 10mm	80332	3/8" Drive 6 Point Standard Metric Socket 22mm
80133	1/4" Drive 6 Point Standard Metric Socket 11mm	80391	3/8" Drive 6 Point Deep Metric Socket 9mm
80134	1/4" Drive 6 Point Standard Metric Socket 12mm	80392	3/8" Drive 6 Point Deep Metric Socket 10mm
80135D	1/4" Drive 6 Point Standard Metric Socket 13mm	80393D	3/8" Drive 6 Point Deep Metric Socket 11mm
80136	1/4" Drive 6 Point Standard Metric Socket 14mm	80394D	3/8" Drive 6 Point Deep Metric Socket 12mm
80137	1/4" Drive 6 Point Standard Metric Socket 15mm	80395	3/8" Drive 6 Point Deep Metric Socket 13mm
80138	1/4" Drive 6 Point Deep Metric Socket 4mm	80396	3/8" Drive 6 Point Deep Metric Socket 14mm
80139	1/4" Drive 6 Point Deep Metric Socket 5mm	80397	3/8" Drive 6 Point Deep Metric Socket 15mm
80141	1/4" Drive 6 Point Deep Metric Socket 6mm	80398	3/8" Drive 6 Point Deep Metric Socket 16mm
80142	1/4" Drive 6 Point Deep Metric Socket 7mm	80399	3/8" Drive 6 Point Deep Metric Socket 17mm
80143	1/4" Drive 6 Point Deep Metric Socket 8mm	80400	3/8" Drive 6 Point Deep Metric Socket 18mm
80144	1/4" Drive 6 Point Deep Metric Socket 9mm	80401	3/8" Drive 6 Point Deep Metric Socket 19mm
80145	1/4" Drive 6 Point Deep Metric Socket 10mm	80496	3/8" Drive 12 Point Standard SAE Socket 1/4"
80146D	1/4" Drive 6 Point Deep Metric Socket 11mm	80497D	3/8" Drive 12 Point Standard SAE Socket 5/16"
80147	1/4" Drive 6 Point Deep Metric Socket 12mm	80498	3/8" Drive 12 Point Standard SAE Socket 3/8"
80148	1/4" Drive 6 Point Deep Metric Socket 13mm	80499	3/8" Drive 12 Point Standard SAE Socket 7/16"
80149	1/4" Drive 6 Point Deep Metric Socket 14mm	80500D	3/8" Drive 12 Point Standard SAE Socket 1/2"
80350	3/8" Drive 6 Point Standard SAE Socket 1/4"	80501	3/8" Drive 12 Point Standard SAE Socket 9/16"
80351	3/8" Drive 6 Point Standard SAE Socket 5/16"	80502	3/8" Drive 12 Point Standard SAE Socket 5/8"
80352	3/8" Drive 6 Point Standard SAE Socket 3/8"	80503	3/8" Drive 12 Point Standard SAE Socket 11/16"
80353	3/8" Drive 6 Point Standard SAE Socket 7/16"	80504	3/8" Drive 12 Point Standard SAE Socket 3/4"
80354	3/8" Drive 6 Point Standard SAE Socket 1/2"	80505	3/8" Drive 12 Point Standard SAE Socket 13/16"
80355	3/8" Drive 6 Point Standard SAE Socket 9/16"	80506D	3/8" Drive 12 Point Standard SAE Socket 7/8"
80356	3/8" Drive 6 Point Standard SAE Socket 5/8"	80485	3/8" Drive 12 Point Standard Metric Socket 9mm
80357	3/8" Drive 6 Point Standard SAE Socket 11/16"	80486	3/8" Drive 12 Point Standard Metric Socket 10mm
80358	3/8" Drive 6 Point Standard SAE Socket 3/4"	80487	3/8" Drive 12 Point Standard Metric Socket 11mm
80359	3/8" Drive 6 Point Standard SAE Socket 13/16"	80488	3/8" Drive 12 Point Standard Metric Socket 12mm
80360	3/8" Drive 6 Point Standard SAE Socket 7/8"	80489	3/8" Drive 12 Point Standard Metric Socket 13mm
80365	3/8" Drive 6 Point Deep SAE Socket 3/8"	80490	3/8" Drive 12 Point Standard Metric Socket 14mm
80366	3/8" Drive 6 Point Deep SAE Socket 7/16"	80491	3/8" Drive 12 Point Standard Metric Socket 15mm
80367	3/8" Drive 6 Point Deep SAE Socket 1/2"	80492	3/8" Drive 12 Point Standard Metric Socket 16mm
80368	3/8" Drive 6 Point Deep SAE Socket 9/16"	80493	3/8" Drive 12 Point Standard Metric Socket 17mm
80369	3/8" Drive 6 Point Deep SAE Socket 5/8"	80494	3/8" Drive 12 Point Standard Metric Socket 18mm
80370D	3/8" Drive 6 Point Deep SAE Socket 11/16"	80495	3/8" Drive 12 Point Standard Metric Socket 19mm
80371	3/8" Drive 6 Point Deep SAE Socket 3/4"	80596	3/8" Drive 12 Point Standard Metric Socket 20mm
80377	3/8" Drive 6 Point Standard Metric Socket 9mm	80597	3/8" Drive 12 Point Standard Metric Socket 21mm
80378	3/8" Drive 6 Point Standard Metric Socket 10mm	80598	3/8" Drive 12 Point Standard Metric Socket 22mm
80379	3/8" Drive 6 Point Standard Metric Socket 11mm	80760	1/2" Drive 12 Point Standard SAE Socket 7/16"
80380	3/8" Drive 6 Point Standard Metric Socket 12mm	80761	1/2" Drive 12 Point Standard SAE Socket 1/2"
80381	3/8" Drive 6 Point Standard Metric Socket 13mm	80762	1/2" Drive 12 Point Standard SAE Socket 9/16"
80382	3/8" Drive 6 Point Standard Metric Socket 14mm	80763	1/2" Drive 12 Point Standard SAE Socket 5/8"
80383	3/8" Drive 6 Point Standard Metric Socket 15mm	80764	1/2" Drive 12 Point Standard SAE Socket 11/16"
80384	3/8" Drive 6 Point Standard Metric Socket 16mm	80765	1/2" Drive 12 Point Standard SAE Socket 3/4"
80385	3/8" Drive 6 Point Standard Metric Socket 17mm	80766	1/2" Drive 12 Point Standard SAE Socket 13/16"
80386	3/8" Drive 6 Point Standard Metric Socket 18mm	80767	1/2" Drive 12 Point Standard SAE Socket 7/8"
80387	3/8" Drive 6 Point Standard Metric Socket 19mm	80768	1/2" Drive 12 Point Standard SAE Socket 15/16"

Catalog No.	Description	Catalog No.	Description
80769	1/2" Drive 12 Point Standard SAE Socket 1"	-	#2 Phillips Bit
80770	1/2" Drive 12 Point Standard SAE Socket 1-1/16"	-	#3 Phillips Bit
80771	1/2" Drive 12 Point Standard SAE Socket 1-1/8"	-	4mm Slotted Bit
80793	1/2" Drive 12 Point Standard SAE Socket 1-3/16"	-	5mm Slotted Bit
80794	1/2" Drive 12 Point Standard SAE Socket 1-1/4"	-	6mm Slotted Bit
80680	1/2" Drive 12 Point Standard SAE Socket 1-1/2"	-	T-40 Torx® Bit
80750	1/2" Drive 12 Point Standard Metric Socket 15mm	-	T-45 Torx® Bit
80751	1/2" Drive 12 Point Standard Metric Socket 16mm	-	T-50 Torx® Bit
80752	1/2" Drive 12 Point Standard Metric Socket 17mm	-	3/16" Nutdriver Bit
80753	1/2" Drive 12 Point Standard Metric Socket 18mm	-	1/4" Nutdriver Bit
80754	1/2" Drive 12 Point Standard Metric Socket 19mm	-	5/16" Nutdriver Bit
80756	1/2" Drive 12 Point Standard Metric Socket 21mm	-	11/32" Nutdriver Bit
80757	1/2" Drive 12 Point Standard Metric Socket 22mm	-	3/8" Nutdriver Bit
80759	1/2" Drive 12 Point Standard Metric Socket 24mm	-	7/16" Nutdriver Bit
80811	1/2" Drive 12 Point Standard Metric Socket 25mm	-	1/2" Nutdriver Bit
80812	1/2" Drive 12 Point Standard Metric Socket 27mm	-	5mm Nutdriver Bit
80682	1/2" Drive 12 Point Standard Metric Socket 28mm	-	6mm Nutdriver Bit
80813	1/2" Drive 12 Point Standard Metric Socket 30mm	-	7mm Nutdriver Bit
80814D	1/2" Drive 12 Point Standard Metric Socket 32mm	-	8mm Nutdriver Bit
80402	3/8" Drive Spark Plug Socket 5/8"	-	11mm Nutdriver Bit
80403	3/8" Drive Spark Plug Socket 13/16"	-	9mm Nutdriver Bit
-	#1 Phillips Bit	-	10mm Nutdriver Bit

GEARWRENCH® 165 Pc. 1/4", 3/8", and 1/2" Drive 6 and 12 Point SAE/Metric Mechanics Tool Set

- Includes Storage Case
- Full Polish Chrome Sockets With Large Hard Stamp Size Markings
- Full Polish Chrome Combination Wrenches Feature Offset Box End and Surface Drive® Technology To Reduce Fastener Rounding
- 45 Tooth Full Polish Chrome Quick-Release Ratchets
- The Original ALLEN® Brand Hex Keys
- Magnetic Bit Driver With Ergonomic Dual Material Handle
- Sockets Feature Surface Drive® Technology To Reduce Fastener Rounding
- Meets or Exceeds ASME B107.1, B107.5M, B107.10, B107.6



MULTIDRIVE

3

RATCHETS / SOCKETS / DRIVE TOOLS / SETS

Cat. No.	UPC No.	Packaging	Product Weight
80932	099575809323	Boxed	23.54 lb

Catalog No.	Description	Catalog No.	Description
81014	1/4" Drive Teardrop Quick Release Ratchet	81670	13mm Long Pattern Combination Wrench
81218	3/8" Drive Teardrop Quick Release Ratchet	81671	14mm Long Pattern Combination Wrench
81309	1/2" Drive Quick Release Tear Drop Ratchet	81672	15mm Long Pattern Combination Wrench
81128	1/4" Socket Driver	80105	1/4" Drive 6 Point Standard SAE Socket 3/16"
56603G	13 Piece Long Arm SAE Hex Key Set	80106	1/4" Drive 6 Point Standard SAE Socket 7/32"
56606G	9 Piece Long Arm Metric Hex Key Set	80107	1/4" Drive 6 Point Standard SAE Socket 1/4"
80480	1/4" Bit Adapter 1/4" Drive	80108	1/4" Drive 6 Point Standard SAE Socket 9/32"
81113D	1/4" Drive Standard Extension 3"	80109	1/4" Drive 6 Point Standard SAE Socket 5/16"
81241	3/8" Drive Standard Extension 3"	80110	1/4" Drive 6 Point Standard SAE Socket 11/32"
81242	3/8" Drive Standard Extension 6"	80111	1/4" Drive 6 Point Standard SAE Socket 3/8"
81340	1/2" Drive Standard Extension 3"	80112	1/4" Drive 6 Point Standard SAE Socket 7/16"
81650	1/4" Long Pattern Combination Wrench	80113D	1/4" Drive 6 Point Standard SAE Socket 1/2"
81652D	5/16" Long Pattern Combination Wrench	80114D	1/4" Drive 6 Point Standard SAE Socket 9/16"
81653	11/32" Long Pattern Combination Wrench	80115	1/4" Drive 6 Point Deep SAE Socket 3/16"
81654	3/8" Long Pattern Combination Wrench	80116D	1/4" Drive 6 Point Deep SAE Socket 7/32"
81655	7/16" Long Pattern Combination Wrench	80117	1/4" Drive 6 Point Deep SAE Socket 1/4"
81656	1/2" Long Pattern Combination Wrench	80118	1/4" Drive 6 Point Deep SAE Socket 9/32"
81657	9/16" Long Pattern Combination Wrench	80119	1/4" Drive 6 Point Deep SAE Socket 5/16"
81658	5/8" Long Pattern Combination Wrench	80120D	1/4" Drive 6 Point Deep SAE Socket 11/32"
81659	11/16" Long Pattern Combination Wrench	80121	1/4" Drive 6 Point Deep SAE Socket 3/8"
81660	3/4" Long Pattern Combination Wrench	80122D	1/4" Drive 6 Point Deep SAE Socket 7/16"
81737	7mm Long Pattern Combination Wrench	80123	1/4" Drive 6 Point Deep SAE Socket 1/2"
81665	8mm Long Pattern Combination Wrench	80124	1/4" Drive 6 Point Deep SAE Socket 9/16"
81666	9mm Long Pattern Combination Wrench	80125	1/4" Drive 6 Point Standard Metric Socket 4mm
81667	10mm Long Pattern Combination Wrench	80126	1/4" Drive 6 Point Standard Metric Socket 5mm
81668	11mm Long Pattern Combination Wrench	80127	1/4" Drive 6 Point Standard Metric Socket 5.5mm
81669	12mm Long Pattern Combination Wrench	80128	1/4" Drive 6 Point Standard Metric Socket 6mm

Catalog No.	Description	Catalog No.	Description
80129	1/4" Drive 6 Point Standard Metric Socket 7mm	80387	3/8" Drive 6 Point Standard Metric Socket 19mm
80130	1/4" Drive 6 Point Standard Metric Socket 8mm	80330	3/8" Drive 6 Point Standard Metric Socket 20mm
80131D	1/4" Drive 6 Point Standard Metric Socket 9mm	80331	3/8" Drive 6 Point Standard Metric Socket 21mm
80132	1/4" Drive 6 Point Standard Metric Socket 10mm	80332	3/8" Drive 6 Point Standard Metric Socket 22mm
80133	1/4" Drive 6 Point Standard Metric Socket 11mm	80391	3/8" Drive 6 Point Deep Metric Socket 9mm
80134	1/4" Drive 6 Point Standard Metric Socket 12mm	80392	3/8" Drive 6 Point Deep Metric Socket 10mm
80135D	1/4" Drive 6 Point Standard Metric Socket 13mm	80393D	3/8" Drive 6 Point Deep Metric Socket 11mm
80136	1/4" Drive 6 Point Standard Metric Socket 14mm	80394D	3/8" Drive 6 Point Deep Metric Socket 12mm
80137	1/4" Drive 6 Point Standard Metric Socket 15mm	80395	3/8" Drive 6 Point Deep Metric Socket 13mm
80138	1/4" Drive 6 Point Deep Metric Socket 4mm	80396	3/8" Drive 6 Point Deep Metric Socket 14mm
80139	1/4" Drive 6 Point Deep Metric Socket 5mm	80397	3/8" Drive 6 Point Deep Metric Socket 15mm
80141	1/4" Drive 6 Point Deep Metric Socket 6mm	80398	3/8" Drive 6 Point Deep Metric Socket 16mm
80142	1/4" Drive 6 Point Deep Metric Socket 7mm	80399	3/8" Drive 6 Point Deep Metric Socket 17mm
80143	1/4" Drive 6 Point Deep Metric Socket 8mm	80400	3/8" Drive 6 Point Deep Metric Socket 18mm
80144	1/4" Drive 6 Point Deep Metric Socket 9mm	80401	3/8" Drive 6 Point Deep Metric Socket 19mm
80145	1/4" Drive 6 Point Deep Metric Socket 10mm	80496	3/8" Drive 12 Point Standard SAE Socket 1/4"
80146D	1/4" Drive 6 Point Deep Metric Socket 11mm	80497D	3/8" Drive 12 Point Standard SAE Socket 5/16"
80147	1/4" Drive 6 Point Deep Metric Socket 12mm	80498	3/8" Drive 12 Point Standard SAE Socket 3/8"
80148	1/4" Drive 6 Point Deep Metric Socket 13mm	80499	3/8" Drive 12 Point Standard SAE Socket 7/16"
80149	1/4" Drive 6 Point Deep Metric Socket 14mm	80500D	3/8" Drive 12 Point Standard SAE Socket 1/2"
80350	3/8" Drive 6 Point Standard SAE Socket 1/4"	80501	3/8" Drive 12 Point Standard SAE Socket 9/16"
80351	3/8" Drive 6 Point Standard SAE Socket 5/16"	80502	3/8" Drive 12 Point Standard SAE Socket 5/8"
80352	3/8" Drive 6 Point Standard SAE Socket 3/8"	80503	3/8" Drive 12 Point Standard SAE Socket 11/16"
80353	3/8" Drive 6 Point Standard SAE Socket 7/16"	80504	3/8" Drive 12 Point Standard SAE Socket 3/4"
80354	3/8" Drive 6 Point Standard SAE Socket 1/2"	80505	3/8" Drive 12 Point Standard SAE Socket 13/16"
80355	3/8" Drive 6 Point Standard SAE Socket 9/16"	80506D	3/8" Drive 12 Point Standard SAE Socket 7/8"
80356	3/8" Drive 6 Point Standard SAE Socket 5/8"	80485	3/8" Drive 12 Point Standard Metric Socket 9mm
80357	3/8" Drive 6 Point Standard SAE Socket 11/16"	80486	3/8" Drive 12 Point Standard Metric Socket 10mm
80358	3/8" Drive 6 Point Standard SAE Socket 3/4"	80487	3/8" Drive 12 Point Standard Metric Socket 11mm
80359	3/8" Drive 6 Point Standard SAE Socket 13/16"	80488	3/8" Drive 12 Point Standard Metric Socket 12mm
80360	3/8" Drive 6 Point Standard SAE Socket 7/8"	80489	3/8" Drive 12 Point Standard Metric Socket 13mm
80365	3/8" Drive 6 Point Deep SAE Socket 3/8"	80490	3/8" Drive 12 Point Standard Metric Socket 14mm
80366	3/8" Drive 6 Point Deep SAE Socket 7/16"	80491	3/8" Drive 12 Point Standard Metric Socket 15mm
80367	3/8" Drive 6 Point Deep SAE Socket 1/2"	80492	3/8" Drive 12 Point Standard Metric Socket 16mm
80368	3/8" Drive 6 Point Deep SAE Socket 9/16"	80493	3/8" Drive 12 Point Standard Metric Socket 17mm
80369	3/8" Drive 6 Point Deep SAE Socket 5/8"	80494	3/8" Drive 12 Point Standard Metric Socket 18mm
80370D	3/8" Drive 6 Point Deep SAE Socket 11/16"	80495	3/8" Drive 12 Point Standard Metric Socket 19mm
80371	3/8" Drive 6 Point Deep SAE Socket 3/4"	80596	3/8" Drive 12 Point Standard Metric Socket 20mm
80377	3/8" Drive 6 Point Standard Metric Socket 9mm	80597	3/8" Drive 12 Point Standard Metric Socket 21mm
80378	3/8" Drive 6 Point Standard Metric Socket 10mm	80598	3/8" Drive 12 Point Standard Metric Socket 22mm
80379	3/8" Drive 6 Point Standard Metric Socket 11mm	80760	1/2" Drive 12 Point Standard SAE Socket 7/16"
80380	3/8" Drive 6 Point Standard Metric Socket 12mm	80761	1/2" Drive 12 Point Standard SAE Socket 1/2"
80381	3/8" Drive 6 Point Standard Metric Socket 13mm	80762	1/2" Drive 12 Point Standard SAE Socket 9/16"
80382	3/8" Drive 6 Point Standard Metric Socket 14mm	80763	1/2" Drive 12 Point Standard SAE Socket 5/8"
80383	3/8" Drive 6 Point Standard Metric Socket 15mm	80764	1/2" Drive 12 Point Standard SAE Socket 11/16"
80384	3/8" Drive 6 Point Standard Metric Socket 16mm	80765	1/2" Drive 12 Point Standard SAE Socket 3/4"
80385	3/8" Drive 6 Point Standard Metric Socket 17mm	80766	1/2" Drive 12 Point Standard SAE Socket 13/16"
80386	3/8" Drive 6 Point Standard Metric Socket 18mm	80767	1/2" Drive 12 Point Standard SAE Socket 7/8"

Contents continued on next page.

MULTIDRIVE

3

RATCHETS / SOCKETS / DRIVE TOOLS / SETS

Catalog No.	Description	Catalog No.	Description
80768	1/2" Drive 12 Point Standard SAE Socket 15/16"	-	#3 Phillips Bit
80769	1/2" Drive 12 Point Standard SAE Socket 1"	-	4mm Slotted Bit
80770	1/2" Drive 12 Point Standard SAE Socket 1-1/16"	-	5mm Slotted Bit
80771	1/2" Drive 12 Point Standard SAE Socket 1-1/8"	-	6mm Slotted Bit
80793	1/2" Drive 12 Point Standard SAE Socket 1-3/16"	-	T-40 Torx® Bit
80794	1/2" Drive 12 Point Standard SAE Socket 1-1/4"	-	T-45 Torx® Bit
80680	1/2" Drive 12 Point Standard SAE Socket 1-1/2"	-	T-50 Torx® Bit
80750	1/2" Drive 12 Point Standard Metric Socket 15mm	-	3/16" Nutdriver Bit
80751	1/2" Drive 12 Point Standard Metric Socket 16mm	-	1/4" Nutdriver Bit
80752	1/2" Drive 12 Point Standard Metric Socket 17mm	-	5/16" Nutdriver Bit
80753	1/2" Drive 12 Point Standard Metric Socket 18mm	-	11/32" Nutdriver Bit
80754	1/2" Drive 12 Point Standard Metric Socket 19mm	-	3/8" Nutdriver Bit
80756	1/2" Drive 12 Point Standard Metric Socket 21mm	-	7/16" Nutdriver Bit
80757	1/2" Drive 12 Point Standard Metric Socket 22mm	-	1/2" Nutdriver Bit
80759	1/2" Drive 12 Point Standard Metric Socket 24mm	-	5mm Nutdriver Bit
80811	1/2" Drive 12 Point Standard Metric Socket 25mm	-	6mm Nutdriver Bit
80812	1/2" Drive 12 Point Standard Metric Socket 27mm	-	7mm Nutdriver Bit
80682	1/2" Drive 12 Point Standard Metric Socket 28mm	-	8mm Nutdriver Bit
80813	1/2" Drive 12 Point Standard Metric Socket 30mm	-	11mm Nutdriver Bit
80814D	1/2" Drive 12 Point Standard Metric Socket 32mm	-	9mm Nutdriver Bit
80402	3/8" Drive Spark Plug Socket 5/8"	-	10mm Nutdriver Bit
80403	3/8" Drive Spark Plug Socket 13/16"		
-	#1 Phillips Bit		
-	#2 Phillips Bit		

GEARWRENCH® 141 Pc. 1/4", 3/8", and 1/2" Drive 6 and 12 Point SAE/Metric Mechanics Tool Set

- Includes Storage Case
- Full Polish Chrome Sockets With Large Hard Stamp Size Markings
- Full Polish Chrome Combination Wrenches Feature Offset Box End and Surface Drive® Technology To Reduce Fastener Rounding
- 45 Tooth Full Polish Chrome Quick-Release Ratchets
- The Original ALLEN® Brand Hex Keys
- Knurled Full Polish Chrome Extensions
- Magnetic Bit Driver With Ergonomic Dual Material Handle
- Sockets Feature Surface Drive® Technology To Reduce Fastener Rounding
- Meets or Exceeds ASME B107.1, B107.5M, B107.10, B107.6



Cat. No.	UPC No.	Packaging	Product Weight
80931	099575809316	Boxed	20.33 lb

Catalog No.	Description	Catalog No.	Description
81014	1/4" Drive Teardrop Quick Release Ratchet	80122D	1/4" Drive 6 Point Deep SAE Socket 7/16"
81218	3/8" Drive Teardrop Quick Release Ratchet	80123	1/4" Drive 6 Point Deep SAE Socket 1/2"
81309	1/2" Drive Quick Release Tear Drop Ratchet	80125	1/4" Drive 6 Point Standard Metric Socket 4mm
56603G	13 Piece Long Arm SAE Hex Key Set	80126	1/4" Drive 6 Point Standard Metric Socket 5mm
80480	1/4" Bit Adapter 1/4" Drive	80127	1/4" Drive 6 Point Standard Metric Socket 5.5mm
81799	3/8" x 7/16" Full Polish Open End Wrench	80128	1/4" Drive 6 Point Standard Metric Socket 6mm
81801	1/2" x 9/16" Full Polish Open End Wrench	80129	1/4" Drive 6 Point Standard Metric Socket 7mm
81794D	10 x 12mm Full Polish Open End Wrench	80130	1/4" Drive 6 Point Standard Metric Socket 8mm
81796	12 x 14mm Full Polish Open End Wrench	80131D	1/4" Drive 6 Point Standard Metric Socket 9mm
81113D	1/4" Drive Standard Extension 3"	80132	1/4" Drive 6 Point Standard Metric Socket 10mm
81242	3/8" Drive Standard Extension 6"	80133	1/4" Drive 6 Point Standard Metric Socket 11mm
81340	1/2" Drive Standard Extension 3"	80134	1/4" Drive 6 Point Standard Metric Socket 12mm
80104D	1/4" Drive 6 Point Standard SAE Socket 5/32"	80135D	1/4" Drive 6 Point Standard Metric Socket 13mm
80105	1/4" Drive 6 Point Standard SAE Socket 3/16"	80142	1/4" Drive 6 Point Deep Metric Socket 7mm
80106	1/4" Drive 6 Point Standard SAE Socket 7/32"	80143	1/4" Drive 6 Point Deep Metric Socket 8mm
80107	1/4" Drive 6 Point Standard SAE Socket 1/4"	80144	1/4" Drive 6 Point Deep Metric Socket 9mm
80108	1/4" Drive 6 Point Standard SAE Socket 9/32"	80145	1/4" Drive 6 Point Deep Metric Socket 10mm
80109	1/4" Drive 6 Point Standard SAE Socket 5/16"	80146D	1/4" Drive 6 Point Deep Metric Socket 11mm
80110	1/4" Drive 6 Point Standard SAE Socket 11/32"	80147	1/4" Drive 6 Point Deep Metric Socket 12mm
80111	1/4" Drive 6 Point Standard SAE Socket 3/8"	80148	1/4" Drive 6 Point Deep Metric Socket 13mm
80112	1/4" Drive 6 Point Standard SAE Socket 7/16"	80352	3/8" Drive 6 Point Standard SAE Socket 3/8"
80113D	1/4" Drive 6 Point Standard SAE Socket 1/2"	80353	3/8" Drive 6 Point Standard SAE Socket 7/16"
80117	1/4" Drive 6 Point Deep SAE Socket 1/4"	80354	3/8" Drive 6 Point Standard SAE Socket 1/2"
80118	1/4" Drive 6 Point Deep SAE Socket 9/32"	80355	3/8" Drive 6 Point Standard SAE Socket 9/16"
80119	1/4" Drive 6 Point Deep SAE Socket 5/16"	80356	3/8" Drive 6 Point Standard SAE Socket 5/8"
80120D	1/4" Drive 6 Point Deep SAE Socket 11/32"	80357	3/8" Drive 6 Point Standard SAE Socket 11/16"
80121	1/4" Drive 6 Point Deep SAE Socket 3/8"	80358	3/8" Drive 6 Point Standard SAE Socket 3/4"

Contents continued on next page.

MULTIDRIVE

3

RATCHETS / SOCKETS / DRIVE TOOLS / SETS

Catalog No.	Description	Catalog No.	Description
80365	3/8" Drive 6 Point Deep SAE Socket 3/8"	80495	3/8" Drive 12 Point Standard Metric Socket 19mm
80366	3/8" Drive 6 Point Deep SAE Socket 7/16"	80764	1/2" Drive 12 Point Standard SAE Socket 11/16"
80367	3/8" Drive 6 Point Deep SAE Socket 1/2"	80765	1/2" Drive 12 Point Standard SAE Socket 3/4"
80368	3/8" Drive 6 Point Deep SAE Socket 9/16"	80766	1/2" Drive 12 Point Standard SAE Socket 13/16"
80369	3/8" Drive 6 Point Deep SAE Socket 5/8"	80767	1/2" Drive 12 Point Standard SAE Socket 7/8"
80370D	3/8" Drive 6 Point Deep SAE Socket 11/16"	80768	1/2" Drive 12 Point Standard SAE Socket 15/16"
80371	3/8" Drive 6 Point Deep SAE Socket 3/4"	80769	1/2" Drive 12 Point Standard SAE Socket 1"
80378	3/8" Drive 6 Point Standard Metric Socket 10mm	80750	1/2" Drive 12 Point Standard Metric Socket 15mm
80379	3/8" Drive 6 Point Standard Metric Socket 11mm	80751	1/2" Drive 12 Point Standard Metric Socket 16mm
80380	3/8" Drive 6 Point Standard Metric Socket 12mm	80752	1/2" Drive 12 Point Standard Metric Socket 17mm
80381	3/8" Drive 6 Point Standard Metric Socket 13mm	80753	1/2" Drive 12 Point Standard Metric Socket 18mm
80382	3/8" Drive 6 Point Standard Metric Socket 14mm	80754	1/2" Drive 12 Point Standard Metric Socket 19mm
80383	3/8" Drive 6 Point Standard Metric Socket 15mm	80756	1/2" Drive 12 Point Standard Metric Socket 21mm
80384	3/8" Drive 6 Point Standard Metric Socket 16mm	80402	3/8" Drive Spark Plug Socket 5/8"
80385	3/8" Drive 6 Point Standard Metric Socket 17mm	-	#1 Phillips Bit
80386	3/8" Drive 6 Point Standard Metric Socket 18mm	-	#2 Phillips Bit
80387	3/8" Drive 6 Point Standard Metric Socket 19mm	-	#3 Phillips Bit
80392	3/8" Drive 6 Point Deep Metric Socket 10mm	-	4mm Slotted Bit
80393D	3/8" Drive 6 Point Deep Metric Socket 11mm	-	5mm Slotted Bit
80394D	3/8" Drive 6 Point Deep Metric Socket 12mm	-	6mm Slotted Bit
80395	3/8" Drive 6 Point Deep Metric Socket 13mm	-	T-40 Torx® Bit
80396	3/8" Drive 6 Point Deep Metric Socket 14mm	-	T-45 Torx® Bit
80397	3/8" Drive 6 Point Deep Metric Socket 15mm	-	T-50 Torx® Bit
80398	3/8" Drive 6 Point Deep Metric Socket 16mm	-	3/16" Nutdriver Bit
80399	3/8" Drive 6 Point Deep Metric Socket 17mm	-	1/4" Nutdriver Bit
80400	3/8" Drive 6 Point Deep Metric Socket 18mm	-	5/16" Nutdriver Bit
80401	3/8" Drive 6 Point Deep Metric Socket 19mm	-	11/32" Nutdriver Bit
80498	3/8" Drive 12 Point Standard SAE Socket 3/8"	-	3/8" Nutdriver Bit
80499	3/8" Drive 12 Point Standard SAE Socket 7/16"	-	7/16" Nutdriver Bit
80500D	3/8" Drive 12 Point Standard SAE Socket 1/2"	-	1/2" Nutdriver Bit
80501	3/8" Drive 12 Point Standard SAE Socket 9/16"	-	5mm Nutdriver Bit
80502	3/8" Drive 12 Point Standard SAE Socket 5/8"	-	6mm Nutdriver Bit
80503	3/8" Drive 12 Point Standard SAE Socket 11/16"	-	7mm Nutdriver Bit
80504	3/8" Drive 12 Point Standard SAE Socket 3/4"	-	8mm Nutdriver Bit
80489	3/8" Drive 12 Point Standard Metric Socket 13mm	-	11mm Nutdriver Bit
80490	3/8" Drive 12 Point Standard Metric Socket 14mm	-	9mm Nutdriver Bit
80491	3/8" Drive 12 Point Standard Metric Socket 15mm	-	10mm Nutdriver Bit
80492	3/8" Drive 12 Point Standard Metric Socket 16mm		
80493	3/8" Drive 12 Point Standard Metric Socket 17mm		
80494	3/8" Drive 12 Point Standard Metric Socket 18mm		

GEARWRENCH® 118 Pc. 1/4", 3/8", and 1/2" Drive 6 and 12 Point SAE/Metric Mechanics Tool Set

- Includes Storage Case
- Full Polish Chrome Sockets With Large Hard Stamp Size Markings
- 84 Tooth Full Polish Chrome Thin Profile Ratchets
- Knurled Full Polish Chrome Extensions
- Magnetic 1/4 Bit Driver With Ergonomic Dual Material Handle
- Sockets Feature Surface Drive® Technology To Reduce Fastener Rounding
- Meets or Exceeds ASME B107.1, B107.5M, B107.10, B107.6



Cat. No.	UPC No.	Packaging	Product Weight
83001D	099575830013	Boxed	18.72 lb

Catalog No.	Description	Catalog No.	Description
81011F	1/4" Drive Full Polish Teardrop Ratchet	80109	1/4" Drive 6 Point Standard SAE Socket 5/16"
81211F	3/8" Drive Full Polish Teardrop Ratchet	80110	1/4" Drive 6 Point Standard SAE Socket 11/32"
81304F	1/2" Drive Full Polish Teardrop Ratchet	80111	1/4" Drive 6 Point Standard SAE Socket 3/8"
80480	1/4" Bit Adapter 1/4" Drive	80112	1/4" Drive 6 Point Standard SAE Socket 7/16"
81128	1/4" Socket Driver	80113D	1/4" Drive 6 Point Standard SAE Socket 1/2"
80471	Insert Bit T-10 Tamper Proof Torx® Bit	80114D	1/4" Drive 6 Point Standard SAE Socket 9/16"
80472	Insert Bit T-15 Tamper Proof Torx® Bit	80117	1/4" Drive 6 Point Deep SAE Socket 1/4"
80473	Insert Bit T-20 Tamper Proof Torx® Bit	80118	1/4" Drive 6 Point Deep SAE Socket 9/32"
80474	Insert Bit T-25 Tamper Proof Torx® Bit	80119	1/4" Drive 6 Point Deep SAE Socket 5/16"
80475	Insert Bit T-27 Tamper Proof Torx® Bit	80120D	1/4" Drive 6 Point Deep SAE Socket 11/32"
80476	Insert Bit T-30 Tamper Proof Torx® Bit	80121	1/4" Drive 6 Point Deep SAE Socket 3/8"
80180	1/4" Drive TORX® Tamper-Proof Bit Socket, T-10	80122D	1/4" Drive 6 Point Deep SAE Socket 7/16"
80181	1/4" Drive TORX® Tamper-Proof Bit Socket, T-15	80123	1/4" Drive 6 Point Deep SAE Socket 1/2"
80182	1/4" Drive TORX® Tamper-Proof Bit Socket, T-20	80125	1/4" Drive 6 Point Standard Metric Socket 4mm
80178	1/4" Drive TORX® Tamper-Proof Bit Socket, T-7	80126	1/4" Drive 6 Point Standard Metric Socket 5mm
80179	1/4" Drive TORX® Tamper-Proof Bit Socket, T-8	80128	1/4" Drive 6 Point Standard Metric Socket 6mm
81119	1/4" Drive Wobble Extension 2"	80129	1/4" Drive 6 Point Standard Metric Socket 7mm
81241	3/8" Drive Standard Extension 3"	80130	1/4" Drive 6 Point Standard Metric Socket 8mm
81242	3/8" Drive Standard Extension 6"	80131D	1/4" Drive 6 Point Standard Metric Socket 9mm
81345	1/2" Drive Wobble Extension 5"	80132	1/4" Drive 6 Point Standard Metric Socket 10mm
81655	7/16" Long Pattern Combination Wrench	80133	1/4" Drive 6 Point Standard Metric Socket 11mm
81656	1/2" Long Pattern Combination Wrench	80134	1/4" Drive 6 Point Standard Metric Socket 12mm
81657	9/16" Long Pattern Combination Wrench	80135D	1/4" Drive 6 Point Standard Metric Socket 13mm
81675	18mm Long Pattern Combination Wrench	80142	1/4" Drive 6 Point Deep Metric Socket 7mm
81676	19mm Long Pattern Combination Wrench	80143	1/4" Drive 6 Point Deep Metric Socket 8mm
80105	1/4" Drive 6 Point Standard SAE Socket 3/16"	80144	1/4" Drive 6 Point Deep Metric Socket 9mm
80106	1/4" Drive 6 Point Standard SAE Socket 7/32"	80145	1/4" Drive 6 Point Deep Metric Socket 10mm
80107	1/4" Drive 6 Point Standard SAE Socket 1/4"	80146D	1/4" Drive 6 Point Deep Metric Socket 11mm
80108	1/4" Drive 6 Point Standard SAE Socket 9/32"	80147	1/4" Drive 6 Point Deep Metric Socket 12mm

Contents continued on next page.

MULTIDRIVE

3

RATCHETS / SOCKETS / DRIVE TOOLS / SETS

Catalog No.	Description	Catalog No.	Description
80148	1/4" Drive 6 Point Deep Metric Socket 13mm	80502	3/8" Drive 12 Point Standard SAE Socket 5/8"
80210	1/4" Drive 12 Point Standard SAE Socket 3/16"	80503	3/8" Drive 12 Point Standard SAE Socket 11/16"
80211	1/4" Drive 12 Point Standard SAE Socket 7/32"	80504	3/8" Drive 12 Point Standard SAE Socket 3/4"
80212	1/4" Drive 12 Point Standard SAE Socket 1/4"	80505	3/8" Drive 12 Point Standard SAE Socket 13/16"
80213	1/4" Drive 12 Point Standard SAE Socket 9/32"	80510D	3/8 Drive 12 Point Deep SAE Socket 5/16"
80214	1/4" Drive 12 Point Standard SAE Socket 5/16"	80511	3/8 Drive 12 Point Deep SAE Socket 3/8"
80215D	1/4" Drive 12 Point Standard SAE Socket 11/32"	80512	3/8 Drive 12 Point Deep SAE Socket 7/16"
80216	1/4" Drive 12 Point Standard SAE Socket 3/8"	80513	3/8 Drive 12 Point Deep SAE Socket 1/2"
80217	1/4" Drive 12 Point Standard SAE Socket 7/16"	80514	3/8 Drive 12 Point Deep SAE Socket 9/16"
80218	1/4" Drive 12 Point Standard SAE Socket 1/2"	80515D	3/8 Drive 12 Point Deep SAE Socket 5/8"
80377	3/8" Drive 6 Point Standard Metric Socket 9mm	80516	3/8 Drive 12 Point Deep SAE Socket 11/16"
80378	3/8" Drive 6 Point Standard Metric Socket 10mm	80485	3/8" Drive 12 Point Standard Metric Socket 9mm
80379	3/8" Drive 6 Point Standard Metric Socket 11mm	80486	3/8" Drive 12 Point Standard Metric Socket 10mm
80380	3/8" Drive 6 Point Standard Metric Socket 12mm	80487	3/8" Drive 12 Point Standard Metric Socket 11mm
80381	3/8" Drive 6 Point Standard Metric Socket 13mm	80488	3/8" Drive 12 Point Standard Metric Socket 12mm
80382	3/8" Drive 6 Point Standard Metric Socket 14mm	80489	3/8" Drive 12 Point Standard Metric Socket 13mm
80383	3/8" Drive 6 Point Standard Metric Socket 15mm	80490	3/8" Drive 12 Point Standard Metric Socket 14mm
80385	3/8" Drive 6 Point Standard Metric Socket 17mm	80491	3/8" Drive 12 Point Standard Metric Socket 15mm
80387	3/8" Drive 6 Point Standard Metric Socket 19mm	80492	3/8" Drive 12 Point Standard Metric Socket 16mm
80392	3/8" Drive 6 Point Deep Metric Socket 10mm	80493	3/8" Drive 12 Point Standard Metric Socket 17mm
80394D	3/8" Drive 6 Point Deep Metric Socket 12mm	80494	3/8" Drive 12 Point Standard Metric Socket 18mm
80395	3/8" Drive 6 Point Deep Metric Socket 13mm	80495	3/8" Drive 12 Point Standard Metric Socket 19mm
80396	3/8" Drive 6 Point Deep Metric Socket 14mm	80772	1/2" Drive 12 Point Deep SAE Socket 7/16"
80397	3/8" Drive 6 Point Deep Metric Socket 15mm	80773	1/2" Drive 12 Point Deep SAE Socket 1/2"
80398	3/8" Drive 6 Point Deep Metric Socket 16mm	80774	1/2" Drive 12 Point Deep SAE Socket 9/16"
80399	3/8" Drive 6 Point Deep Metric Socket 17mm	80775	1/2" Drive 12 Point Deep SAE Socket 5/8"
80498	3/8" Drive 12 Point Standard SAE Socket 3/8"	80776	1/2" Drive 12 Point Deep SAE Socket 11/16"
80499	3/8" Drive 12 Point Standard SAE Socket 7/16"	80777D	1/2" Drive 12 Point Deep SAE Socket 3/4"
80500D	3/8" Drive 12 Point Standard SAE Socket 1/2"	80778	1/2" Drive 12 Point Deep SAE Socket 13/16"
80501	3/8" Drive 12 Point Standard SAE Socket 9/16"	80402	3/8" Drive Spark Plug Socket 5/8"

GEARWRENCH® 88 Pc. 1/4" and 3/8" Drive 6 and 12 Point SAE/Metric Mechanics Tool Set

- Includes Storage Case
- Full Polish Chrome Sockets With Large Hard Stamp Size Markings
- Full Polish Chrome Double Open End Wrenches Surface Drive® Technology To Reduce Fastener Rounding
- 45 Tooth Full Polish Chrome Quick-Release Ratchets
- The Original ALLEN® Brand Hex Keys
- Knurled Full Polish Chrome Extension
- Magnetic Bit Driver With Ergonomic Dual Material Handle
- Sockets Feature Surface Drive® Technology To Reduce Fastener Rounding
- Meets or Exceeds ASME B107.1, B107.5M, B107.10, B107.6



Cat. No.	UPC No.	Packaging	Product Weight
80930	099575809309	Boxed	8.91 lb

Cat. No.	Description	Cat. No.	Description
81218	3/8" Drive Teardrop Quick Release Ratchet	80135D	1/4" Drive 6 Point Standard Metric Socket 13mm
56603G	13 Piece Long Arm SAE Hex Key Set	80136	1/4" Drive 6 Point Standard Metric Socket 14mm
80480	1/4" Bit Adapter 1/4" Drive	80496	3/8" Drive 12 Point Standard SAE Socket 1/4"
81128	1/4" Socket Driver	80497D	3/8" Drive 12 Point Standard SAE Socket 5/16"
81277	3/8" Drive 3/8" F x 1/4" M Adapter	80498	3/8" Drive 12 Point Standard SAE Socket 3/8"
81799	3/8" x 7/16" Full Polish Open End Wrench	80499	3/8" Drive 12 Point Standard SAE Socket 7/16"
81801	1/2" x 9/16" Full Polish Open End Wrench	80500D	3/8" Drive 12 Point Standard SAE Socket 1/2"
81794D	10 x 12mm Full Polish Open End Wrench	80501	3/8" Drive 12 Point Standard SAE Socket 9/16"
81796	12 x 14mm Full Polish Open End Wrench	80502	3/8" Drive 12 Point Standard SAE Socket 5/8"
81241	3/8" Drive Standard Extension 3"	80503	3/8" Drive 12 Point Standard SAE Socket 11/16"
80104D	1/4" Drive 6 Point Standard SAE Socket 5/32"	80504	3/8" Drive 12 Point Standard SAE Socket 3/4"
80105	1/4" Drive 6 Point Standard SAE Socket 3/16"	80505	3/8" Drive 12 Point Standard SAE Socket 13/16"
80106	1/4" Drive 6 Point Standard SAE Socket 7/32"	80506D	3/8" Drive 12 Point Standard SAE Socket 7/8"
80107	1/4" Drive 6 Point Standard SAE Socket 1/4"	80485	3/8" Drive 12 Point Standard Metric Socket 9mm
80108	1/4" Drive 6 Point Standard SAE Socket 9/32"	80486	3/8" Drive 12 Point Standard Metric Socket 10mm
80109	1/4" Drive 6 Point Standard SAE Socket 5/16"	80487	3/8" Drive 12 Point Standard Metric Socket 11mm
80110	1/4" Drive 6 Point Standard SAE Socket 11/32"	80488	3/8" Drive 12 Point Standard Metric Socket 12mm
80111	1/4" Drive 6 Point Standard SAE Socket 3/8"	80489	3/8" Drive 12 Point Standard Metric Socket 13mm
80112	1/4" Drive 6 Point Standard SAE Socket 7/16"	80490	3/8" Drive 12 Point Standard Metric Socket 14mm
80113D	1/4" Drive 6 Point Standard SAE Socket 1/2"	80491	3/8" Drive 12 Point Standard Metric Socket 15mm
80114D	1/4" Drive 6 Point Standard SAE Socket 9/16"	80492	3/8" Drive 12 Point Standard Metric Socket 16mm
80125	1/4" Drive 6 Point Standard Metric Socket 4mm	80493	3/8" Drive 12 Point Standard Metric Socket 17mm
80126	1/4" Drive 6 Point Standard Metric Socket 5mm	80494	3/8" Drive 12 Point Standard Metric Socket 18mm
80127	1/4" Drive 6 Point Standard Metric Socket 5.5mm	80495	3/8" Drive 12 Point Standard Metric Socket 19mm
80128	1/4" Drive 6 Point Standard Metric Socket 6mm	80402	3/8" Drive Spark Plug Socket 5/8"
80129	1/4" Drive 6 Point Standard Metric Socket 7mm	-	#1 Phillips Bit
80130	1/4" Drive 6 Point Standard Metric Socket 8mm	-	#2 Phillips Bit
80131D	1/4" Drive 6 Point Standard Metric Socket 9mm	-	#3 Phillips Bit
80132	1/4" Drive 6 Point Standard Metric Socket 10mm	-	4mm Slotted Bit
80133	1/4" Drive 6 Point Standard Metric Socket 11mm	-	5mm Slotted Bit
80134	1/4" Drive 6 Point Standard Metric Socket 12mm	-	6mm Nutdriver Bit

MULTIDRIVE

3

RATCHETS / SOCKETS / DRIVE TOOLS / SETS

GEARWRENCH® 68 Pc. 1/4" and 3/8" Drive 6 and 12 Point SAE/Metric Mechanics Tool Set

- Includes Storage Case
- Full Polish Chrome Sockets With Large Hard Stamp Size Markings
- 84 Tooth Full Polish Chrome Thin Profile Ratchets
- Knurled Full Polish Chrome Extensions
- Meets or Exceeds ASME B107.1, B107.5M, B107.10



Cat. No.	UPC No.	Packaging	Product Weight
83000	099575830006	Boxed	9.90 lb

Cat. No.	Description	Cat. No.	Description
81011F	1/4" Drive Full Polish Teardrop Ratchet	80198	1/4" Drive 12 Point Standard Socket 5mm
81211F	3/8" Drive Full Polish Teardrop Ratchet	80200	1/4" Drive 12 Point Standard Socket 6mm
81101	1/4" Drive Standard Extension 2"	80201	1/4" Drive 12 Point Standard Socket 7mm
81116	1/4" Drive Standard Extension 6"	80202	1/4" Drive 12 Point Standard Socket 8mm
81241	3/8" Drive Standard Extension 3"	80203	1/4" Drive 12 Point Standard Socket 9mm
81242	3/8" Drive Standard Extension 6"	80204	1/4" Drive 12 Point Standard Socket 10mm
80115	1/4" Drive 6 Point Deep SAE Socket 3/16"	80205	1/4" Drive 12 Point Standard Socket 11mm
80116D	1/4" Drive 6 Point Deep SAE Socket 7/32"	80206	1/4" Drive 12 Point Standard Socket 12mm
80117	1/4" Drive 6 Point Deep SAE Socket 1/4"	80365	3/8" Drive 6 Point Deep SAE Socket 3/8"
80118	1/4" Drive 6 Point Deep SAE Socket 9/32"	80366	3/8" Drive 6 Point Deep SAE Socket 7/16"
80119	1/4" Drive 6 Point Deep SAE Socket 5/16"	80367	3/8" Drive 6 Point Deep SAE Socket 1/2"
80120D	1/4" Drive 6 Point Deep SAE Socket 11/32"	80368	3/8" Drive 6 Point Deep SAE Socket 9/16"
80121	1/4" Drive 6 Point Deep SAE Socket 3/8"	80369	3/8" Drive 6 Point Deep SAE Socket 5/8"
80122D	1/4" Drive 6 Point Deep SAE Socket 7/16"	80370D	3/8" Drive 6 Point Deep SAE Socket 11/16"
80123	1/4" Drive 6 Point Deep SAE Socket 1/2"	80371	3/8" Drive 6 Point Deep SAE Socket 3/4"
80141	1/4" Drive 6 Point Deep Metric Socket 6mm	80372	3/8" Drive 6 Point Deep SAE Socket 13/16"
80142	1/4" Drive 6 Point Deep Metric Socket 7mm	80498	3/8" Drive 12 Point Standard SAE Socket 3/8"
80143	1/4" Drive 6 Point Deep Metric Socket 8mm	80499	3/8" Drive 12 Point Standard SAE Socket 7/16"
80144	1/4" Drive 6 Point Deep Metric Socket 9mm	80500D	3/8" Drive 12 Point Standard SAE Socket 1/2"
80145	1/4" Drive 6 Point Deep Metric Socket 10mm	80501	3/8" Drive 12 Point Standard SAE Socket 9/16"
80146D	1/4" Drive 6 Point Deep Metric Socket 11mm	80502	3/8" Drive 12 Point Standard SAE Socket 5/8"
80147	1/4" Drive 6 Point Deep Metric Socket 12mm	80503	3/8" Drive 12 Point Standard SAE Socket 11/16"
80148	1/4" Drive 6 Point Deep Metric Socket 13mm	80504	3/8" Drive 12 Point Standard SAE Socket 3/4"
80149	1/4" Drive 6 Point Deep Metric Socket 14mm	80505	3/8" Drive 12 Point Standard SAE Socket 13/16"
80210	1/4" Drive 12 Point Standard SAE Socket 3/16"	80506D	3/8" Drive 12 Point Standard SAE Socket 7/8"
80211	1/4" Drive 12 Point Standard SAE Socket 7/32"	80485	3/8" Drive 12 Point Standard Metric Socket 9mm
80212	1/4" Drive 12 Point Standard SAE Socket 1/4"	80486	3/8" Drive 12 Point Standard Metric Socket 10mm
80213	1/4" Drive 12 Point Standard SAE Socket 9/32"	80487	3/8" Drive 12 Point Standard Metric Socket 11mm
80214	1/4" Drive 12 Point Standard SAE Socket 5/16"	80488	3/8" Drive 12 Point Standard Metric Socket 12mm
80215D	1/4" Drive 12 Point Standard SAE Socket 11/32"	80489	3/8" Drive 12 Point Standard Metric Socket 13mm
80216	1/4" Drive 12 Point Standard SAE Socket 3/8"	80490	3/8" Drive 12 Point Standard Metric Socket 14mm
80217	1/4" Drive 12 Point Standard SAE Socket 7/16"	80491	3/8" Drive 12 Point Standard Metric Socket 15mm
80218	1/4" Drive 12 Point Standard SAE Socket 1/2"	80492	3/8" Drive 12 Point Standard Metric Socket 16mm
80197	1/4" Drive 12 Point Standard Socket 4mm	80493	3/8" Drive 12 Point Standard Metric Socket 17mm

MULTIDRIVE

3

RATCHETS / SOCKETS / DRIVE TOOLS / SETS

GEARWRENCH® 39 Pc. 1/4" and 3/8" Drive 6 and 12 Point SAE/Metric Mechanics Tool Set

- Includes Storage Case
- Full Polish Chrome Sockets With Large Hard Stamp Size Markings
- 45 Tooth Full Polish Chrome Quick-Release Ratchet
- Knurled Full Polish Chrome Extensions
- Sockets Feature Surface Drive® Technology To Reduce Fastener Rounding
- Meets or Exceeds ASME B107.1, B107.5M, B107.10



Cat. No.	UPC No.	Packaging	Product Weight
80929	099575809293	Boxed	3.70 lb

Cat. No.	Description	Cat. No.	Description
81218	3/8" Drive Teardrop Quick Release Ratchet	80131D	1/4" Drive 6 Point Standard Metric Socket 9mm
81277	3/8" Drive 3/8" F x 1/4" M Adapter	80132	1/4" Drive 6 Point Standard Metric Socket 10mm
81241	3/8" Drive Standard Extension 3"	80350	3/8" Drive 6 Point Standard SAE Socket 1/4"
80104D	1/4" Drive 6 Point Standard SAE Socket 5/32"	80351	3/8" Drive 6 Point Standard SAE Socket 5/16"
80105	1/4" Drive 6 Point Standard SAE Socket 3/16"	80352	3/8" Drive 6 Point Standard SAE Socket 3/8"
80106	1/4" Drive 6 Point Standard SAE Socket 7/32"	80353	3/8" Drive 6 Point Standard SAE Socket 7/16"
80107	1/4" Drive 6 Point Standard SAE Socket 1/4"	80354	3/8" Drive 6 Point Standard SAE Socket 1/2"
80108	1/4" Drive 6 Point Standard SAE Socket 9/32"	80355	3/8" Drive 6 Point Standard SAE Socket 9/16"
80109	1/4" Drive 6 Point Standard SAE Socket 5/16"	80356	3/8" Drive 6 Point Standard SAE Socket 5/8"
80110	1/4" Drive 6 Point Standard SAE Socket 11/32"	80357	3/8" Drive 6 Point Standard SAE Socket 11/16"
80111	1/4" Drive 6 Point Standard SAE Socket 3/8"	80358	3/8" Drive 6 Point Standard SAE Socket 3/4"
80112	1/4" Drive 6 Point Standard SAE Socket 7/16"	80377	3/8" Drive 6 Point Standard Metric Socket 9mm
80113D	1/4" Drive 6 Point Standard SAE Socket 1/2"	80378	3/8" Drive 6 Point Standard Metric Socket 10mm
80114D	1/4" Drive 6 Point Standard SAE Socket 9/16"	80379	3/8" Drive 6 Point Standard Metric Socket 11mm
80125	1/4" Drive 6 Point Standard Metric Socket 4mm	80380	3/8" Drive 6 Point Standard Metric Socket 12mm
80126	1/4" Drive 6 Point Standard Metric Socket 5mm	80381	3/8" Drive 6 Point Standard Metric Socket 13mm
80127	1/4" Drive 6 Point Standard Metric Socket 5.5mm	80382	3/8" Drive 6 Point Standard Metric Socket 14mm
80128	1/4" Drive 6 Point Standard Metric Socket 6mm	80383	3/8" Drive 6 Point Standard Metric Socket 15mm
80129	1/4" Drive 6 Point Standard Metric Socket 7mm	80402	3/8" Drive Spark Plug Socket 5/8"
80130	1/4" Drive 6 Point Standard Metric Socket 8mm		

MULTIDRIVE

3

RATCHETS / SOCKETS / DRIVE TOOLS / SETS

GEARWRENCH® 4 Pc. 1/4", 3/8", and 1/2" Drive Full Polish Flex Handle Ratchet Set

- 84 Tooth Gear gives a 4.3° swing arc for easy access
- Flush Mounted On-Off Lever
- Teardrop Shaped Head
- Full Polish Chrome Handle
- Bright Chrome Finish
- Meets or Exceeds ASME B107.10



Cat. No.	UPC No.	Packaging	Tooth Count	Product Weight
81230F	099575800023	Tray	84	3.121 lb

Cat. No.	Description	Cat. No.	Description
81012F	1/4" Drive Full Polish Flex Head Ratchet	81215F	3/8" Drive Full Polish Flex Head Ratchet
81212F	3/8" Drive Stubby Flex Head Ratchet - Full Polish	81306F	1/2" Drive Full Polish Flex Head Ratchet

GEARWRENCH® 2 Pc. 1/4" and 3/8" Drive Full Polish Flex Handle Ratchet Set

- 84 Tooth Gear gives a 4.3° swing arc for easy access
- Flush Mounted On-Off Lever
- Teardrop Shaped Head
- Full Polish Chrome Handle
- Bright Chrome Finish
- Meets or Exceeds ASME B107.10



Cat. No.	UPC No.	Packaging	Tooth Count	Product Weight
81216F	099575861116	Tray	84	2.184 lb

Cat. No.	Description	Cat. No.	Description
81012F	1/4" Drive Full Polish Flex Head Ratchet	81215F	3/8" Drive Full Polish Flex Head Ratchet

GEARWRENCH® 3 Pc. 1/4", 3/8", and 1/2" Drive Full Polish Teardrop Ratchet Set

- 84 Tooth Gear gives a 4.3° swing arc for easy access
- Flush Mounted On-Off Lever
- Teardrop Shaped Head
- Full Polish Chrome Handle
- Bright Chrome Finish
- Meets or Exceeds ASME B107.10



Cat. No.	UPC No.	Packaging	Tooth Count	Product Weight
81206F	099575811067	Tray	84	2.646 lb

Cat. No.	Description	Cat. No.	Description
81011F	1/4" Drive Full Polish Teardrop Ratchet	81304F	1/2" Drive Full Polish Teardrop Ratchet
81211F	3/8" Drive Full Polish Teardrop Ratchet		

GEARWRENCH® 2 Pc. 1/4" and 3/8" Drive Full Polish Long Handle Teardrop Ratchet Set

- 84 Tooth Gear Gives 4.3° Swing Arc for Easy Access
- Full Polish Chrome, Long Handle for Increased Access
- Flush Mounted On-Off Lever
- Teardrop Shaped Head
- Full Polish Chrome Finish
- Meets or Exceeds ASME B107.10



Cat. No.	UPC No.	Packaging	Tooth Count	Product Weight
81268	099575812682	Tray	84	1.34 lb

Cat. No.	Description	Cat. No.	Description
81028	1/4" Drive Long Handle Full Polish Teardrop Ratchet	81264	3/8" Drive Long Handle Full Polish Teardrop Ratchet

GEARWRENCH® 4 Pc. 1/4", 3/8", and 1/2" Drive 120XP™ Full Polish Flex Handle Ratchet Set



- 120 Positions, 3° Ratcheting Arc
- The Gear is Alternately Engaged by the Double-Stacked Pawls which give a 3° Swing Arc for Faster Work
- 6-Position Flex Head for Adjustable Access Angle
- Highly Visible On/Off Markings on the Head
- Enclosed Head Design for Extreme Resistance to Dirt Infiltration
- Double-Stacked Pawls Engage a 60-tooth Gear Providing Exceptional Strength, Exceeding ASME Specifications
- Teardrop Low Profile Head and Flush Mounted On/Off Switch Allow Better Access in Tight Spaces
- Longer Reach Handle to Access Hard to Reach Fasteners
- Full Polish Chrome Handle
- Meets or Exceeds ASME B107.10



Cat. No.	UPC No.	Packaging	No. of Positions	Product Weight
81230P	099575012303	Tray	120	4.83 lb

Cat. No.	Description	Cat. No.	Description
81012P	1/4" Drive 120XP™ Full Polish Flex Teardrop Ratchet	81215P	3/8" Drive 120XP™ Full Polish Flex Teardrop Ratchet
81212P	3/8" Drive 120XP Full Polish Teardrop Stubby Flex Head Ratchet	81306P	1/2" Drive 120XP™ Full Polish Teardrop Flex Head Ratchet

GEARWRENCH® 3 Pc. 1/4", 3/8" and 1/2" Drive 120XP™ Full Polish Ratchet Set **120XP**

- 120 Positions, 3° Ratcheting Arc
- The Gear is Alternately Engaged by the Double-Stacked Pawls which give a 3° Swing Arc for Faster Work
- Highly Visible On/Off Markings on the Head
- Enclosed Head Design for Extreme Resistance to Dirt Infiltration
- Double-Stacked Pawls Engage a 60-tooth Gear Providing Exceptional Strength, Exceeding ASME Specifications
- Teardrop Low Profile Head and Flush Mounted On/Off Switch Allow Better Access in Tight Spaces
- Longer Reach Handle to Access Hard to Reach Fasteners
- Full Polish Chrome Handle
- Meets or Exceeds ASME B107.10



Cat. No.	UPC No.	Packaging	No. of Positions	Product Weight
81206P	099575816024	EVA Foam Tray	120	3.20 lb

Cat. No.	Description	Cat. No.	Description
81011P	1/4" Drive 120XP Full Polish Teardrop Ratchet	81304P	1/2" Drive 120XP Full Polish Teardrop Ratchet
81211P	3/8" Drive 120XP Full Polish Teardrop Ratchet		

GEARWRENCH® 3 Pc. 1/4", 3/8", and 1/2" Drive Quick-Release Teardrop Ratchet Set

- Quick-Release Drive Tool Retention
- Teardrop Shaped Head
- Full Polish Chrome Handle
- Bright Chrome Finish
- Meets or Exceeds ASME B107.10



Cat. No.	UPC No.	Packaging	Tooth Count	Product Weight
81310	099575813108	Carded	45	2.73 lb

Cat. No.	Description	Cat. No.	Description
81014	1/4" Drive Teardrop Quick Release Ratchet	81309	1/2" Drive Quick Release Tear Drop Ratchet
81218	3/8" Drive Teardrop Quick Release Ratchet		

GEARWRENCH® 3 Pc. 1/4", 3/8", and 1/2" Drive Cushion Grip Teardrop Ratchet Set

- 84 Tooth Gear gives a 4.3° Swing Arc for Easy Access
- Flush Mounted On-Off Lever
- Teardrop Shaped Head
- Dual Material Cushion Grip Handle
- Bright Chrome Finish
- Meets or Exceeds ASME B107.10



Cat. No.	UPC No.	Packaging	Tooth Count	Product Weight
81207F	099575820700	Carded	84	2.87 lb

Cat. No.	Description	Cat. No.	Description
81007F	1/4" Drive Ratchet w/Cushion Grip	81303F	1/2" Drive Ratchet w/Cushion Grip
81208F	3/8" Drive Ratchet w/Cushion Grip		

GEARWRENCH® 3 Pc. 1/4" and 3/8" Drive Cushion Grip Mixed Teardrop Set

- 84 Tooth Gear gives a 4.3° swing arc for easy access
- Flush Mounted On-Off Lever
- Teardrop Shaped Head
- Dual Material Cushion Grip Handle
- Bright Chrome Finish
- Meets or Exceeds ASME B107.10



Cat. No.	UPC No.	Packaging	Tooth Count	Product Weight
81203F	099575811036	Carded	84	2.22 lb

Cat. No.	Description	Cat. No.	Description
81007F	1/4" Drive Ratchet w/Cushion Grip	81210F	3/8" Drive Flex Ratchet w/Cushion Grip
81208F	3/8" Drive Ratchet w/Cushion Grip		

GEARWRENCH® 2 Pc. 1/4" and 3/8" Drive Cushion Grip Flex Teardrop Set

- 84 Tooth Gear gives a 4.3° swing arc for easy access
- Flush Mounted On-Off Lever
- Teardrop Shaped Head
- Dual Material Cushion Grip Handle
- Bright Chrome Finish
- Meets or Exceeds ASME B107.10



Cat. No.	UPC No.	Packaging	Tooth Count	Product Weight
81204F	099575811043	Carded	84	1.763 lb

Cat. No.	Description	Cat. No.	Description
81009F	1/4" Drive Flex Ratchet w/Cushion Grip	81210F	3/8" Drive Flex Ratchet w/Cushion Grip

GEARWRENCH® 2 Pc. 1/4" and 3/8" Drive 120XP™ Cushion Grip Flex Handle Ratchet Set



- 120 Positions, 3° Ratcheting Arc
- The Gear is Alternately Engaged by the Double-Stacked Pawls which give a 3° Swing Arc for Faster Work
- 6-Position Flex Head for Adjustable Access Angle
- Highly Visible On/Off Markings on the Head
- Enclosed Head Design for Extreme Resistance to Dirt Infiltration
- Double-Stacked Pawls Engage a 60-tooth Gear Providing Exceptional Strength, Exceeding ASME Specifications
- Teardrop Low Profile Head and Flush Mounted On/Off Switch Allow Better Access in Tight Spaces
- Longer Reach Handle to Access Hard to Reach Fasteners
- Full Polish Chrome Handle
- Meets or Exceeds ASME B107.10



Cat. No.	UPC No.	Packaging	No. of Positions	Product Weight
81204P	099575012044	EVA Foam Tray	120	1.76 lb

Cat. No.	Description	Cat. No.	Description
81009P	1/4" Drive 120XP™ Cushion Grip Teardrop Flex Head Ratchet	81210P	3/8" 120XP™ Cushion Grip Teardrop Flex Head Ratchet

GEARWRENCH® 2 Pc. 1/4" and 3/8" Drive Cushion Grip Roto Ratchet Set

- 72 tooth gear gives a 5° swing arc for easy access
- Head rotates 180°
- Dual material cushion grip for comfort
- Bright chrome finish
- Meets or Exceeds ASME B107.10M



Cat. No.	UPC No.	Packaging	Tooth Count	Product Weight
81223	099575812231	Carded	72	1.26 lb

Cat. No.	Description	Cat. No.	Description
81224	1/4" Drive Roto Ratchet - Cushion Grip	81225	3/8" Drive Roto ratchet - Cushion Grip

GEARWRENCH® 2 Pc. 1/4" and 3/8" Drive Thumbwheel Ratchet Set

- 72 Tooth Gear for 5 Degree Ratchet Angle
- Reversing Lever
- Contoured Handle for Maximum Grip Force



Cat. No.	UPC No.	Packaging	Tooth Count	Product Weight
81222	099575812224	Carded	72	0.40 lb

Cat. No.	Description	Cat. No.	Description
81008	1/4" Drive Thumbwheel Ratchet	81226	3/8" Drive Thumbwheel Ratchet

GEARWRENCH® 10 Pc. 1/4", 3/8", and 1/2" Drive Universal Adapter Set

- Includes Universal Joints, Impact Universal Joints, and Adapters



Cat. No.	UPC No.	Packaging	Product Weight
81205	099575812057	Blow Mold Case	2.09 lb

Cat. No.	Description	Cat. No.	Description
80100	1/4" Drive Universal Joint	81127	1/4" Drive 1/4" F x 3/8" M Adapter
80549	3/8" Drive Universal Joint	81277	3/8" Drive 3/8" F x 1/4" M Adapter
80101	1/4" Drive Impact Universal Joint	81278	3/8" Drive 3/8" F x 1/2" M Adapter
80548	3/8" Drive Impact Universal Joint	81354	1/2" Drive 1/2" F x 3/8" M Adapter
80671	1/2" Drive Impact Universal Joint	81355	1/2" Drive 1/2" F x 3/4" M Adapter

GEARWRENCH® 4 Pc. 1/4", 3/8", and 1/2" Drive Adapter Set on Socket Rail

- Full Polish Chrome Finish
- Includes Socket Clip



Cat. No.	UPC No.	Packaging	Product Weight
81217	099575812170	Carded	0.32 lb
Cat. No.	Description	Cat. No.	Description
81127	1/4" Drive 1/4" F x 3/8" M Adapter	81278	3/8" Drive 3/8" F x 1/2" M Adapter
81277	3/8" Drive 3/8" F x 1/4" M Adapter	81354	1/2" Drive 1/2" F x 3/8" M Adapter

GEARWRENCH® 9 Pc. 1/4", 3/8", and 1/2" Drive Magnetic Drive Tool Set

- Full Polish Chrome Finish
- Magnetic Tips Keep the Fastener in the Socket



Cat. No.	UPC No.	Packaging	Product Weight
81235	099575812354	Carded	2.00 lb
Cat. No.	Description	Cat. No.	Description
81258	1/4" Drive 1/4" F x 3/8" M Adapter, Magnetic	81263	1/2" Drive Magnetic Extension 6"
81259	3/8" Drive 3/8" F x 1/4" M Adapter, Magnetic	81255	1/4" Drive Magnetic Universal Joint
81260	3/8" Drive 3/8" F x 1/2" M Adapter, Magnetic	81256	3/8" Drive Magnetic Universal Joint
81261	1/4" Drive Magnetic Extension 6"	81257	1/2" Drive Magnetic Universal Joint
81262	3/8" Drive Magnetic Extension 6"		

GEARWRENCH® 3 Pc. 1/4", 3/8", and 1/2" Drive Magnetic Universal Joint Set

- Magnetic Tip Keeps the Fastener in the Sockets
- Full Polish Chrome Finish



Cat. No.	UPC No.	Packaging	Product Weight
81236D	099575812361	Carded	0.64 lb
Cat. No.	Description	Cat. No.	Description
81255	1/4" Drive Magnetic Universal Joint	81257	1/2" Drive Magnetic Universal Joint
81256	3/8" Drive Magnetic Universal Joint		

GEARWRENCH® 3 Pc. 1/4", 3/8", and 1/2" Drive Magnetic Adapter Set

- Magnetic Tip Keeps the Fastener in the Socket
- Full Polish Chrome Finish



Cat. No.	UPC No.	Packaging	Product Weight
81237	099575812378	Carded	0.29 lb

Cat. No.	Description	Cat. No.	Description
81258	1/4" Drive 1/4" F x 3/8" M Adapter, Magnetic	81260	3/8" Drive 3/8" F x 1/2" M Adapter, Magnetic
81259	3/8" Drive 3/8" F x 1/4" M Adapter, Magnetic		

GEARWRENCH® 3 Pc. 1/4", 3/8", and 1/2" Drive Magnetic Extension Bar Set

- Knurled Grip Provides Non-Slip Surface
- Full Polish Chrome Finish
- Magnetic Tip Keeps the Fastener in the Socket



Cat. No.	UPC No.	Packaging	Product Weight
81238	099575812385	Carded	1.14 lb

Cat. No.	Description	Cat. No.	Description
81261	1/4" Drive Magnetic Extension 6"	81263	1/2" Drive Magnetic Extension 6"
81262	3/8" Drive Magnetic Extension 6"		

MULTIDRIVE

3

RATCHETS / SOCKETS / DRIVE TOOLS / SETS

GEARWRENCH® 36 Pc. 1/4", 3/8", and 1/2" Drive SAE/Metric Hex and Torx® Bit Socket Set

- Heat Treated Socket Bases for Durability and Serviceability
- Professional, Full Polish Chrome
- Meets or Exceeds ASME B107.1, B107.5M



Cat. No.	UPC No.	Packaging	Product Weight
80726	099575807268	Blow Mold Case	3.86 lb

Cat. No.	Description	Cat. No.	Description
80172	1/4" Drive TORX® Press Fit Bit Socket, T-10	80463	3/8" Drive External TORX® Socket, E-16
80173	1/4" Drive TORX® Press Fit Bit Socket, T-15	80416	3/8" Drive Hex Bit Socket, 5/32"
80174	1/4" Drive TORX® Press Fit Bit Socket, T-20	80417	3/8" Drive Hex Bit Socket, 3/16"
80175	1/4" Drive TORX® Press Fit Bit Socket, T-25	80418	3/8" Drive Hex Bit Socket, 7/32"
80176D	1/4" Drive TORX® Press Fit Bit Socket, T-27	80419	3/8" Drive Hex Bit Socket, 1/4"
80177D	1/4" Drive TORX® Press Fit Bit Socket, T-30	80420	3/8" Drive Hex Bit Socket, 5/16"
80187	1/4" Drive External TORX® Sockets, E-5	80421	3/8" Drive Hex Bit Socket, 3/8"
80188D	1/4" Drive External TORX® Sockets, E-6	80422	3/8" Drive Hex Bit Socket, 2mm
80189	1/4" Drive External TORX® Sockets, E-7	80423	3/8" Drive Hex Bit Socket, 2.5mm
80190	1/4" Drive External TORX® Sockets, E-8	80424	3/8" Drive Hex Bit Socket, 3mm
80451	3/8" Drive TORX® Press-Fit Bit Socket, T-40	80425	3/8" Drive Hex Bit Socket, 4mm
80452	3/8" Drive TORX® Press-Fit Bit Socket, T-45	80426	3/8" Drive Hex Bit Socket, 5mm
80453	3/8" Drive TORX® Press-Fit Bit Socket, T-47	80427	3/8" Drive Hex Bit Socket, 6mm
80454	3/8" Drive TORX® Press-Fit Bit Socket, T-50	80428D	3/8" Drive Hex Bit Socket, 7mm
80455	3/8" Drive TORX® Press-Fit Bit Socket, T-55	80429	3/8" Drive Hex Bit Socket, 8mm
80460	3/8" Drive External TORX® Socket, E-10	80430	3/8" Drive Hex Bit Socket, 9mm
80461	3/8" Drive External TORX® Socket, E-12	80431	3/8" Drive Hex Bit Socket, 10mm
80462	3/8" Drive External TORX® Socket, E-14	80669D	1/2" Drive External Torx® Socket, E-18

MULTIDRIVE

3

RATCHETS / SOCKETS / DRIVE TOOLS / SETS

GEARWRENCH® 36 Pc. 1/4", 3/8", and 1/2" Drive Torx® Bit Socket Set

- Heat Treated Socket Bases for Durability and Serviceability
- Professional, Full Polish Chrome



Cat. No.	UPC No.	Packaging	Product Weight
80727	099575807275	Blow Mold Case	4.63 lb

Cat. No.	Description	Cat. No.	Description
80171	1/4" Drive TORX® Press Fit Bit Socket, T-8	80189	1/4" Drive External TORX® Sockets, E-7
80172	1/4" Drive TORX® Press Fit Bit Socket, T-10	80190	1/4" Drive External TORX® Sockets, E-8
80173	1/4" Drive TORX® Press Fit Bit Socket, T-15	80451	3/8" Drive TORX® Press-Fit Bit Socket, T-40
80174	1/4" Drive TORX® Press Fit Bit Socket, T-20	80452	3/8" Drive TORX® Press-Fit Bit Socket, T-45
80175	1/4" Drive TORX® Press Fit Bit Socket, T-25	80453	3/8" Drive TORX® Press-Fit Bit Socket, T-47
80176D	1/4" Drive TORX® Press Fit Bit Socket, T-27	80454	3/8" Drive TORX® Press-Fit Bit Socket, T-50
80177D	1/4" Drive TORX® Press Fit Bit Socket, T-30	80455	3/8" Drive TORX® Press-Fit Bit Socket, T-55
80178	1/4" Drive TORX® Tamper-Proof Bit Socket, T-7	80456D	3/8" Drive TORX® Tamper-Proof Bit Socket, T-40
80179	1/4" Drive TORX® Tamper-Proof Bit Socket, T-8	80457	3/8" Drive TORX® Tamper-Proof Bit Socket, T-45
80180	1/4" Drive TORX® Tamper-Proof Bit Socket, T-10	80458	3/8" Drive TORX® Tamper-Proof Bit Socket, T-50
80181	1/4" Drive TORX® Tamper-Proof Bit Socket, T-15	80459	3/8" Drive TORX® Tamper-Proof Bit Socket, T-55
80182	1/4" Drive TORX® Tamper-Proof Bit Socket, T-20	80460	3/8" Drive External TORX® Socket, E-10
80183	1/4" Drive TORX® Tamper-Proof Bit Socket, T-25	80461	3/8" Drive External TORX® Socket, E-12
80184	1/4" Drive TORX® Tamper-Proof Bit Socket, T-27	80462	3/8" Drive External TORX® Socket, E-14
80185	1/4" Drive TORX® Tamper-Proof Bit Socket, T-30	80463	3/8" Drive External TORX® Socket, E-16
80186	1/4" Drive External TORX® Sockets, E-4	80669D	1/2" Drive External Torx® Socket, E-18
80187	1/4" Drive External TORX® Sockets, E-5	80670	1/2" Drive External Torx® Socket, E-20
80188D	1/4" Drive External TORX® Sockets, E-6	80667	1/2" Drive TORX® Press Fit Bit Socket, T-60

GEARWRENCH® 13 Pc. 1/4", 3/8", and 1/2" Drive Torx® Bit Socket Set

- Heat Treated Socket Bases for Durability and Serviceability
- Professional, Full Polish Chrome
- Includes Socket Rail



Cat. No.	UPC No.	Packaging	Product Weight
80723	099575807237	Carded	1.32 lb

Cat. No.	Description	Cat. No.	Description
80171	1/4" Drive TORX® Press Fit Bit Socket, T-8	80451	3/8" Drive TORX® Press-Fit Bit Socket, T-40
80172	1/4" Drive TORX® Press Fit Bit Socket, T-10	80452	3/8" Drive TORX® Press-Fit Bit Socket, T-45
80173	1/4" Drive TORX® Press Fit Bit Socket, T-15	80453	3/8" Drive TORX® Press-Fit Bit Socket, T-47
80174	1/4" Drive TORX® Press Fit Bit Socket, T-20	80454	3/8" Drive TORX® Press-Fit Bit Socket, T-50
80175	1/4" Drive TORX® Press Fit Bit Socket, T-25	80455	3/8" Drive TORX® Press-Fit Bit Socket, T-55
80176D	1/4" Drive TORX® Press Fit Bit Socket, T-27	80667	1/2" Drive TORX® Press Fit Bit Socket, T-60
80177D	1/4" Drive TORX® Press Fit Bit Socket, T-30		

GEARWRENCH® 13 Pc. 1/4", 3/8", and 1/2" Drive Torx® Tamper Proof Bit Socket Set

- Heat Treated Socket Bases for Durability and Serviceability
- Professional, Full Polish Chrome
- Includes Socket Rail



Cat. No.	UPC No.	Packaging	Product Weight
80725	099575807251	Carded	1.38 lb

Cat. No.	Description	Cat. No.	Description
80178	1/4" Drive TORX® Tamper-Proof Bit Socket, T-7	80185	1/4" Drive TORX® Tamper-Proof Bit Socket, T-30
80179	1/4" Drive TORX® Tamper-Proof Bit Socket, T-8	80456D	3/8" Drive TORX® Tamper-Proof Bit Socket, T-40
80180	1/4" Drive TORX® Tamper-Proof Bit Socket, T-10	80457	3/8" Drive TORX® Tamper-Proof Bit Socket, T-45
80181	1/4" Drive TORX® Tamper-Proof Bit Socket, T-15	80458	3/8" Drive TORX® Tamper-Proof Bit Socket, T-50
80182	1/4" Drive TORX® Tamper-Proof Bit Socket, T-20	80459	3/8" Drive TORX® Tamper-Proof Bit Socket, T-55
80183	1/4" Drive TORX® Tamper-Proof Bit Socket, T-25	80668	1/2" Drive TORX® Tamper-Proof Bit Sockets, T-60
80184	1/4" Drive TORX® Tamper-Proof Bit Socket, T-27		

GEARWRENCH® 13 Pc. 1/4", 3/8", and 1/2" Drive External Torx® Socket Set

- Heat Treated Socket Bases for Durability and Serviceability
- Includes Socket Rail



Cat. No.	UPC No.	Packaging	Product Weight
80583	099575805837	Carded	2.08 lb

Cat. No.	Description	Cat. No.	Description
80186	1/4" Drive External TORX® Sockets, E-4	80462	3/8" Drive External TORX® Socket, E-14
80187	1/4" Drive External TORX® Sockets, E-5	80463	3/8" Drive External TORX® Socket, E-16
80188D	1/4" Drive External TORX® Sockets, E-6	80669D	1/2" Drive External Torx® Socket, E-18
80189	1/4" Drive External TORX® Sockets, E-7	80670	1/2" Drive External Torx® Socket, E-20
80190	1/4" Drive External TORX® Sockets, E-8	80672	1/2" Drive External Torx Socket, E-22
80460	3/8" Drive External TORX® Socket, E-10	80673	1/2" Drive External Torx Socket, E-24
80461	3/8" Drive External TORX® Socket, E-12		

GEARWRENCH® 11 Pc. 3/8" Drive Torx® Tamper Proof Bit Socket Set

- Heat Treated Socket Bases for Durability and Serviceability
- Professional, Full Polish Chrome
- Includes Socket Rail



Cat. No.	UPC No.	Packaging	Product Weight
80724	099575807244	Carded	0.37 lb

Cat. No.	Description	Cat. No.	Description
80480	1/4" Bit Adapter 1/4" Drive	80475	Insert Bit T-27 Tamper Proof Torx® Bit
80481	5/16" Bit Adapter 3/8" Drive	80476	Insert Bit T-30 Tamper Proof Torx® Bit
80471	Insert Bit T-10 Tamper Proof Torx® Bit	80477	Insert Bit T-40 Tamper Proof Internal Torx® Bit
80472	Insert Bit T-15 Tamper Proof Torx® Bit	80478	Insert Bit T-45 Tamper Proof Internal Torx® Bit
80473	Insert Bit T-20 Tamper Proof Torx® Bit	80479D	Insert Bit T-50 Tamper Proof Internal Torx® Bit
80474	Insert Bit T-25 Tamper Proof Torx® Bit		

GEARWRENCH® 10 Pc. 1/4" and 3/8" Drive Torx® Bit Socket Set

- Heat Treated Socket Bases for Durability and Serviceability
- Professional, Full Polish Chrome
- Includes Socket Rail



Cat. No.	UPC No.	Packaging	Product Weight
80722	099575807220	Carded	0.98 lb

Cat. No.	Description	Cat. No.	Description
80172	1/4" Drive TORX® Press Fit Bit Socket, T-10	80177D	1/4" Drive TORX® Press Fit Bit Socket, T-30
80173	1/4" Drive TORX® Press Fit Bit Socket, T-15	80451	3/8" Drive TORX® Press-Fit Bit Socket, T-40
80174	1/4" Drive TORX® Press Fit Bit Socket, T-20	80452	3/8" Drive TORX® Press-Fit Bit Socket, T-45
80175	1/4" Drive TORX® Press Fit Bit Socket, T-25	80454	3/8" Drive TORX® Press-Fit Bit Socket, T-50
80176D	1/4" Drive TORX® Press Fit Bit Socket, T-27	80455	3/8" Drive TORX® Press-Fit Bit Socket, T-55

GEARWRENCH® 10 Pc. 1/4" and 3/8" Drive Long Torx® Bit Socket Set

- Heat Treated Socket Bases for Durability and Serviceability
- Professional, Full Polish Chrome
- Includes Socket Rail
- All Bit Sockets 6" Long



Cat. No.	UPC No.	Packaging	Product Weight
80588	099575805882	Carded	1.65 lb

Cat. No.	Description	Cat. No.	Description
82510	1/4" Drive Long TORX® Bit Socket, T-8	82515	1/4" Drive Long TORX® Bit Socket, T-27
82511	1/4" Drive Long TORX® Bit Socket, T-10	82516	1/4" Drive Long TORX® Bit Socket, T-30
82512	1/4" Drive Long TORX® Bit Socket, T-15	82517	3/8" Drive Long TORX® Bit Socket, T-40
82513	1/4" Drive Long TORX® Bit Socket, T-20	82518	3/8" Drive Long TORX® Bit Socket, T-45
82514	1/4" Drive Long TORX® Bit Socket, T-25	82519	3/8" Drive Long TORX® Bit Socket, T-50

GEARWRENCH® 10 Pc. 1/4", 3/8", and 1/2" Drive External Torx® Socket Set

- Heat Treated Socket Bases for Durability and Serviceability
- Includes Socket Rail



Cat. No.	UPC No.	Packaging	Product Weight
80582	099575805820	Carded	1.59 lb

Cat. No.	Description	Cat. No.	Description
80186	1/4" Drive External TORX® Sockets, E-4	80460	3/8" Drive External TORX® Socket, E-10
80187	1/4" Drive External TORX® Sockets, E-5	80461	3/8" Drive External TORX® Socket, E-12
80188D	1/4" Drive External TORX® Sockets, E-6	80462	3/8" Drive External TORX® Socket, E-14
80189	1/4" Drive External TORX® Sockets, E-7	80463	3/8" Drive External TORX® Socket, E-16
80190	1/4" Drive External TORX® Sockets, E-8	80669D	1/2" Drive External Torx® Socket, E-18

GEARWRENCH® 10 Pc. 3/8" and 1/2" Drive SAE Hex Bit Socket Set

- Heat Treated Socket Bases for Durability and Serviceability
- Professional, Full Polish Chrome
- Includes Socket Rail
- Meets or Exceeds ASME B107.1



Cat. No.	UPC No.	Packaging	Product Weight
80579	099575805790	Carded	1.99 lb

Cat. No.	Description	Cat. No.	Description
80414	3/8" Drive Hex Bit Socket, 1/8"	80420	3/8" Drive Hex Bit Socket, 5/16"
80416	3/8" Drive Hex Bit Socket, 5/32"	80421	3/8" Drive Hex Bit Socket, 3/8"
80417	3/8" Drive Hex Bit Socket, 3/16"	80654	1/2" Drive Hex Bit Socket, 1/2"
80418	3/8" Drive Hex Bit Socket, 7/32"	80655	1/2" Drive Hex Bit Socket, 9/16"
80419	3/8" Drive Hex Bit Socket, 1/4"	80656	1/2" Drive Hex Bit Socket, 5/8"

GEARWRENCH® 10 Pc. 3/8" and 1/2" Drive Metric Hex Bit Socket Set

- Heat Treated Socket Bases for Durability and Serviceability
- Professional, Full Polish Chrome
- Includes Socket Rail
- Meets or Exceeds ASME B107.5M



Cat. No.	UPC No.	Packaging	Product Weight
80578	099575805783	Carded	1.89 lb

Cat. No.	Description	Cat. No.	Description
80425	3/8" Drive Hex Bit Socket, 4mm	80430	3/8" Drive Hex Bit Socket, 9mm
80426	3/8" Drive Hex Bit Socket, 5mm	80431	3/8" Drive Hex Bit Socket, 10mm
80427	3/8" Drive Hex Bit Socket, 6mm	80661	1/2" Drive Hex Bit Socket, 12mm
80428D	3/8" Drive Hex Bit Socket, 7mm	80662	1/2" Drive Hex Bit Socket, 14mm
80429	3/8" Drive Hex Bit Socket, 8mm	80663	1/2" Drive Hex Bit Socket, 17mm

GEARWRENCH® 4 Pc. 3/8" and 1/2" Drive Metric Triple Square Bit Socket Set

- Heat Treated Socket Bases for Durability and Serviceability
- Professional, Full Polish Chrome
- Includes Socket Rail
- Meets or Exceeds ASME B107.5M



Cat. No.	UPC No.	Packaging	Product Weight
80572	099575805721	Carded	0.46 lb

Cat. No.	Description	Cat. No.	Description
80449	3/8" Drive Triple Square Bit Socket, 6mm	80665	1/2" Drive Triple Square Bit Socket, 10mm
80450	3/8" Drive Triple Square Bit Socket, 8mm	80666	1/2" Drive Triple Square Bit Socket, 12mm

MULTIDRIVE

3

RATCHETS / SOCKETS / DRIVE TOOLS / SETS

GEARWRENCH® 54 Pc. 1/4" Drive 6 Point Metric Standard and Deep Mechanics Tool Set

- Full Polish Chrome Sockets With Large Hard Stamp Size Markings
- Includes Storage Case
- 84 Tooth Full Polish Chrome Thin Profile Ratchet
- Knurled Full Polish Chrome Extensions
- Sockets Feature Surface Drive® Technology to Reduce Fastener Rounding



Cat. No.	UPC No.	Packaging	Product Weight
80315	099575803154	Boxed	4.85 lb

Cat. No.	Description	Cat. No.	Description
81011F	1/4" Drive Full Polish Teardrop Ratchet	80143	1/4" Drive 6 Point Deep Metric Socket 8mm
81008	1/4" Drive Thumbwheel Ratchet	80144	1/4" Drive 6 Point Deep Metric Socket 9mm
81127	1/4" Drive 1/4" F x 3/8" M Adapter	80145	1/4" Drive 6 Point Deep Metric Socket 10mm
81277	3/8" Drive 3/8" F x 1/4" M Adapter	80146D	1/4" Drive 6 Point Deep Metric Socket 11mm
80167	1/4" Drive Triple Square Bit Socket, 4mm	80147	1/4" Drive 6 Point Deep Metric Socket 12mm
80168	1/4" Drive Triple Square Bit Socket, 5mm	80148	1/4" Drive 6 Point Deep Metric Socket 13mm
80169	1/4" Drive Triple Square Bit Socket, 6mm	80149	1/4" Drive 6 Point Deep Metric Socket 14mm
80170D	1/4" Drive Triple Square Bit Socket, 8mm	80150	1/4" Drive 6 Point Deep Metric Socket 15mm
81101	1/4" Drive Standard Extension 2"	80100	1/4" Drive Universal Joint
81116	1/4" Drive Standard Extension 6"	80250	1/4" Drive 6 Point Flex Socket 5mm
80125	1/4" Drive 6 Point Standard Metric Socket 4mm	80251D	1/4" Drive 6 Point Flex Socket 5.5mm
80126	1/4" Drive 6 Point Standard Metric Socket 5mm	80252	1/4" Drive 6 Point Flex Socket 6mm
80127	1/4" Drive 6 Point Standard Metric Socket 5.5mm	80253	1/4" Drive 6 Point Flex Socket 7mm
80128	1/4" Drive 6 Point Standard Metric Socket 6mm	80254	1/4" Drive 6 Point Flex Socket 8mm
80129	1/4" Drive 6 Point Standard Metric Socket 7mm	80255	1/4" Drive 6 Point Flex Socket 9mm
80130	1/4" Drive 6 Point Standard Metric Socket 8mm	80256	1/4" Drive 6 Point Flex Socket 10mm
80131D	1/4" Drive 6 Point Standard Metric Socket 9mm	80257	1/4" Drive 6 Point Flex Socket 11mm
80132	1/4" Drive 6 Point Standard Metric Socket 10mm	80258	1/4" Drive 6 Point Flex Socket 12mm
80133	1/4" Drive 6 Point Standard Metric Socket 11mm	80259	1/4" Drive 6 Point Flex Socket 13mm
80134	1/4" Drive 6 Point Standard Metric Socket 12mm	80260	1/4" Drive 6 Point Flex Socket 14mm
80135D	1/4" Drive 6 Point Standard Metric Socket 13mm	80261	1/4" Drive 6 Point Flex Socket 15mm
80136	1/4" Drive 6 Point Standard Metric Socket 14mm	80191	1/4" Drive Deep External TORX® Socket, E-4
80137	1/4" Drive 6 Point Standard Metric Socket 15mm	80192	1/4" Drive Deep External TORX® Socket, E-5
80138	1/4" Drive 6 Point Deep Metric Socket 4mm	80193	1/4" Drive Deep External TORX® Socket, E-6
80139	1/4" Drive 6 Point Deep Metric Socket 5mm	80194	1/4" Drive Deep External TORX® Socket, E-7
80140	1/4" Drive 6 Point Deep Metric Socket 5.5mm	80195	1/4" Drive Deep External TORX® Socket, E-8
80141	1/4" Drive 6 Point Deep Metric Socket 6mm	80196	1/4" Drive Deep External TORX® Socket, E-10
80142	1/4" Drive 6 Point Deep Metric Socket 7mm	80243	1/4" Drive Deep External TORX® Socket, E-11

GEARWRENCH® 51 Pc. 1/4" Drive 6 Point SAE/Metric Standard and Deep Mechanics Tool Set

120XP

- 120 Position, 3° ratcheting arc ratchet with teardrop low profile head and flush mounted on/off switch for improved access
- Full Polish Chrome Sockets With Large Hard Stamp Size Markings
- Knurled Full Polish Extensions
- Sockets Feature Surface Drive® Technology To Reduce Fastener Rounding
- Meets or Exceeds ASME B107.1, B107.5M, B107.10
- Includes storage case



Cat. No.	UPC No.	Packaging	Product Weight
80300P	099575830105	Boxed	4.75 lb

Cat. No.	Description	Cat. No.	Description
81011P	1/4" Drive 120XP Full Polish Teardrop Ratchet	80127	1/4" Drive 6 Point Standard Metric Socket 5.5mm
81008	1/4" Drive Thumbwheel Ratchet	80128	1/4" Drive 6 Point Standard Metric Socket 6mm
81101	1/4" Drive Standard Extension 2"	80129	1/4" Drive 6 Point Standard Metric Socket 7mm
81116	1/4" Drive Standard Extension 6"	80130	1/4" Drive 6 Point Standard Metric Socket 8mm
80105	1/4" Drive 6 Point Standard SAE Socket 3/16"	80131D	1/4" Drive 6 Point Standard Metric Socket 9mm
80106	1/4" Drive 6 Point Standard SAE Socket 7/32"	80132	1/4" Drive 6 Point Standard Metric Socket 10mm
80107	1/4" Drive 6 Point Standard SAE Socket 1/4"	80133	1/4" Drive 6 Point Standard Metric Socket 11mm
80108	1/4" Drive 6 Point Standard SAE Socket 9/32"	80134	1/4" Drive 6 Point Standard Metric Socket 12mm
80109	1/4" Drive 6 Point Standard SAE Socket 5/16"	80135D	1/4" Drive 6 Point Standard Metric Socket 13mm
80110	1/4" Drive 6 Point Standard SAE Socket 11/32"	80136	1/4" Drive 6 Point Standard Metric Socket 14mm
80111	1/4" Drive 6 Point Standard SAE Socket 3/8"	80137	1/4" Drive 6 Point Standard Metric Socket 15mm
80112	1/4" Drive 6 Point Standard SAE Socket 7/16"	80138	1/4" Drive 6 Point Deep Metric Socket 4mm
80113D	1/4" Drive 6 Point Standard SAE Socket 1/2"	80139	1/4" Drive 6 Point Deep Metric Socket 5mm
80114D	1/4" Drive 6 Point Standard SAE Socket 9/16"	80140	1/4" Drive 6 Point Deep Metric Socket 5.5mm
80115	1/4" Drive 6 Point Deep SAE Socket 3/16"	80141	1/4" Drive 6 Point Deep Metric Socket 6mm
80116D	1/4" Drive 6 Point Deep SAE Socket 7/32"	80142	1/4" Drive 6 Point Deep Metric Socket 7mm
80117	1/4" Drive 6 Point Deep SAE Socket 1/4"	80143	1/4" Drive 6 Point Deep Metric Socket 8mm
80118	1/4" Drive 6 Point Deep SAE Socket 9/32"	80144	1/4" Drive 6 Point Deep Metric Socket 9mm
80119	1/4" Drive 6 Point Deep SAE Socket 5/16"	80145	1/4" Drive 6 Point Deep Metric Socket 10mm
80120D	1/4" Drive 6 Point Deep SAE Socket 11/32"	80146D	1/4" Drive 6 Point Deep Metric Socket 11mm
80121	1/4" Drive 6 Point Deep SAE Socket 3/8"	80147	1/4" Drive 6 Point Deep Metric Socket 12mm
80122D	1/4" Drive 6 Point Deep SAE Socket 7/16"	80148	1/4" Drive 6 Point Deep Metric Socket 13mm
80123	1/4" Drive 6 Point Deep SAE Socket 1/2"	80149	1/4" Drive 6 Point Deep Metric Socket 14mm
80124	1/4" Drive 6 Point Deep SAE Socket 9/16"	80150	1/4" Drive 6 Point Deep Metric Socket 15mm
80125	1/4" Drive 6 Point Standard Metric Socket 4mm	80100	1/4" Drive Universal Joint
80126	1/4" Drive 6 Point Standard Metric Socket 5mm		

1 / 4 " 3 RATCHETS / SOCKETS / DRIVE TOOLS / SETS

GEARWRENCH® 51 Pc. 1/4" Drive 6 Point SAE/Metric Standard and Deep Mechanics Tool Set

- Full Polish Chrome Sockets With Large Hard Stamp Size Markings
- Includes Storage Case
- 84 Tooth Full Polish Chrome Thin Profile Ratchet
- Knurled Full Polish Chrome Extensions
- Included Thumbwheel Ratchet for Access in Tight Spaces
- Sockets Feature Surface Drive® Technology to Reduce Fastener Rounding
- Meets or Exceeds ASME B107.1, B107.5M, B107.10



Cat. No.	UPC No.	Packaging	Product Weight
80300	099575803000	Boxed	4.85 lb

Cat. No.	Description	Cat. No.	Description
81011F	1/4" Drive Full Polish Teardrop Ratchet	80127	1/4" Drive 6 Point Standard Metric Socket 5.5mm
81008	1/4" Drive Thumbwheel Ratchet	80128	1/4" Drive 6 Point Standard Metric Socket 6mm
81101	1/4" Drive Standard Extension 2"	80129	1/4" Drive 6 Point Standard Metric Socket 7mm
81116	1/4" Drive Standard Extension 6"	80130	1/4" Drive 6 Point Standard Metric Socket 8mm
80105	1/4" Drive 6 Point Standard SAE Socket 3/16"	80131D	1/4" Drive 6 Point Standard Metric Socket 9mm
80106	1/4" Drive 6 Point Standard SAE Socket 7/32"	80132	1/4" Drive 6 Point Standard Metric Socket 10mm
80107	1/4" Drive 6 Point Standard SAE Socket 1/4"	80133	1/4" Drive 6 Point Standard Metric Socket 11mm
80108	1/4" Drive 6 Point Standard SAE Socket 9/32"	80134	1/4" Drive 6 Point Standard Metric Socket 12mm
80109	1/4" Drive 6 Point Standard SAE Socket 5/16"	80135D	1/4" Drive 6 Point Standard Metric Socket 13mm
80110	1/4" Drive 6 Point Standard SAE Socket 11/32"	80136	1/4" Drive 6 Point Standard Metric Socket 14mm
80111	1/4" Drive 6 Point Standard SAE Socket 3/8"	80137	1/4" Drive 6 Point Standard Metric Socket 15mm
80112	1/4" Drive 6 Point Standard SAE Socket 7/16"	80138	1/4" Drive 6 Point Deep Metric Socket 4mm
80113D	1/4" Drive 6 Point Standard SAE Socket 1/2"	80139	1/4" Drive 6 Point Deep Metric Socket 5mm
80114D	1/4" Drive 6 Point Standard SAE Socket 9/16"	80140	1/4" Drive 6 Point Deep Metric Socket 5.5mm
80115	1/4" Drive 6 Point Deep SAE Socket 3/16"	80141	1/4" Drive 6 Point Deep Metric Socket 6mm
80116D	1/4" Drive 6 Point Deep SAE Socket 7/32"	80142	1/4" Drive 6 Point Deep Metric Socket 7mm
80117	1/4" Drive 6 Point Deep SAE Socket 1/4"	80143	1/4" Drive 6 Point Deep Metric Socket 8mm
80118	1/4" Drive 6 Point Deep SAE Socket 9/32"	80144	1/4" Drive 6 Point Deep Metric Socket 9mm
80119	1/4" Drive 6 Point Deep SAE Socket 5/16"	80145	1/4" Drive 6 Point Deep Metric Socket 10mm
80120D	1/4" Drive 6 Point Deep SAE Socket 11/32"	80146D	1/4" Drive 6 Point Deep Metric Socket 11mm
80121	1/4" Drive 6 Point Deep SAE Socket 3/8"	80147	1/4" Drive 6 Point Deep Metric Socket 12mm
80122D	1/4" Drive 6 Point Deep SAE Socket 7/16"	80148	1/4" Drive 6 Point Deep Metric Socket 13mm
80123	1/4" Drive 6 Point Deep SAE Socket 1/2"	80149	1/4" Drive 6 Point Deep Metric Socket 14mm
80124	1/4" Drive 6 Point Deep SAE Socket 9/16"	80150	1/4" Drive 6 Point Deep Metric Socket 15mm
80125	1/4" Drive 6 Point Standard Metric Socket 4mm	80100	1/4" Drive Universal Joint
80126	1/4" Drive 6 Point Standard Metric Socket 5mm		

GEARWRENCH® 51 Pc. 1/4" Drive 12 Point SAE/Metric Standard and Deep Mechanics Tool Set

- Full Polish Chrome Sockets With Large Hard Stamp Size Markings
- Includes Storage Case
- 84 Tooth Full Polish Chrome Thin Profile Ratchet
- Knurled Full Polish Chrome Extensions
- Sockets Feature Surface Drive® Technology Reduces Fastener Rounding
- Included Thumbwheel Ratchet for Access in Tight Spaces
- Meets or Exceeds ASME B107.1, B107.5M, B107.10



Cat. No.	UPC No.	Packaging	Product Weight
80301	099575803017	Boxed	4.85 lb

Cat. No.	Description	Cat. No.	Description
81011F	1/4" Drive Full Polish Teardrop Ratchet	80199	1/4" Drive 12 Point Standard Socket 5.5mm
81008	1/4" Drive Thumbwheel Ratchet	80200	1/4" Drive 12 Point Standard Socket 6mm
81101	1/4" Drive Standard Extension 2"	80201	1/4" Drive 12 Point Standard Socket 7mm
81116	1/4" Drive Standard Extension 6"	80202	1/4" Drive 12 Point Standard Socket 8mm
80210	1/4" Drive 12 Point Standard SAE Socket 3/16"	80203	1/4" Drive 12 Point Standard Socket 9mm
80211	1/4" Drive 12 Point Standard SAE Socket 7/32"	80204	1/4" Drive 12 Point Standard Socket 10mm
80212	1/4" Drive 12 Point Standard SAE Socket 1/4"	80205	1/4" Drive 12 Point Standard Socket 11mm
80213	1/4" Drive 12 Point Standard SAE Socket 9/32"	80206	1/4" Drive 12 Point Standard Socket 12mm
80214	1/4" Drive 12 Point Standard SAE Socket 5/16"	80207	1/4" Drive 12 Point Standard Socket 13mm
80215D	1/4" Drive 12 Point Standard SAE Socket 11/32"	80208	1/4" Drive 12 Point Standard Socket 14mm
80216	1/4" Drive 12 Point Standard SAE Socket 3/8"	80209	1/4" Drive 12 Point Standard Socket 15mm
80217	1/4" Drive 12 Point Standard SAE Socket 7/16"	80230	1/4" Drive 12 Point Deep Socket 4mm
80218	1/4" Drive 12 Point Standard SAE Socket 1/2"	80231	1/4" Drive 12 Point Deep Socket 5mm
80219	1/4" Drive 12 Point Standard SAE Socket 9/16"	80232	1/4" Drive 12 Point Deep Socket 5.5mm
80220	1/4" Drive 12 Point Deep Socket 3/16"	80233	1/4" Drive 12 Point Deep Socket 6mm
80221	1/4" Drive 12 Point Deep Socket 7/32"	80234	1/4" Drive 12 Point Deep Socket 7mm
80222	1/4" Drive 12 Point Deep Socket 1/4"	80235	1/4" Drive 12 Point Deep Socket 8mm
80223D	1/4" Drive 12 Point Deep Socket 9/32"	80236	1/4" Drive 12 Point Deep Socket 9mm
80224	1/4" Drive 12 Point Deep Socket 5/16"	80237	1/4" Drive 12 Point Deep Socket 10mm
80225	1/4" Drive 12 Point Deep Socket 11/32"	80238	1/4" Drive 12 Point Deep Socket 11mm
80226	1/4" Drive 12 Point Deep Socket 3/8"	80239D	1/4" Drive 12 Point Deep Socket 12mm
80227	1/4" Drive 12 Point Deep Socket 7/16"	80240	1/4" Drive 12 Point Deep Socket 13mm
80228	1/4" Drive 12 Point Deep Socket 1/2"	80241	1/4" Drive 12 Point Deep Socket 14mm
80229	1/4" Drive 12 Point Deep Socket 9/16"	80242	1/4" Drive 12 Point Deep Socket 15mm
80197	1/4" Drive 12 Point Standard Socket 4mm	80100	1/4" Drive Universal Joint
80198	1/4" Drive 12 Point Standard Socket 5mm		

1 / 4 " RATCHETS / SOCKETS / DRIVE TOOLS / SETS 3

GEARWRENCH® 26 Pc. 1/4" Drive 6 Point SAE Standard and Deep Mechanics Tool Set

- Full Polish Chrome Sockets With Large Hard Stamp Size Markings
- Includes Storage Case
- 84 Tooth Full Polish Chrome Thin Profile Ratchet
- Knurled Full Polish Chrome Extensions
- 1/4" Socket Driver With Ergonomic Dual Material Handle
- Sockets Feature Surface Drive® Technology To Reduce Fastener Rounding
- Meets or Exceeds ASME B107.1, B107.5M, B107.10



Cat. No.	UPC No.	Packaging	Product Weight
80312DD	099575803123	Boxed	2.95 lb

Cat. No.	Description	Cat. No.	Description
81011F	1/4" Drive Full Polish Teardrop Ratchet	80113D	1/4" Drive 6 Point Standard SAE Socket 1/2"
81128	1/4" Socket Driver	80114D	1/4" Drive 6 Point Standard SAE Socket 9/16"
81113D	1/4" Drive Standard Extension 3"	80115	1/4" Drive 6 Point Deep SAE Socket 3/16"
81116	1/4" Drive Standard Extension 6"	80116D	1/4" Drive 6 Point Deep SAE Socket 7/32"
80104D	1/4" Drive 6 Point Standard SAE Socket 5/32"	80117	1/4" Drive 6 Point Deep SAE Socket 1/4"
80105	1/4" Drive 6 Point Standard SAE Socket 3/16"	80118	1/4" Drive 6 Point Deep SAE Socket 9/32"
80106	1/4" Drive 6 Point Standard SAE Socket 7/32"	80119	1/4" Drive 6 Point Deep SAE Socket 5/16"
80107	1/4" Drive 6 Point Standard SAE Socket 1/4"	80120D	1/4" Drive 6 Point Deep SAE Socket 11/32"
80108	1/4" Drive 6 Point Standard SAE Socket 9/32"	80121	1/4" Drive 6 Point Deep SAE Socket 3/8"
80109	1/4" Drive 6 Point Standard SAE Socket 5/16"	80122D	1/4" Drive 6 Point Deep SAE Socket 7/16"
80110	1/4" Drive 6 Point Standard SAE Socket 11/32"	80123	1/4" Drive 6 Point Deep SAE Socket 1/2"
80111	1/4" Drive 6 Point Standard SAE Socket 3/8"	80124	1/4" Drive 6 Point Deep SAE Socket 9/16"
80112	1/4" Drive 6 Point Standard SAE Socket 7/16"	80100	1/4" Drive Universal Joint

GEARWRENCH 26 Pc. 1/4" Drive 12 Point SAE Standard and Deep Mechanics Tool Set

- Full Polish Chrome Sockets With Large Hard Stamp Size Markings
- Includes Storage Case
- 84 Tooth Full Polish Chrome Thin Profile Ratchet
- Knurled Full Polish Chrome Extensions
- 1/4" Socket Driver With Ergonomic Dual Material Handle
- Sockets Feature Surface Drive® Technology To Reduce Fastener Rounding
- Meets or Exceeds ASME B107.1, B107.10



Cat. No.	UPC No.	Packaging	Product Weight
80313	099575803130	Boxed	2.89 lb

Cat. No.	Description	Cat. No.	Description
81011F	1/4" Drive Full Polish Teardrop Ratchet	80218	1/4" Drive 12 Point Standard SAE Socket 1/2"
81128	1/4" Socket Driver	80219	1/4" Drive 12 Point Standard SAE Socket 9/16"
81113D	1/4" Drive Standard Extension 3"	80220	1/4" Drive 12 Point Deep Socket 3/16"
81116	1/4" Drive Standard Extension 6"	80221	1/4" Drive 12 Point Deep Socket 7/32"
80290	1/4" Drive 12 Point Standard SAE Socket 5/32"	80222	1/4" Drive 12 Point Deep Socket 1/4"
80210	1/4" Drive 12 Point Standard SAE Socket 3/16"	80223D	1/4" Drive 12 Point Deep Socket 9/32"
80211	1/4" Drive 12 Point Standard SAE Socket 7/32"	80224	1/4" Drive 12 Point Deep Socket 5/16"
80212	1/4" Drive 12 Point Standard SAE Socket 1/4"	80225	1/4" Drive 12 Point Deep Socket 11/32"
80213	1/4" Drive 12 Point Standard SAE Socket 9/32"	80226	1/4" Drive 12 Point Deep Socket 3/8"
80214	1/4" Drive 12 Point Standard SAE Socket 5/16"	80227	1/4" Drive 12 Point Deep Socket 7/16"
80215D	1/4" Drive 12 Point Standard SAE Socket 11/32"	80228	1/4" Drive 12 Point Deep Socket 1/2"
80216	1/4" Drive 12 Point Standard SAE Socket 3/8"	80229	1/4" Drive 12 Point Deep Socket 9/16"
80217	1/4" Drive 12 Point Standard SAE Socket 7/16"	80100	1/4" Drive Universal Joint

1 / 4 "

3

RATCHETS / SOCKETS / DRIVE TOOLS / SETS

GEARWRENCH® 22 Pc. 1/4" Drive 6 and 12 Point SAE Standard and Deep Mechanics Tool Set

- Full Polish Chrome Sockets With Large Hard Stamp Size Markings
- Includes Storage Case
- 84 Tooth Full Polish Chrome Thin Profile Ratchet
- Knurled Full Polish Chrome Extensions
- 1/4" Socket Driver With Ergonomic Dual Material Handle
- Sockets Feature Surface Drive® Technology To Reduce Fastener Rounding
- Meets or Exceeds ASME B107.1, B107.10



Cat. No.	UPC No.	Packaging	Product Weight
80325	099575803253	Boxed	2.86 lb

Cat. No.	Description	Cat. No.	Description
81011F	1/4" Drive Full Polish Teardrop Ratchet	80122D	1/4" Drive 6 Point Deep SAE Socket 7/16"
81128	1/4" Socket Driver	80123	1/4" Drive 6 Point Deep SAE Socket 1/2"
81101	1/4" Drive Standard Extension 2"	80210	1/4" Drive 12 Point Standard SAE Socket 3/16"
81116	1/4" Drive Standard Extension 6"	80211	1/4" Drive 12 Point Standard SAE Socket 7/32"
80115	1/4" Drive 6 Point Deep SAE Socket 3/16"	80212	1/4" Drive 12 Point Standard SAE Socket 1/4"
80116D	1/4" Drive 6 Point Deep SAE Socket 7/32"	80213	1/4" Drive 12 Point Standard SAE Socket 9/32"
80117	1/4" Drive 6 Point Deep SAE Socket 1/4"	80214	1/4" Drive 12 Point Standard SAE Socket 5/16"
80118	1/4" Drive 6 Point Deep SAE Socket 9/32"	80215D	1/4" Drive 12 Point Standard SAE Socket 11/32"
80119	1/4" Drive 6 Point Deep SAE Socket 5/16"	80216	1/4" Drive 12 Point Standard SAE Socket 3/8"
80120D	1/4" Drive 6 Point Deep SAE Socket 11/32"	80217	1/4" Drive 12 Point Standard SAE Socket 7/16"
80121	1/4" Drive 6 Point Deep SAE Socket 3/8"	80218	1/4" Drive 12 Point Standard SAE Socket 1/2"

GEARWRENCH® 22 Pc. 1/4" Drive 6 and 12 Point Metric Standard and Deep Mechanics Tool Set

- Includes Storage Case
- Full Polish Chrome Sockets With Large Hard Stamp Size Markings
- 84 Tooth Full Polish Chrome Thin Profile Ratchet
- Knurled Full Polish Chrome Extensions
- 1/4" Socket Driver With Ergonomic Dual Material Handle
- Sockets Feature Surface Drive® Technology To Reduce Fastener Rounding
- Meets or Exceeds ASME B107.5M, B107.10



Cat. No.	UPC No.	Packaging	Product Weight
80327	099575803277	Boxed	3.04 lb

Cat. No.	Description	Cat. No.	Description
81011F	1/4" Drive Full Polish Teardrop Ratchet	80148	1/4" Drive 6 Point Deep Metric Socket 13mm
81128	1/4" Socket Driver	80149	1/4" Drive 6 Point Deep Metric Socket 14mm
81116	1/4" Drive Standard Extension 6"	80197	1/4" Drive 12 Point Standard Socket 4mm
81101	1/4" Drive Standard Extension 2"	80198	1/4" Drive 12 Point Standard Socket 5mm
80141	1/4" Drive 6 Point Deep Metric Socket 6mm	80200	1/4" Drive 12 Point Standard Socket 6mm
80142	1/4" Drive 6 Point Deep Metric Socket 7mm	80201	1/4" Drive 12 Point Standard Socket 7mm
80143	1/4" Drive 6 Point Deep Metric Socket 8mm	80202	1/4" Drive 12 Point Standard Socket 8mm
80144	1/4" Drive 6 Point Deep Metric Socket 9mm	80203	1/4" Drive 12 Point Standard Socket 9mm
80145	1/4" Drive 6 Point Deep Metric Socket 10mm	80204	1/4" Drive 12 Point Standard Socket 10mm
80146D	1/4" Drive 6 Point Deep Metric Socket 11mm	80205	1/4" Drive 12 Point Standard Socket 11mm
80147	1/4" Drive 6 Point Deep Metric Socket 12mm	80206	1/4" Drive 12 Point Standard Socket 12mm

1 / 4 "

3 RATCHETS / SOCKETS / DRIVE TOOLS / SETS

GEARWRENCH® 13 Pc. 1/4" Drive 6 Point SAE Mechanics Tool Set

- Full Polish Chrome Sockets With Large Hard Stamp Size Markings
- Includes Storage Case
- 84 Tooth Full Polish Chrome Thin Profile Ratchet
- Knurled Full Polish Chrome Extensions
- 1/4" Socket Driver With Ergonomic Dual Material Handle
- Sockets Feature Surface Drive® Technology To Reduce Fastener Rounding
- Meets or Exceeds ASME B107.1, B107.10



Cat. No.	UPC No.	Packaging	Product Weight
80324	099575803246	Boxed	1.17 lb

Cat. No.	Description	Cat. No.	Description
81011F	1/4" Drive Full Polish Teardrop Ratchet	80108	1/4" Drive 6 Point Standard SAE Socket 9/32"
81128	1/4" Socket Driver	80109	1/4" Drive 6 Point Standard SAE Socket 5/16"
81101	1/4" Drive Standard Extension 2"	80110	1/4" Drive 6 Point Standard SAE Socket 11/32"
81116	1/4" Drive Standard Extension 6"	80111	1/4" Drive 6 Point Standard SAE Socket 3/8"
80105	1/4" Drive 6 Point Standard SAE Socket 3/16"	80112	1/4" Drive 6 Point Standard SAE Socket 7/16"
80106	1/4" Drive 6 Point Standard SAE Socket 7/32"	80113D	1/4" Drive 6 Point Standard SAE Socket 1/2"
80107	1/4" Drive 6 Point Standard SAE Socket 1/4"		

GEARWRENCH® 14 Pc. 1/4" Drive 6 Point Metric Mechanics Tool Set

- Full Polish Chrome Sockets With Large Hard Stamp Size Markings
- Includes Storage Case
- 84 Tooth Full Polish Chrome Thin Profile Ratchet
- Knurled Full Polish Chrome Extensions
- 1/4" Socket Driver With Ergonomic Dual Material Handle
- Sockets Feature Surface Drive® Technology To Reduce Fastener Rounding
- Meets or Exceeds ASME B107.5M, B107.10



Cat. No.	UPC No.	Packaging	Product Weight
80326	099575803260	Boxed	1.74 lb

Cat. No.	Description	Cat. No.	Description
81011F	1/4" Drive Full Polish Teardrop Ratchet	80129	1/4" Drive 6 Point Standard Metric Socket 7mm
81128	1/4" Socket Driver	80130	1/4" Drive 6 Point Standard Metric Socket 8mm
81101	1/4" Drive Standard Extension 2"	80131D	1/4" Drive 6 Point Standard Metric Socket 9mm
81116	1/4" Drive Standard Extension 6"	80132	1/4" Drive 6 Point Standard Metric Socket 10mm
80125	1/4" Drive 6 Point Standard Metric Socket 4mm	80133	1/4" Drive 6 Point Standard Metric Socket 11mm
80126	1/4" Drive 6 Point Standard Metric Socket 5mm	80134	1/4" Drive 6 Point Standard Metric Socket 12mm
80128	1/4" Drive 6 Point Standard Metric Socket 6mm	80135D	1/4" Drive 6 Point Standard Metric Socket 13mm

1 / 4 "

3

RATCHETS / SOCKETS / DRIVE TOOLS / SETS

GEARWRENCH® 47 Pc. 1/4" Drive 6 Point SAE/Metric Standard and Deep Socket Set

- Surface Drive® Technology Reduces Fastener Rounding
- Chamfered Opening to Guide Fastener Into Socket
- Large Hard-Stamped Size Identification
- Double Line (SAE) and Knurled (Metric) Ring to Easily Identify Standard vs. Metric Sockets
- Full Polish Chrome Finish Cleans Easily and Resists Corrosion
- Meets or Exceeds ASME B107.1, B107.5M



Cat. No.	UPC No.	Packaging	Drive Type	Product Weight
80314D	099575803147	Boxed	6 Point	3.61 lb

Cat. No.	Description	Cat. No.	Description
80104D	1/4" Drive 6 Point Standard SAE Socket 5/32"	80128	1/4" Drive 6 Point Standard Metric Socket 6mm
80105	1/4" Drive 6 Point Standard SAE Socket 3/16"	80129	1/4" Drive 6 Point Standard Metric Socket 7mm
80106	1/4" Drive 6 Point Standard SAE Socket 7/32"	80130	1/4" Drive 6 Point Standard Metric Socket 8mm
80107	1/4" Drive 6 Point Standard SAE Socket 1/4"	80131D	1/4" Drive 6 Point Standard Metric Socket 9mm
80108	1/4" Drive 6 Point Standard SAE Socket 9/32"	80132	1/4" Drive 6 Point Standard Metric Socket 10mm
80109	1/4" Drive 6 Point Standard SAE Socket 5/16"	80133	1/4" Drive 6 Point Standard Metric Socket 11mm
80110	1/4" Drive 6 Point Standard SAE Socket 11/32"	80134	1/4" Drive 6 Point Standard Metric Socket 12mm
80111	1/4" Drive 6 Point Standard SAE Socket 3/8"	80135D	1/4" Drive 6 Point Standard Metric Socket 13mm
80112	1/4" Drive 6 Point Standard SAE Socket 7/16"	80136	1/4" Drive 6 Point Standard Metric Socket 14mm
80113D	1/4" Drive 6 Point Standard SAE Socket 1/2"	80137	1/4" Drive 6 Point Standard Metric Socket 15mm
80114D	1/4" Drive 6 Point Standard SAE Socket 9/16"	80138	1/4" Drive 6 Point Deep Metric Socket 4mm
80115	1/4" Drive 6 Point Deep SAE Socket 3/16"	80139	1/4" Drive 6 Point Deep Metric Socket 5mm
80116D	1/4" Drive 6 Point Deep SAE Socket 7/32"	80140	1/4" Drive 6 Point Deep Metric Socket 5.5mm
80117	1/4" Drive 6 Point Deep SAE Socket 1/4"	80141	1/4" Drive 6 Point Deep Metric Socket 6mm
80118	1/4" Drive 6 Point Deep SAE Socket 9/32"	80142	1/4" Drive 6 Point Deep Metric Socket 7mm
80119	1/4" Drive 6 Point Deep SAE Socket 5/16"	80143	1/4" Drive 6 Point Deep Metric Socket 8mm
80120D	1/4" Drive 6 Point Deep SAE Socket 11/32"	80144	1/4" Drive 6 Point Deep Metric Socket 9mm
80121	1/4" Drive 6 Point Deep SAE Socket 3/8"	80145	1/4" Drive 6 Point Deep Metric Socket 10mm
80122D	1/4" Drive 6 Point Deep SAE Socket 7/16"	80146D	1/4" Drive 6 Point Deep Metric Socket 11mm
80123	1/4" Drive 6 Point Deep SAE Socket 1/2"	80147	1/4" Drive 6 Point Deep Metric Socket 12mm
80124	1/4" Drive 6 Point Deep SAE Socket 9/16"	80148	1/4" Drive 6 Point Deep Metric Socket 13mm
80125	1/4" Drive 6 Point Standard Metric Socket 4mm	80149	1/4" Drive 6 Point Deep Metric Socket 14mm
80126	1/4" Drive 6 Point Standard Metric Socket 5mm	80150	1/4" Drive 6 Point Deep Metric Socket 15mm
80127	1/4" Drive 6 Point Standard Metric Socket 5.5mm		

1 / 4 "

3

RATCHETS / SOCKETS / DRIVE TOOLS / SETS

GEARWRENCH® 10 Pc. 1/4" Drive 6 Point SAE Standard Socket Set

- Surface Drive® Technology Reduces Fastener Rounding
- Chamfered Opening to Guide Fastener Into Socket
- Large Hard-Stamped Size Identification
- Double Line (SAE) and Knurled (Metric) Ring to Easily Identify Standard vs. Metric Sockets
- Full Polish Chrome Finish Cleans Easily and Resists Corrosion
- Meets or Exceeds ASME B107.1



Cat. No.	UPC No.	Packaging	Drive Type	Product Weight
80303	099575803031	Carded	6 Point	0.55 lb

Cat. No.	Description	Cat. No.	Description
80105	1/4" Drive 6 Point Standard SAE Socket 3/16"	80110	1/4" Drive 6 Point Standard SAE Socket 11/32"
80106	1/4" Drive 6 Point Standard SAE Socket 7/32"	80111	1/4" Drive 6 Point Standard SAE Socket 3/8"
80107	1/4" Drive 6 Point Standard SAE Socket 1/4"	80112	1/4" Drive 6 Point Standard SAE Socket 7/16"
80108	1/4" Drive 6 Point Standard SAE Socket 9/32"	80113D	1/4" Drive 6 Point Standard SAE Socket 1/2"
80109	1/4" Drive 6 Point Standard SAE Socket 5/16"	80114D	1/4" Drive 6 Point Standard SAE Socket 9/16"

GEARWRENCH® 10 Pc. 1/4" Drive 6 Point SAE Mid Length Socket Set

- Mid Length Design for Access to Difficult Fasteners
- Surface Drive® Technology Reduces Fastener Rounding
- Chamfered Opening to Guide Fastener Into Socket
- Large Hard-Stamped Size Identification
- Double Line (SAE) and Knurled (Metric) Ring to Easily Identify Standard vs. Metric Sockets
- Full Polish Chrome Finish Cleans Easily and Resists Corrosion
- Meets or Exceeds ASME B107.1



Cat. No.	UPC No.	Packaging	Drive Type	Product Weight
80305S	099575833052	Carded	6 Point	0.59 lb

Cat. No.	Description	Cat. No.	Description
80115S	1/4" Drive 6 Point Mid Length SAE Socket 3/16"	80120S	1/4" Drive 6 Point Mid Length SAE Socket 11/32"
80116S	1/4" Drive 6 Point Mid Length SAE Socket 7/32"	80121S	1/4" Drive 6 Point Mid Length SAE Socket 3/8"
80117S	1/4" Drive 6 Point Mid Length SAE Socket 1/4"	80122S	1/4" Drive 6 Point Mid Length SAE Socket 7/16"
80118S	1/4" Drive 6 Point Mid Length SAE Socket 9/32"	80123S	1/4" Drive 6 Point Mid Length SAE Socket 1/2"
80119S	1/4" Drive 6 Point Mid Length SAE Socket 5/16"	80124S	1/4" Drive 6 Point Mid Length SAE Socket 9/16"

GEARWRENCH® 10 Pc. 1/4" Drive 12 Point SAE Standard Socket Set

- Surface Drive® Technology Reduces Fastener Rounding
- Chamfered Opening to Guides Fastener Into Socket
- Large Hard-Stamped Size Identification
- Double Line (SAE) and Knurled (Metric) Ring to Easily Identify Standard vs. Metric Sockets
- Full Polish Chrome Finish Cleans Easily and Resists Corrosion
- Meets or Exceeds ASME B107.1



Cat. No.	UPC No.	Packaging	Drive Type	Product Weight
80307D	099575803079	Carded	12 Point	0.55 lb

Cat. No.	Description	Cat. No.	Description
80210	1/4" Drive 12 Point Standard SAE Socket 3/16"	80215D	1/4" Drive 12 Point Standard SAE Socket 11/32"
80211	1/4" Drive 12 Point Standard SAE Socket 7/32"	80216	1/4" Drive 12 Point Standard SAE Socket 3/8"
80212	1/4" Drive 12 Point Standard SAE Socket 1/4"	80217	1/4" Drive 12 Point Standard SAE Socket 7/16"
80213	1/4" Drive 12 Point Standard SAE Socket 9/32"	80218	1/4" Drive 12 Point Standard SAE Socket 1/2"
80214	1/4" Drive 12 Point Standard SAE Socket 5/16"	80219	1/4" Drive 12 Point Standard SAE Socket 9/16"

GEARWRENCH® 10 Pc. 1/4" Drive 6 Point SAE Deep Socket Set

- Surface Drive® Technology Reduces Fastener Rounding
- Chamfered Opening to Guides Fastener Into Socket
- Large Hard-Stamped Size Identification
- Double Line (SAE) and Knurled (Metric) Ring to Easily Identify Standard vs. Metric Sockets
- Full Polish Chrome Finish Cleans Easily and Resists Corrosion
- Meets or Exceeds ASME B107.1



Cat. No.	UPC No.	Packaging	Drive Type	Product Weight
80305	099575803055	Carded	6 Point	0.97 lb

Cat. No.	Description	Cat. No.	Description
80115	1/4" Drive 6 Point Deep SAE Socket 3/16"	80120D	1/4" Drive 6 Point Deep SAE Socket 11/32"
80116D	1/4" Drive 6 Point Deep SAE Socket 7/32"	80121	1/4" Drive 6 Point Deep SAE Socket 3/8"
80117	1/4" Drive 6 Point Deep SAE Socket 1/4"	80122D	1/4" Drive 6 Point Deep SAE Socket 7/16"
80118	1/4" Drive 6 Point Deep SAE Socket 9/32"	80123	1/4" Drive 6 Point Deep SAE Socket 1/2"
80119	1/4" Drive 6 Point Deep SAE Socket 5/16"	80124	1/4" Drive 6 Point Deep SAE Socket 9/16"

1 / 4 "

3

RATCHETS / SOCKETS / DRIVE TOOLS / SETS

GEARWRENCH® 10 Pc. 1/4" Drive 12 Point SAE Deep Socket Set

- Surface Drive® Technology Reduces Fastener Rounding
- Chamfered Opening to Guides Fastener Into Socket
- Large Hard-Stamped Size Identification
- Double Line (SAE) and Knurled (Metric) Ring to Easily Identify Standard vs. Metric Sockets
- Full Polish Chrome Finish Cleans Easily and Resists Corrosion
- Meets or Exceeds ASME B107.1



Cat. No.	UPC No.	Packaging	Drive Type	Product Weight
80309D	099575803093	Carded	12 Point	0.97 lb

Cat. No.	Description	Cat. No.	Description
80220	1/4" Drive 12 Point Deep Socket 3/16"	80225	1/4" Drive 12 Point Deep Socket 11/32"
80221	1/4" Drive 12 Point Deep Socket 7/32"	80226	1/4" Drive 12 Point Deep Socket 3/8"
80222	1/4" Drive 12 Point Deep Socket 1/4"	80227	1/4" Drive 12 Point Deep Socket 7/16"
80223D	1/4" Drive 12 Point Deep Socket 9/32"	80228	1/4" Drive 12 Point Deep Socket 1/2"
80224	1/4" Drive 12 Point Deep Socket 5/16"	80229	1/4" Drive 12 Point Deep Socket 9/16"

GEARWRENCH® 13 Pc. 1/4" Drive 6 Point Metric Standard Socket Set

- Surface Drive® Technology Reduces Fastener Rounding
- Chamfered Opening to Guide Fastener Into Socket
- Large Hard-Stamped Size Identification
- Double Line (SAE) and Knurled (Metric) Ring to Easily Identify Standard vs. Metric Sockets
- Full Polish Chrome Finish Cleans Easily and Resists Corrosion
- Meets or Exceeds ASME B107.5M



Cat. No.	UPC No.	Packaging	Drive Type	Product Weight
80302D	099575803024	Carded	6 Point	0.71 lb

Cat. No.	Description	Cat. No.	Description
80125	1/4" Drive 6 Point Standard Metric Socket 4mm	80132	1/4" Drive 6 Point Standard Metric Socket 10mm
80126	1/4" Drive 6 Point Standard Metric Socket 5mm	80133	1/4" Drive 6 Point Standard Metric Socket 11mm
80127	1/4" Drive 6 Point Standard Metric Socket 5.5mm	80134	1/4" Drive 6 Point Standard Metric Socket 12mm
80128	1/4" Drive 6 Point Standard Metric Socket 6mm	80135D	1/4" Drive 6 Point Standard Metric Socket 13mm
80129	1/4" Drive 6 Point Standard Metric Socket 7mm	80136	1/4" Drive 6 Point Standard Metric Socket 14mm
80130	1/4" Drive 6 Point Standard Metric Socket 8mm	80137	1/4" Drive 6 Point Standard Metric Socket 15mm
80131D	1/4" Drive 6 Point Standard Metric Socket 9mm		

GEARWRENCH® 13 Pc. 1/4" Drive 6 Point Metric Mid Length Socket Set

- Mid Length Design for Access to Difficult Fasteners
- Surface Drive® Technology Reduces Fastener Rounding
- Chamfered Opening to Guide Fastener Into Socket
- Large Hard-Stamped Size Identification
- Double Line (SAE) and Knurled (Metric) Ring to Easily Identify Standard vs. Metric Sockets
- Full Polish Chrome Finish Cleans Easily and Resists Corrosion
- Meets or Exceeds ASME B107.5M



Cat. No.	UPC No.	Packaging	Drive Type	Product Weight
80304S	099575833045	Carded	6 Point	0.82 lb

Cat. No.	Description	Cat. No.	Description
80138S	1/4" Drive 6 Point Mid Length Metric Socket 4mm	80145S	1/4" Drive 6 Point Mid Length Metric Socket 10mm
80139S	1/4" Drive 6 Point Mid Length Metric Socket 5mm	80146S	1/4" Drive 6 Point Mid Length Metric Socket 11mm
80140S	1/4" Drive 6 Point Mid Length Metric Socket 5.5mm	80147S	1/4" Drive 6 Point Mid Length Metric Socket 12mm
80141S	1/4" Drive 6 Point Mid Length Metric Socket 6mm	80148S	1/4" Drive 6 Point Mid Length Metric Socket 13mm
80142S	1/4" Drive 6 Point Mid Length Metric Socket 7mm	80149S	1/4" Drive 6 Point Mid Length Metric Socket 14mm
80143S	1/4" Drive 6 Point Mid Length Metric Socket 8mm	80150S	1/4" Drive 6 Point Mid Length Metric Socket 15mm
80144S	1/4" Drive 6 Point Mid Length Metric Socket 9mm		

GEARWRENCH® 13 Pc. 1/4" Drive 12 Point Metric Standard Socket Set

- Surface Drive® Technology Reduces Fastener Rounding
- Chamfered Opening to Guide Fastener Into Socket
- Large Hard-Stamped Size Identification
- Double Line (SAE) and Knurled (Metric) Ring to Easily Identify Standard vs. Metric Sockets
- Full Polish Chrome Finish Cleans Easily and Resists Corrosion
- Meets or Exceeds ASME B107.5M



Cat. No.	UPC No.	Packaging	Drive Type	Product Weight
80306	099575803062	Carded	12 Point	0.70 lb

Cat. No.	Description	Cat. No.	Description
80197	1/4" Drive 12 Point Standard Socket 4mm	80204	1/4" Drive 12 Point Standard Socket 10mm
80198	1/4" Drive 12 Point Standard Socket 5mm	80205	1/4" Drive 12 Point Standard Socket 11mm
80199	1/4" Drive 12 Point Standard Socket 5.5mm	80206	1/4" Drive 12 Point Standard Socket 12mm
80200	1/4" Drive 12 Point Standard Socket 6mm	80207	1/4" Drive 12 Point Standard Socket 13mm
80201	1/4" Drive 12 Point Standard Socket 7mm	80208	1/4" Drive 12 Point Standard Socket 14mm
80202	1/4" Drive 12 Point Standard Socket 8mm	80209	1/4" Drive 12 Point Standard Socket 15mm
80203	1/4" Drive 12 Point Standard Socket 9mm		

1 / 4 "

3

RATCHETS / SOCKETS / DRIVE TOOLS / SETS

GEARWRENCH® 13 Pc. 1/4" Drive 6 Point Metric Deep Socket Set

- Surface Drive® Technology Reduces Fastener Rounding
- Chamfered Opening to Guide Fastener Into Socket
- Large Hard-Stamped Size Identification
- Double Line (SAE) and Knurled (Metric) Ring to Easily Identify Standard vs. Metric Sockets
- Full Polish Chrome Finish Cleans Easily and Resists Corrosion
- Meets or Exceeds ASME B107.5M



Cat. No.	UPC No.	Packaging	Drive Type	Product Weight
80304	099575803048	Carded	6 Point	1.28 lb

Cat. No.	Description	Cat. No.	Description
80138	1/4" Drive 6 Point Deep Metric Socket 4mm	80145	1/4" Drive 6 Point Deep Metric Socket 10mm
80139	1/4" Drive 6 Point Deep Metric Socket 5mm	80146D	1/4" Drive 6 Point Deep Metric Socket 11mm
80140	1/4" Drive 6 Point Deep Metric Socket 5.5mm	80147	1/4" Drive 6 Point Deep Metric Socket 12mm
80141	1/4" Drive 6 Point Deep Metric Socket 6mm	80148	1/4" Drive 6 Point Deep Metric Socket 13mm
80142	1/4" Drive 6 Point Deep Metric Socket 7mm	80149	1/4" Drive 6 Point Deep Metric Socket 14mm
80143	1/4" Drive 6 Point Deep Metric Socket 8mm	80150	1/4" Drive 6 Point Deep Metric Socket 15mm
80144	1/4" Drive 6 Point Deep Metric Socket 9mm		

GEARWRENCH® 13 Pc. 1/4" Drive 12 Point Metric Deep Socket Set

- Surface Drive® Technology Reduces Fastener Rounding
- Chamfered Opening to Guide Fastener Into Socket
- Large Hard-Stamped Size Identification
- Double Line (SAE) and Knurled (Metric) Ring to Easily Identify Standard vs. Metric Sockets
- Full Polish Chrome Finish Cleans Easily and Resists Corrosion
- Meets or Exceeds ASME B107.5M



Cat. No.	UPC No.	Packaging	Drive Type	Product Weight
80308	099575803086	Carded	12 Point	1.28 lb

Cat. No.	Description	Cat. No.	Description
80230	1/4" Drive 12 Point Deep Socket 4mm	80237	1/4" Drive 12 Point Deep Socket 10mm
80231	1/4" Drive 12 Point Deep Socket 5mm	80238	1/4" Drive 12 Point Deep Socket 11mm
80232	1/4" Drive 12 Point Deep Socket 5.5mm	80239D	1/4" Drive 12 Point Deep Socket 12mm
80233	1/4" Drive 12 Point Deep Socket 6mm	80240	1/4" Drive 12 Point Deep Socket 13mm
80234	1/4" Drive 12 Point Deep Socket 7mm	80241	1/4" Drive 12 Point Deep Socket 14mm
80235	1/4" Drive 12 Point Deep Socket 8mm	80242	1/4" Drive 12 Point Deep Socket 15mm
80236	1/4" Drive 12 Point Deep Socket 9mm		

GEARWRENCH® 7 Pc. 1/4" Drive 6 Point SAE Flex Socket Set

- Large Hard-Stamped Identification
- Entry Angle Guides Fastener
- Full Polish Chrome Finish



Cat. No.	UPC No.	Packaging	Product Weight
80310D	099575803109	Carded	1.20 lb

Cat. No.	Description	Cat. No.	Description
80262	1/4" Drive 6 Point Flex Socket 3/16"	80266	1/4" Drive 6 Point Flex Socket 7/16"
80263D	1/4" Drive 6 Point Flex Socket 1/4"	80267	1/4" Drive 6 Point Flex Socket 1/2"
80264	1/4" Drive 6 Point Flex Socket 5/16"	80268	1/4" Drive 6 Point Flex Socket 9/16"
80265	1/4" Drive 6 Point Flex Socket 3/8"		

GEARWRENCH® 12 Pc. 1/4" Drive 6 Point Metric Flex Socket Set

- Large Hard-Stamped Identification
- Entry Angle Guides Fastener
- Full Polish Chrome Finish



Cat. No.	UPC No.	Packaging	Product Weight
80311	099575803116	Carded	2.50 lb

Cat. No.	Description	Cat. No.	Description
80250	1/4" Drive 6 Point Flex Socket 5mm	80256	1/4" Drive 6 Point Flex Socket 10mm
80251D	1/4" Drive 6 Point Flex Socket 5.5mm	80257	1/4" Drive 6 Point Flex Socket 11mm
80252	1/4" Drive 6 Point Flex Socket 6mm	80258	1/4" Drive 6 Point Flex Socket 12mm
80253	1/4" Drive 6 Point Flex Socket 7mm	80259	1/4" Drive 6 Point Flex Socket 13mm
80254	1/4" Drive 6 Point Flex Socket 8mm	80260	1/4" Drive 6 Point Flex Socket 14mm
80255	1/4" Drive 6 Point Flex Socket 9mm	80261	1/4" Drive 6 Point Flex Socket 15mm

GEARWRENCH® 10 Pc. 1/4" Drive SAE Hex Bit Socket Set

- Heat Treated Socket Bases for Durability and Serviceability
- Professional, Full Polish Chrome
- Includes Socket Rail
- Meets or Exceeds ASME B107.1



Cat. No.	UPC No.	Packaging	Product Weight
80323	099575803239	Carded	0.67 lb

Cat. No.	Description	Cat. No.	Description
80151D	1/4" Drive Hex Bit Socket, 1/16"	80156	1/4" Drive Hex Bit Socket, 9/64"
80152	1/4" Drive Hex Bit Socket, 5/64"	80157	1/4" Drive Hex Bit Socket, 5/32"
80153	1/4" Drive Hex Bit Socket, 3/32"	80158	1/4" Drive Hex Bit Socket, 3/16"
80154	1/4" Drive Hex Bit Socket, 7/64"	80159	1/4" Drive Hex Bit Socket, 7/32"
80155	1/4" Drive Hex Bit Socket, 1/8"	80160	1/4" Drive Hex Bit Socket, 1/4"

1 / 4 "

3

RATCHETS / SOCKETS / DRIVE TOOLS / SETS

GEARWRENCH® 6 Pc. 1/4" Drive Metric Hex Bit Socket Set

- Heat Treated Socket Bases for Durability and Serviceability
- Professional, Full Polish Chrome
- Includes Socket Rail
- Meets or Exceeds ASME B107.5M



Cat. No.	UPC No.	Packaging	Product Weight
80321	099575803215	Carded	0.43 lb

Cat. No.	Description	Cat. No.	Description
80161	1/4" Drive Hex Bit Socket, 2mm	80164	1/4" Drive Hex Bit Socket, 4mm
80162	1/4" Drive Hex Bit Socket, 2.5mm	80165	1/4" Drive Hex Bit Socket, 5mm
80163	1/4" Drive Hex Bit Socket, 3mm	80166	1/4" Drive Hex Bit Socket, 6mm

GEARWRENCH® 6 Pc. 1/4" Drive External Torx® Deep Socket Set

- Heat Treated Socket Bases for Durability and Serviceability
- Professional, Full Polish Chrome
- Includes Socket Rail



Cat. No.	UPC No.	Packaging	Product Weight
80322	099575803222	Carded	0.46 lb

Cat. No.	Description	Cat. No.	Description
80191	1/4" Drive Deep External TORX® Socket, E-4	80194	1/4" Drive Deep External TORX® Socket, E-7
80192	1/4" Drive Deep External TORX® Socket, E-5	80195	1/4" Drive Deep External TORX® Socket, E-8
80193	1/4" Drive Deep External TORX® Socket, E-6	80196	1/4" Drive Deep External TORX® Socket, E-10

GEARWRENCH® 4 Pc. 1/4" Drive Metric Triple Square Bit Socket Set

- Heat Treated Socket Bases for Durability and Serviceability
- Professional, Full Polish Chrome
- Includes Socket Rail
- Meets or Exceeds ASME B107.5M



Cat. No.	UPC No.	Packaging	Product Weight
80320	099575803208	Carded	0.37 lb

Cat. No.	Description	Cat. No.	Description
80167	1/4" Drive Triple Square Bit Socket, 4mm	80169	1/4" Drive Triple Square Bit Socket, 6mm
80168	1/4" Drive Triple Square Bit Socket, 5mm	80170D	1/4" Drive Triple Square Bit Socket, 8mm

GEARWRENCH 1/4" Drive 120XP™ Teardrop Ratchet



- 120 Positions, 3° Ratcheting Arc
- The Gear is Alternately Engaged by the Double-Stacked Pawls which give a 3° Swing Arc for Faster Work
- Highly Visible On/Off Markings on the Head
- Enclosed Head Design for Extreme Resistance to Dirt Infiltration
- Double-Stacked Pawls Engage a 60-tooth Gear Providing Exceptional Strength, Exceeding ASME Specifications
- Teardrop Low Profile Head and Flush Mounted On/Off Switch Allow Better Access in Tight Spaces
- Longer Reach Handle to Access Hard to Reach Fasteners
- Full Polish Chrome Handle
- Meets or Exceeds ASME B107.10



Cat. No.	UPC No.	Overall Length	Head Width	Head Thickness	No. of Positions	Repair Kit	Product Weight
81011P	099575810176	5.118 in	0.94 in	0.36 in	120	81099P	0.29 lb

GEARWRENCH 1/4" Drive 120XP™ Full Polish Flex Teardrop Ratchet



- 120 Positions, 3° Ratcheting Arc
- The Gear is Alternately Engaged by the Double-Stacked Pawls which give a 3° Swing Arc for Faster Work
- 6-Position Flex Head for Adjustable Access Angle
- Highly Visible On/Off Markings on the Head
- Enclosed Head Design for Extreme Resistance to Dirt Infiltration
- Double-Stacked Pawls Engage a 60-tooth Gear Providing Exceptional Strength, Exceeding ASME Specifications
- Teardrop Low Profile Head and Flush Mounted On/Off Switch Allow Better Access in Tight Spaces
- Longer Reach Handle to Access Hard to Reach Fasteners
- Full Polish Chrome Handle
- Meets or Exceeds ASME B107.10



Cat. No.	UPC No.	Packaging	Overall Length	Head Width	Head Thickness	No. of Positions	Repair Kit	Product Weight
81012P	099575080128	Carded	6.85 in	1.02 in	0.41 in	120	81099P	0.33 lb

GEARWRENCH 1/4" Drive Full Polish Teardrop Ratchet

- Flush Mounted On-Off Lever
- Teardrop Shaped Head
- Full Polish Chrome Handle
- Bright Chrome Finish
- Meets or Exceeds ASME B107.10



Cat. No.	UPC No.	Packaging	Overall Length	Head Width	Head Thickness	Tooth Count	Repair Kit	Product Weight
81011F	099575811111	Carded	5.130 in	0.98 in	0.35 in	84	81099F	0.27 lb

1 / 4 " 3 RATCHETS / SOCKETS / DRIVE TOOLS / SETS

GEARWRENCH 1/4" Drive Long Handle Full Polish Teardrop Ratchet

- Full Polish Chrome, Long Handle for Increased Access
- Flush Mounted On-Off Lever
- Teardrop Shaped Head
- Full Polish Chrome Finish
- Meets or Exceeds ASME B107.10



Cat. No.	UPC No.	Packaging	Overall Length	Head Width	Head Thickness	Tooth Count	Repair Kit	Product Weight
81028	099575810282	Carded	6.87 in	0.96 in	0.35 in	84	81099F	0.28 lb

GEARWRENCH 1/4" Drive Full Polish Flex Teardrop Ratchet

- Flush Mounted On-Off Lever
- Teardrop Shaped Head
- Full Polish Chrome Handle
- Bright Chrome Finish
- Meets or Exceeds ASME B107.10



Cat. No.	UPC No.	Packaging	Overall Length	Head Width	Head Thickness	Tooth Count	Repair Kit	Product Weight
81012F	099575811128	Carded	6.970 in	0.98 in	0.35 in	84	81099F	0.32 lb

GEARWRENCH 1/4" Drive Quick Release Teardrop Ratchet

- Quick-Release Drive Tool Retention
- Teardrop Shaped Head
- Full Polish Chrome Handle
- Bright Chrome Finish
- Meets or Exceeds ASME B107.10



Cat. No.	UPC No.	Packaging	Overall Length	Head Width	Head Thickness	Tooth Count	Repair Kit	Product Weight
81014	099575810145	Carded	5.630 in	1.00 in	0.47 in	45		0.30 lb

GEARWRENCH 1/4" Drive Cushion Grip Teardrop Ratchet

- Flush Mounted On-Off Lever
- Teardrop Shaped Head
- Dual Material Comfort Grip Handle
- Bright Chrome Finish
- Meets or Exceeds ASME B107.10



Cat. No.	UPC No.	Packaging	Overall Length	Head Width	Head Thickness	Tooth Count	Repair Kit	Product Weight
81007F	099575811074	Carded	6.420 in	0.98 in	0.35 in	84	81099F	0.34 lb

GEARWRENCH 1/4" Drive Long Handle Cushion Grip Teardrop Ratchet

- Dual Material Comfort Grip, Long Handle for Increased Access
- Flush Mounted On-Off Lever
- Teardrop Shaped Head
- Full Polish Chrome Finish
- Meets or Exceeds ASME B107.10

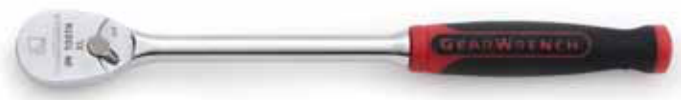

Cat. No.	UPC No.	Packaging	Overall Length	Head Width	Head Thickness	Tooth Count	Repair Kit	Product Weight
81029	099575810299	Carded	8.18 in	0.98 in	0.35 in	84	81099F	0.28 lb

GEARWRENCH® 1/4" Drive Cushion Grip Flex Teardrop Ratchet

- Flush Mounted On-Off Lever
- Teardrop Shaped Head
- Dual Material Comfort Grip Handle
- Bright Chrome Finish
- Meets or Exceeds ASME B107.10



Cat. No.	UPC No.	Packaging	Overall Length	Head Width	Head Thickness	Tooth Count	Repair Kit	Product Weight
81009F	099575811098	Carded	7.760 in	0.98 in	0.35 in	84	81099F	0.39 lb

GEARWRENCH® 1/4" Drive 120XP™ Cushion Grip Teardrop Flex Head Ratchet



- 120 Positions, 3° Ratcheting Arc
- The Gear is Alternately Engaged by the Double-Stacked Pawls which give a 3° Swing Arc for Faster Work
- 6-Position Flex Head for Adjustable Access Angle
- Highly Visible On/Off Markings on the Head
- Enclosed Head Design for Extreme Resistance to Dirt Infiltration
- Double-Stacked Pawls Engage a 60-tooth Gear Providing Exceptional Strength, Exceeding ASME Specifications
- Teardrop Low Profile Head and Flush Mounted On/Off Switch Allow Better Access in Tight Spaces
- Longer Reach Handle to Access Hard to Reach Fasteners
- Dual Material Comfort Grip Handle
- Meets or Exceeds ASME B107.10



Cat. No.	UPC No.	Packaging	Overall Length	Head Width	Head Thickness	No. of Positions	Repair Kit	Product Weight
81009P	099575010095	Carded	8.18 in	1.01 in	0.41 in	120	81099P	0.33 lb

GEARWRENCH® 1/4" Drive Cushion Grip Roto Ratchet

- 360 Degree Rotating Head for Speed and Access
- Round Shaped Head
- Dual Material Comfort Grip Handle
- Bright Chrome Finish
- Meets or Exceeds ASME B107.10M



Cat. No.	UPC No.	Packaging	Overall Length	Head Width	Head Thickness	Tooth Count	Product Weight
81224	099575812248	Carded	6.75 in	1.25 in	0.59 in	72	0.36 lb

GEARWRENCH® 1/4" Drive Ratchet Repair Kits

- For Non-Quick Release and Non-Roto Ratchets



Cat. No.	UPC No.	Packaging	Description	Fits Product Number	Tooth Count	No. of Positions	Product Weight
81099F	099575811999	Bagged	1/4" Drive Non-Quick Release Ratchet Repair Kit 84 Tooth	81011, 81012, 81007, 81009, 81011F, 81012F, 81007F, 81009F	84	-	0.04 lb
81099P	099575891991	Bagged	1/4" Drive Non-Quick Release Ratchet Repair Kit Dual Pawl 120XP	81009P, 81011P, 81012P	-	120	0.06 lb

1 / 4 "

3

RATCHETS / SOCKETS / DRIVE TOOLS / SETS

GEARWRENCH® 1/4" Drive Gimbal Ratchet

- Gimbal Design Allows Ratchet to Pivot in Two Directions for Easier Access
- 72-Tooth Ratcheting Mechanism for 5 Degree Swing Arc
- Anodised Aluminum Finish
- Easy to Use Forward/Reverse Lever
- Meets or Exceeds ASME Performance Requirements



Cat. No.	UPC No.	Packaging	Tooth Count	Product Weight
81027	099575810275	Carded	72	0.20 lb

GEARWRENCH® 1/4" Drive Thumbwheel Ratchet

- 72 - Tooth Gear for 5 Degree Ratchet Angle
- Reversing Lever
- Contoured Handle for Maximum Grip Force



Cat. No.	UPC No.	Packaging	Tooth Count	Product Weight
81008	099575810084	Boxed	72	0.31 lb

GEARWRENCH® 1/4" Drive Spinner Handle

- Professional, Full Polish Finish
- Spinner Handle Designed for Ultra Fast Action



Cat. No.	UPC No.	Packaging	Length	Product Weight
81128	099575811289	Carded	7.75 in	0.30 lb

GEARWRENCH® 1/4" Drive Flex Handle / Breaker Bar



Cat. No.	UPC No.	Packaging	Overall Length	Product Weight
81013	099575810138	Carded	5.40	0.26 lb

GEARWRENCH® 1/4" Drive Universal Joint

- Universal Joint Allows for Greater Access
- Full Polish Chrome Finish



Cat. No.	UPC No.	Packaging	Overall Length	Female Drive Size	Male Drive Size	Product Weight
80100	099575801006	Carded	1.375 in	1/4"	1/4"	0.04 lb

GEARWRENCH® 1/4" Drive Magnetic Universal Joint

- Strong Magnetic Tips Allow for Contact Through the Base of the Socket to Hold Nuts and Bolts in Place During Use
- Universal Joint Allows for Greater Access



Cat. No.	UPC No.	Packaging	Overall Length	Female Drive Size	Male Drive Size	Product Weight
81255	099575812552	Carded	1.75 in	1/4"	1/4"	0.20 lb

GEARWRENCH® 1/4" Drive Adapter

- Full Polish Chrome Finish



Cat. No.	UPC No.	Packaging	Description	Overall Length	Female Drive Size	Male Drive Size	Product Weight
81127	099575811272	Carded	1/4" Drive 1/4" F x 3/8" M Adapter	1.00 in	1/4"	3/8"	0.04 lb

GEARWRENCH® 1/4" Drive Magnetic Adapter

- Magnetic Tip Keeps the Fastener in the Sockets
- Full Polish Chrome Finish



Cat. No.	UPC No.	Packaging	Description	Female Drive Size	Male Drive Size	Product Weight
81258	099575812583	Carded	1/4" Drive 1/4" F x 3/8" M Adapter, Magnetic	1/4"	3/8"	0.20 lb

1 / 4 "

3

RATCHETS / SOCKETS / DRIVE TOOLS / SETS

GEARWRENCH® 5 Pc. 1/4" Drive Standard Extension Set

- Knurled Grip Provides Non-Slip Surface
- Full Polish Chrome Finish



Cat. No.	UPC No.	Packaging	Product Weight
81002D	099575810022	Carded	0.99 lb

Cat. No.	Description	Cat. No.	Description
81101	1/4" Drive Standard Extension 2"	81116	1/4" Drive Standard Extension 6"
81113D	1/4" Drive Standard Extension 3"	81118	1/4" Drive Standard Extension 14"
81114D	1/4" Drive Standard Extension 4"		

GEARWRENCH® 1/4" Drive Standard Extensions

- Knurled Grip Provides Non-Slip Surface
- Full Polish Chrome Finish



Cat. No.	UPC No.	Packaging	Length	Wobble	Product Weight
81101	099575811012	Carded	2 in	No	0.04 lb
81113D	099575811135	Carded	3 in	No	0.07 lb
81114D	099575811142	Carded	4 in	No	0.09 lb
81116	099575811166	Carded	6 in	No	0.15 lb
81117D	099575811173	Carded	10 in	No	0.38 lb
81118	099575811180	Carded	14 in	No	0.31 lb

GEARWRENCH® 1/4" Drive Magnetic Extension

- Knurled Grip Provides Non-Slip Surface
- Strong Magnetic Tips Allow for Contact Through the Base of the Socket to Hold Nuts and Bolts in Place During Use
- Full Polish Chrome Finish



Cat. No.	UPC No.	Packaging	Length	Wobble	Product Weight
81261	099575812613	Carded	6 in	No	0.70 lb

GEARWRENCH® 4 Pc. 1/4" Drive Wobble Extension Set

- Use as either Standard Extension when Fully Inserted in Socket or as a Wobble Extension when Partially Inserted
- Knurled Grip Provides Non-Slip Surface
- Full Polish Chrome Finish



Cat. No.	UPC No.	Packaging	Product Weight
81004D	099575810046	Carded	0.83 lb

Cat. No.	Description	Cat. No.	Description
81119	1/4" Drive Wobble Extension 2"	81121	1/4" Drive Wobble Extension 6"
81120	1/4" Drive Wobble Extension 4"	81122	1/4" Drive Wobble Extension 14"

GEARWRENCH® 1/4" Drive Wobble Extensions

- Use as either Standard Extension when Fully Inserted in Socket or as a Wobble Extension when Partially Inserted
- Knurled Grip Provides Non-Slip Surface
- Full Polish Chrome Finish



Cat. No.	UPC No.	Packaging	Length	Wobble	Product Weight
81119	099575811197	Carded	2 in	Yes	0.04 lb
81120	099575811203	Carded	4 in	Yes	0.09 lb
81121	099575811210	Carded	6 in	Yes	0.15 lb
81122	099575811227	Carded	14 in	Yes	0.31 lb

GEARWRENCH® 3 Pc. 1/4" Drive Locking Extension Set

- Knurled Grip Provides Non-Slip Surface
- Full Polish Chrome Finish



Cat. No.	UPC No.	Packaging	Product Weight
81003	099575810039	Carded	0.35 lb

Cat. No.	Description	Cat. No.	Description
81123	1/4" Drive Locking Extension 2"	81126	1/4" Drive Locking Extension 6"
81124	1/4" Drive Locking Extension 3"		

GEARWRENCH® 1/4" Drive Locking Extensions

- Knurled Grip Provides Non-Slip Surface
- Full Polish Chrome Finish



Cat. No.	UPC No.	Packaging	Length	Wobble	Product Weight
81123	099575811234	Carded	2 in	No	0.04 lb
81124	099575811241	Carded	3 in	No	0.09 lb
81125	099575811258	Carded	4 in	No	0.15 lb
81126	099575811265	Carded	6 in	No	0.20 lb

GEARWRENCH® 1/4" Drive 6 and 12 Point SAE Standard Length Sockets

- Surface Drive® Technology Reduces Fastener Rounding
- Chamfered Opening to Guide Fastener Into Socket
- Large Hard-Stamped Size Identification
- Double Line (SAE) and Knurled (Metric) Ring to Easily Identify Standard vs. Metric Sockets
- Full Polish Chrome Finish Cleans Easily and Resists Corrosion
- Meets or Exceeds ASME B107.1 and US Federal Spec. GGG-W-641 E

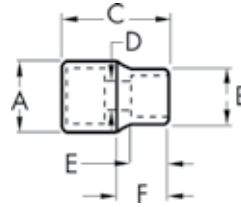

Cat. No.	UPC No.	Packaging	Drive Type	Fastener Size	Dim. A: Drive End	Dim. B: Wrench End	Dim. C: Overall Length	Dim. D: Bolt Clearance	Dim. E: Wrench Depth	Dim. F: Length to Shoulder	Product Weight
80104D	099575801044	Carded	6 Point	5/32 in	0.465 in	0.272 in	0.965 in	0.134 in	0.295 in	0.453 in	0.02 lb
80105	099575801051	Carded	6 Point	3/16 in	0.465 in	0.307 in	0.965 in	0.157 in	0.315 in	0.453 in	0.02 lb
80106	099575810060	Carded	6 Point	7/32 in	0.465 in	0.335 in	0.965 in	0.157 in	0.315 in	0.453 in	0.02 lb
80107	099575801075	Carded	6 Point	1/4 in	0.465 in	0.374 in	0.965 in	0.157 in	0.354 in	0.453 in	0.02 lb
80108	099575801082	Carded	6 Point	9/32 in	0.465 in	0.421 in	0.965 in	0.220 in	0.394 in	0.453 in	0.02 lb
80109	099575801099	Carded	6 Point	5/16 in	0.465 in	0.453 in	0.965 in	0.220 in	0.413 in	0.453 in	0.02 lb
80110	099575801105	Carded	6 Point	11/32 in	0.492 in	0.492 in	0.965 in	0.220 in	0.413 in	0.453 in	0.04 lb
80111	099575801112	Carded	6 Point	3/8 in	0.543 in	0.543 in	0.965 in	0.220 in	0.492 in	0.453 in	0.02 lb
80112	099575801129	Carded	6 Point	7/16 in	0.618 in	0.618 in	0.965 in	0.220 in	0.492 in	0.453 in	0.03 lb
80113D	099575801136	Carded	6 Point	1/2 in	0.681 in	0.681 in	0.965 in	0.220 in	0.492 in	0.453 in	0.03 lb
80114D	099575801143	Carded	6 Point	9/16 in	0.768 in	0.768 in	0.965 in	0.220 in	0.571 in	0.453 in	0.04 lb
80290	099575802904	Carded	12 Point	5/32 in	0.465 in	0.272 in	0.965 in	0.134 in	0.295 in	0.453 in	0.02 lb
80210	099575802102	Carded	12 Point	3/16 in	0.465 in	0.307 in	0.965 in	0.157 in	0.315 in	0.453 in	0.02 lb
80211	099575802119	Carded	12 Point	7/32 in	0.465 in	0.335 in	0.965 in	0.157 in	0.315 in	0.453 in	0.02 lb
80212	099575802126	Carded	12 Point	1/4 in	0.465 in	0.374 in	0.965 in	0.157 in	0.354 in	0.453 in	0.02 lb
80213	099575802133	Carded	12 Point	9/32 in	0.465 in	0.421 in	0.965 in	0.220 in	0.394 in	0.453 in	0.02 lb
80214	099575802140	Carded	12 Point	5/16 in	0.465 in	0.453 in	0.965 in	0.220 in	0.413 in	0.453 in	0.02 lb
80215D	099575802157	Carded	12 Point	11/32 in	0.492 in	0.492 in	0.965 in	0.220 in	0.413 in	0.453 in	0.03 lb
80216	099575802164	Carded	12 Point	3/8 in	0.543 in	0.543 in	0.965 in	0.220 in	0.492 in	0.453 in	0.03 lb
80217	099575802171	Carded	12 Point	7/16 in	0.618 in	0.618 in	0.965 in	0.220 in	0.492 in	0.453 in	0.04 lb
80218	099575802188	Carded	12 Point	1/2 in	0.681 in	0.681 in	0.965 in	0.220 in	0.492 in	0.453 in	0.06 lb
80219	099575802195	Carded	12 Point	9/16 in	0.768 in	0.768 in	0.965 in	0.220 in	0.571 in	0.453 in	0.06 lb

GEARWRENCH® 1/4" Drive 6 and 12 Point Metric Standard Length Sockets

- Surface Drive® Technology Reduces Fastener Rounding
- Chamfered Opening to Guide Fastener Into Socket
- Large Hard-Stamped Size Identification
- Double Line (SAE) and Knurled (Metric) Ring to Easily Identify Standard vs. Metric Sockets
- Full Polish Chrome Finish Cleans Easily and Resists Corrosion
- Meets or Exceeds ASME B107.5M

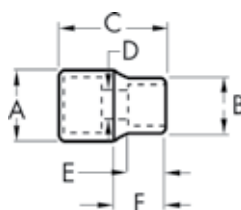

Cat. No.	UPC No.	Packaging	Drive Type	Fastener Size	Dim. A: Drive End	Dim. B: Wrench End	Dim. C: Overall Length	Dim. D: Bolt Clearance	Dim. E: Wrench Depth	Dim. F: Length to Shoulder	Product Weight
80125	099575801259	Carded	6 Point	4 mm	0.465 in	0.264 in	0.965 in	0.134 in	0.315 in	0.453 in	0.01 lb
80126	099575801266	Carded	6 Point	5 mm	0.465 in	0.315 in	0.965 in	0.157 in	0.315 in	0.453 in	0.02 lb
80127	099575801273	Carded	6 Point	5.5 mm	0.465 in	0.339 in	0.965 in	0.157 in	0.315 in	0.453 in	0.02 lb
80128	099575801280	Carded	6 Point	6 mm	0.465 in	0.362 in	0.965 in	0.157 in	0.354 in	0.453 in	0.02 lb
80129	099575801297	Carded	6 Point	7 mm	0.465 in	0.421 in	0.965 in	0.220 in	0.374 in	0.453 in	0.02 lb
80130	099575801303	Carded	6 Point	8 mm	0.465 in	0.453 in	0.965 in	0.220 in	0.394 in	0.453 in	0.02 lb
80131D	099575801310	Carded	6 Point	9 mm	0.516 in	0.516 in	0.965 in	0.220 in	0.413 in	0.453 in	0.02 lb
80132	099575801327	Carded	6 Point	10 mm	0.563 in	0.563 in	0.965 in	0.220 in	0.492 in	0.453 in	0.04 lb
80133	099575801334	Carded	6 Point	11 mm	0.622 in	0.622 in	0.965 in	0.220 in	0.492 in	0.453 in	0.03 lb
80134	099575801341	Carded	6 Point	12 mm	0.661 in	0.661 in	0.965 in	0.220 in	0.492 in	0.453 in	0.03 lb
80135D	099575801358	Carded	6 Point	13 mm	0.705 in	0.705 in	0.965 in	0.220 in	0.492 in	0.453 in	0.04 lb
80136	099575801365	Carded	6 Point	14 mm	0.768 in	0.768 in	0.965 in	0.220 in	0.571 in	0.453 in	0.04 lb
80137	099575801372	Carded	6 Point	15 mm	0.819 in	0.819 in	0.965 in	0.220 in	0.571 in	0.453 in	0.07 lb
80197	099575801976	Carded	12 Point	4 mm	0.465 in	0.264 in	0.965 in	0.134 in	0.315 in	0.453 in	0.02 lb
80198	099575801983	Carded	12 Point	5 mm	0.465 in	0.315 in	0.965 in	0.157 in	0.315 in	0.453 in	0.02 lb
80199	099575801990	Carded	12 Point	5.5 mm	0.465 in	0.339 in	0.965 in	0.157 in	0.315 in	0.453 in	0.02 lb
80200	099575802003	Carded	12 Point	6 mm	0.465 in	0.362 in	0.965 in	0.157 in	0.354 in	0.453 in	0.02 lb
80201	099575802010	Carded	12 Point	7 mm	0.465 in	0.421 in	0.965 in	0.220 in	0.374 in	0.453 in	0.02 lb
80202	099575802027	Carded	12 Point	8 mm	0.465 in	0.453 in	0.965 in	0.220 in	0.394 in	0.453 in	0.03 lb
80203	099575802034	Carded	12 Point	9 mm	0.516 in	0.516 in	0.965 in	0.220 in	0.413 in	0.453 in	0.03 lb
80204	099575802041	Carded	12 Point	10 mm	0.563 in	0.563 in	0.965 in	0.220 in	0.492 in	0.453 in	0.04 lb
80205	099575802058	Carded	12 Point	11 mm	0.622 in	0.622 in	0.965 in	0.220 in	0.492 in	0.453 in	0.04 lb
80206	099575802065	Carded	12 Point	12 mm	0.661 in	0.661 in	0.965 in	0.220 in	0.492 in	0.453 in	0.05 lb
80207	099575802072	Carded	12 Point	13 mm	0.705 in	0.705 in	0.965 in	0.220 in	0.492 in	0.453 in	0.06 lb
80208	099575802089	Carded	12 Point	14 mm	0.768 in	0.768 in	0.965 in	0.220 in	0.571 in	0.453 in	0.06 lb
80209	099575802096	Carded	12 Point	15 mm	0.819 in	0.819 in	0.965 in	0.220 in	0.571 in	0.453 in	0.07 lb

1 / 4 "

3

RATCHETS / SOCKETS / DRIVE TOOLS / SETS

GEARWRENCH® 1/4" Drive 6 Point SAE Mid Length Sockets

- Surface Drive® Technology Reduces Fastener Rounding
- Chamfered Opening To Guides Fastener Into Socket
- Large Hard-Stamped Size Identification
- Double Line (SAE) and Knurled (Metric) Ring To Easily Identify Standard vs. Metric Sockets
- Full Polish Chrome Finish Cleans Easily and Resists Corrosion
- Meets or Exceeds ASME B107.1

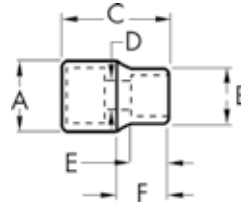

Cat. No.	UPC No.	Packaging	Drive Type	Fastener Size	Dim. A: Drive End	Dim. B: Wrench End	Dim. C: Overall Length	Dim. D: Bolt Clearance	Dim. E: Wrench Depth	Dim. F: Length to Shoulder	Product Weight
80115S	099575851155	Carded	6 Point	3/16 in	0.46 in	0.30 in	1.25 in	0.12 in	0.31 in	0.64 in	0.03 lb
80116S	099575831164	Carded	6 Point	7/32 in	0.46 in	0.34 in	1.25 in	0.16 in	0.47 in	0.64 in	0.03 lb
80117S	099575831171	Carded	6 Point	1/4 in	0.46 in	0.37 in	1.25 in	0.18 in	0.51 in	0.64 in	0.03 lb
80118S	099575831188	Carded	6 Point	9/32 in	0.46 in	0.42 in	1.25 in	0.20 in	0.51 in	0.64 in	0.03 lb
80119S	099575831195	Carded	6 Point	5/16 in	0.46 in	0.46 in	1.25 in	0.20 in	0.53 in	-	0.03 lb
80120S	099575851209	Carded	6 Point	11/32 in	0.50 in	0.50 in	1.25 in	0.24 in	0.53 in	-	0.04 lb
80121S	099575831218	Carded	6 Point	3/8 in	0.57 in	0.57 in	1.25 in	0.30 in	0.53 in	-	0.05 lb
80122S	099575821226	Carded	6 Point	7/16 in	0.55 in	0.62 in	1.25 in	0.35 in	0.57 in	-	0.06 lb
80123S	099575821233	Carded	6 Point	1/2 in	0.63 in	0.70 in	1.25 in	0.39 in	0.57 in	-	0.07 lb
80124S	099575821240	Carded	6 Point	9/16 in	0.71 in	0.78 in	1.25 in	0.47 in	0.57 in	-	0.09 lb

GEARWRENCH® 1/4" Drive 6 Point Metric Mid Length Sockets

- Surface Drive® Technology Reduces Fastener Rounding
- Chamfered Opening To Guides Fastener Into Socket
- Large Hard-Stamped Size Identification
- Double Line (SAE) and Knurled (Metric) Ring To Easily Identify Standard vs. Metric Sockets
- Full Polish Chrome Finish Cleans Easily and Resists Corrosion
- Meets or Exceeds ASME B107.5M

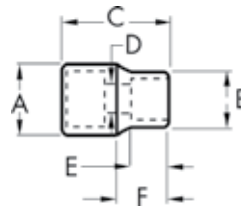

Cat. No.	UPC No.	Packaging	Drive Type	Fastener Size	Dim. A: Drive End	Dim. B: Wrench End	Dim. C: Overall Length	Dim. D: Bolt Clearance	Dim. E: Wrench Depth	Dim. F: Length to Shoulder	Product Weight
80138S	099575821387	Carded	6 Point	4 mm	0.46 in	0.27 in	1.25 in	0.08 in	0.31 in	0.76 in	0.03 lb
80139S	099575821394	Carded	6 Point	5 mm	0.46 in	0.31 in	1.25 in	0.12 in	0.31 in	0.76 in	0.03 lb
80140S	099575821400	Carded	6 Point	5.5 mm	0.46 in	0.34 in	1.25 in	0.14 in	0.47 in	0.76 in	0.03 lb
80141S	099575821417	Carded	6 Point	6 mm	0.46 in	0.36 in	1.25 in	0.16 in	0.51 in	0.76 in	0.03 lb
80142S	099575821424	Carded	6 Point	7 mm	0.46 in	0.41 in	1.25 in	0.20 in	0.51 in	0.76 in	0.03 lb
80143S	099575821431	Carded	6 Point	8 mm	0.46 in	0.46 in	1.25 in	0.24 in	0.53 in	-	0.03 lb
80144S	099575821448	Carded	6 Point	9 mm	0.50 in	0.50 in	1.25 in	0.28 in	0.53 in	-	0.04 lb
80145S	099575821455	Carded	6 Point	10 mm	0.57 in	0.57 in	1.25 in	0.31 in	0.53 in	-	0.05 lb
80146S	099575821462	Carded	6 Point	11 mm	0.55 in	0.55 in	1.25 in	0.35 in	0.57 in	-	0.06 lb
80147S	099575821479	Carded	6 Point	12 mm	0.59 in	0.59 in	1.25 in	0.39 in	0.57 in	-	0.06 lb
80148S	099575821486	Carded	6 Point	13 mm	0.63 in	0.63 in	1.25 in	0.43 in	0.57 in	-	0.07 lb
80149S	099575821493	Carded	6 Point	14 mm	0.71 in	0.71 in	1.25 in	0.47 in	0.57 in	-	0.10 lb
80150S	099575821509	Carded	6 Point	15 mm	0.79 in	0.79 in	1.25 in	0.51 in	0.57 in	-	0.12 lb

GEARWRENCH® 1/4" Drive 6 and 12 Point SAE Deep Length Sockets

- Surface Drive® Technology Reduces Fastener Rounding
- Chamfered Opening to Guide Fastener Into Socket
- Large Hard-Stamped Size Identification
- Double Line (SAE) and Knurled (Metric) Ring to Easily Identify Standard vs. Metric Sockets
- Full Polish Chrome Finish Cleans Easily and Resists Corrosion
- Meets or Exceeds ASME B107.1 and US Federal Spec. GGG-W-641 E

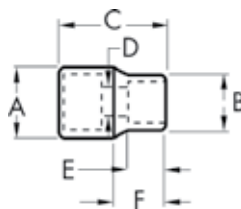

Cat. No.	UPC No.	Packaging	Drive Type	Fastener Size	Dim. A: Drive End	Dim. B: Wrench End	Dim. C: Overall Length	Dim. D: Bolt Clearance	Dim. E: Wrench Depth	Dim. F: Length to Shoulder	Product Weight
80115	099575801150	Carded	6 Point	3/16 in	0.469 in	0.307 in	1.929 in	0.177 in	0.138 in	0.866 in	0.044 lb
80116D	099575801167	Carded	6 Point	7/32 in	0.469 in	0.346 in	1.929 in	0.197 in	0.138 in	0.866 in	0.03 lb
80117	099575801174	Carded	6 Point	1/4 in	0.469 in	0.390 in	1.929 in	0.217 in	0.157 in	0.866 in	0.04 lb
80118	099575801181	Carded	6 Point	9/32 in	0.469 in	0.433 in	1.929 in	0.217 in	0.197 in	0.866 in	0.04 lb
80119	099575801198	Carded	6 Point	5/16 in	0.469 in	0.453 in	1.929 in	0.217 in	0.197 in	0.866 in	0.03 lb
80120D	099575801204	Carded	6 Point	11/32 in	0.516 in	0.516 in	1.929 in	0.217 in	0.197 in	0.866 in	0.04 lb
80121	099575801211	Carded	6 Point	3/8 in	0.575 in	0.575 in	1.929 in	0.217 in	0.201 in	0.866 in	0.08 lb
80122D	099575801228	Carded	6 Point	7/16 in	0.626 in	0.626 in	1.929 in	0.217 in	0.236 in	0.866 in	0.06 lb
80123	099575801235	Carded	6 Point	1/2 in	0.705 in	0.705 in	1.929 in	0.217 in	0.287 in	0.866 in	0.12 lb
80124	099575801242	Carded	6 Point	9/16 in	0.772 in	0.772 in	1.929 in	0.217 in	0.350 in	0.866 in	0.07 lb
80220	099575802201	Carded	12 Point	3/16 in	0.469 in	0.307 in	1.929 in	0.177 in	0.138 in	0.866 in	0.04 lb
80221	099575802218	Carded	12 Point	7/32 in	0.469 in	0.346 in	1.929 in	0.197 in	0.138 in	0.866 in	0.04 lb
80222	099575802225	Carded	12 Point	1/4 in	0.469 in	0.390 in	1.929 in	0.217 in	0.157 in	0.866 in	0.05 lb
80223D	099575802232	Carded	12 Point	9/32 in	0.469 in	0.433 in	1.929 in	0.217 in	0.197 in	0.866 in	0.05 lb
80224	099575802249	Carded	12 Point	5/16 in	0.469 in	0.453 in	1.929 in	0.217 in	0.197 in	0.866 in	0.05 lb
80225	099575802256	Carded	12 Point	11/32 in	0.516 in	0.516 in	1.929 in	0.217 in	0.197 in	0.866 in	0.05 lb
80226	099575802263	Carded	12 Point	3/8 in	0.575 in	0.575 in	1.929 in	0.217 in	0.201 in	0.866 in	0.06 lb
80227	099575802270	Carded	12 Point	7/16 in	0.626 in	0.626 in	1.929 in	0.217 in	0.236 in	0.866 in	0.09 lb
80228	099575802287	Carded	12 Point	1/2 in	0.705 in	0.705 in	1.929 in	0.217 in	0.287 in	0.866 in	0.10 lb
80229	099575802294	Carded	12 Point	9/16 in	0.772 in	0.772 in	1.929 in	0.217 in	0.350 in	0.866 in	0.13 lb

1 / 4 "

3

RATCHETS / SOCKETS / DRIVE TOOLS / SETS

GEARWRENCH® 1/4" Drive 6 and 12 Point Metric Deep Length Sockets

- Surface Drive® Technology Reduces Fastener Rounding
- Chamfered Opening to Guide Fastener Into Socket
- Large Hard-Stamped Size Identification
- Double Line (SAE) and Knurled (Metric) Ring to Easily Identify Standard vs. Metric Sockets
- Full Polish Chrome Finish Cleans Easily and Resists Corrosion
- Meets or Exceeds ASME B107.5M

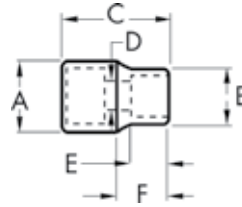

Cat. No.	UPC No.	Packaging	Drive Type	Fastener Size	Dim. A: Drive End	Dim. B: Wrench End	Dim. C: Overall Length	Dim. D: Bolt Clearance	Dim. E: Wrench Depth	Dim. F: Length to Shoulder	Product Weight
80138	099575801389	Carded	6 Point	4 mm	0.469 in	0.264 in	1.929 in	0.138 in	0.118 in	0.866 in	0.03 lb
80139	099575801396	Carded	6 Point	5 mm	0.469 in	0.315 in	1.929 in	0.177 in	0.138 in	0.866 in	0.03 lb
80140	099575801402	Carded	6 Point	5.5 mm	0.469 in	0.339 in	1.929 in	0.197 in	0.138 in	0.866 in	0.03 lb
80141	099575801419	Carded	6 Point	6 mm	0.469 in	0.362 in	1.929 in	0.217 in	0.157 in	0.866 in	0.03 lb
80142	099575801426	Carded	6 Point	7 mm	0.469 in	0.425 in	1.929 in	0.217 in	0.197 in	0.866 in	0.07 lb
80143	099575801433	Carded	6 Point	8 mm	0.469 in	0.453 in	1.929 in	0.217 in	0.197 in	0.866 in	0.07 lb
80144	099575801440	Carded	6 Point	9 mm	0.516 in	0.516 in	1.929 in	0.217 in	0.197 in	0.866 in	0.04 lb
80145	099575801457	Carded	6 Point	10 mm	0.575 in	0.575 in	1.929 in	0.217 in	0.217 in	0.866 in	0.11 lb
80146D	099575801464	Carded	6 Point	11 mm	0.626 in	0.626 in	1.929 in	0.217 in	0.256 in	0.866 in	0.10 lb
80147	099575811470	Carded	6 Point	12 mm	0.665 in	0.665 in	1.929 in	0.217 in	0.276 in	0.866 in	0.13 lb
80148	099575801488	Carded	6 Point	13 mm	0.705 in	0.705 in	1.929 in	0.217 in	0.303 in	0.866 in	0.12 lb
80149	099575801495	Carded	6 Point	14 mm	0.772 in	0.772 in	1.929 in	0.217 in	0.350 in	0.866 in	0.13 lb
80150	099575801501	Carded	6 Point	15 mm	0.819 in	0.819 in	1.929 in	0.217 in	0.350 in	0.866 in	0.15 lb
80230	099575802300	Carded	12 Point	4 mm	0.469 in	0.264 in	1.929 in	0.138 in	0.118 in	0.866 in	0.13 lb
80231	099575802317	Carded	12 Point	5 mm	0.469 in	0.315 in	1.929 in	0.177 in	0.138 in	0.866 in	0.04 lb
80232	099575802324	Carded	12 Point	5.5 mm	0.469 in	0.339 in	1.929 in	0.197 in	0.138 in	0.866 in	0.04 lb
80233	099575802331	Carded	12 Point	6 mm	0.469 in	0.362 in	1.929 in	0.217 in	0.157 in	0.866 in	0.04 lb
80234	099575802348	Carded	12 Point	7 mm	0.469 in	0.425 in	1.929 in	0.217 in	0.197 in	0.866 in	0.05 lb
80235	099575802355	Carded	12 Point	8 mm	0.469 in	0.453 in	1.929 in	0.217 in	0.197 in	0.866 in	0.06 lb
80236	099575802362	Carded	12 Point	9 mm	0.516 in	0.516 in	1.929 in	0.217 in	0.197 in	0.866 in	0.06 lb
80237	099575802379	Carded	12 Point	10 mm	0.575 in	0.575 in	1.929 in	0.217 in	0.217 in	0.866 in	0.07 lb
80238	099575802386	Carded	12 Point	11 mm	0.626 in	0.626 in	1.929 in	0.217 in	0.256 in	0.866 in	0.08 lb
80239D	099575802393	Carded	12 Point	12 mm	0.665 in	0.665 in	1.929 in	0.217 in	0.276 in	0.866 in	0.11 lb
80240	099575802409	Carded	12 Point	13 mm	0.705 in	0.705 in	1.929 in	0.217 in	0.303 in	0.866 in	0.12 lb
80241	099575802416	Carded	12 Point	14 mm	0.772 in	0.772 in	1.929 in	0.217 in	0.350 in	0.866 in	0.13 lb
80242	099575802423	Carded	12 Point	15 mm	0.819 in	0.819 in	1.929 in	0.217 in	0.350 in	0.866 in	0.15 lb

1 / 4 "

3

RATCHETS / SOCKETS / DRIVE TOOLS / SETS

GEARWRENCH® 1/4" Drive 6 Point SAE Flex Sockets

- Large Hard Stamped Identification
- Entry Angle Guides Fastener
- Full Polish Chrome Finish

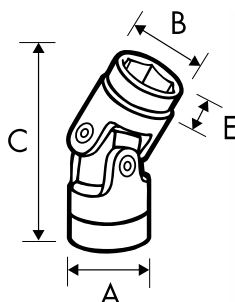

Cat. No.	UPC No.	Packaging	Fastener Size	Dim. A: Drive End	Dim. B: Wrench End	Dim. C: Overall Length	Dim. E: Wrench Depth	Product Weight
80262	099575802621	Carded	3/16 in	0.551 in	0.378 in	1.378 in	0.240 in	0.04 lb
80263D	099575802638	Carded	1/4 in	0.551 in	0.378 in	1.378 in	0.270 in	0.04 lb
80264	099575802645	Carded	5/16 in	0.551 in	0.465 in	1.378 in	0.240 in	0.04 lb
80265	099575802652	Carded	3/8 in	0.551 in	0.598 in	1.457 in	0.300 in	0.06 lb
80266	099575802669	Carded	7/16 in	0.551 in	0.677 in	1.457 in	0.320 in	0.06 lb
80267	099575802676	Carded	1/2 in	0.551 in	0.740 in	1.457 in	0.320 in	0.06 lb
80268	099575802683	Carded	9/16 in	0.551 in	0.315 in	1.457 in	0.420 in	0.06 lb

GEARWRENCH® 1/4" Drive 6 Point Metric Flex Sockets

- Large Hard Stamped Identification
- Entry Angle Guides Fastener
- Full Polish Chrome Finish

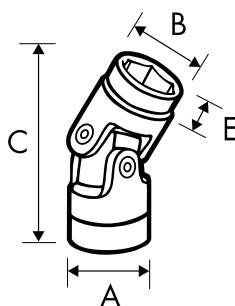

Cat. No.	UPC No.	Packaging	Fastener Size	Dim. A: Drive End	Dim. B: Wrench End	Dim. C: Overall Length	Dim. E: Wrench Depth	Product Weight
80250	099575802508	Carded	5 mm	0.551 in	0.337 in	1.378 in	0.270 in	0.04 lb
80251D	099575802515	Carded	5.5 mm	0.551 in	0.378 in	1.378 in	0.290 in	0.04 lb
80252	099575802522	Carded	6 mm	0.551 in	0.425 in	1.378 in	0.290 in	0.04 lb
80253	099575802539	Carded	7 mm	0.551 in	0.465 in	1.378 in	0.270 in	0.06 lb
80254	099575802546	Carded	8 mm	0.551 in	0.465 in	1.378 in	0.270 in	0.04 lb
80255	099575802553	Carded	9 mm	0.551 in	0.500 in	1.457 in	0.300 in	0.05 lb
80256	099575802560	Carded	10 mm	0.551 in	0.543 in	1.457 in	0.270 in	0.06 lb
80257	099575802577	Carded	11 mm	0.551 in	0.598 in	1.457 in	0.320 in	0.06 lb
80258	099575802584	Carded	12 mm	0.551 in	0.646 in	1.457 in	0.320 in	0.06 lb
80259	099575802591	Carded	13 mm	0.551 in	0.677 in	1.457 in	0.320 in	0.06 lb
80260	099575802607	Carded	14 mm	0.551 in	0.740 in	1.457 in	0.400 in	0.07 lb
80261	099575802614	Carded	15 mm	0.551 in	0.799 in	1.457 in	0.400 in	0.07 lb

1 / 4 "

3

RATCHETS / SOCKETS / DRIVE TOOLS / SETS

GEARWRENCH® 1/4" Drive SAE/Metric Hex Bit Sockets

- Heat Treated Socket Bases for Durability and Serviceability
- Professional, Full Polish Chrome
- Meets or Exceeds ASME B107.1, B107.5M

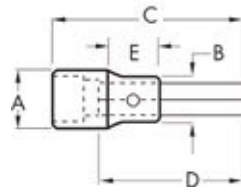

Cat. No.	UPC No.	Packaging	Fastener Size	Dim. A: Drive End	Dim. B: Nose Diameter	Dim. C: Overall Length	Dim. D: Bit Length	Exposed Bit Length	Product Weight
80151D	099575801518	Carded	1/16 in	0.508 in	0.508 in	1.530 in	0.984 in	0.655	0.05 lb
80152	099575801525	Carded	5/64 in	0.508 in	0.508 in	1.530 in	0.984 in	0.656	0.05 lb
80153	099575801532	Carded	3/32 in	0.508 in	0.508 in	1.530 in	0.984 in	0.657	0.05 lb
80154	099575801549	Carded	7/64 in	0.508 in	0.508 in	1.530 in	0.984 in	0.658	0.05 lb
80155	099575801556	Carded	1/8 in	0.508 in	0.508 in	1.530 in	0.984 in	0.659	0.05 lb
80156	099575801563	Carded	9/64 in	0.508 in	0.508 in	1.530 in	0.984 in	0.660	0.05 lb
80157	099575801570	Carded	5/32 in	0.508 in	0.508 in	1.530 in	0.984 in	0.661	0.05 lb
80158	099575801587	Carded	3/16 in	0.508 in	0.508 in	1.530 in	0.984 in	0.662	0.05 lb
80159	099575801594	Carded	7/32 in	0.508 in	0.508 in	1.530 in	0.984 in	0.663	0.05 lb
80160	099575801600	Carded	1/4 in	0.508 in	0.508 in	1.530 in	0.984 in	0.664	0.05 lb
80161	099575801617	Carded	2 mm	0.508 in	0.508 in	1.530 in	0.984 in	0.665	0.05 lb
80162	099575801624	Carded	2.5 mm	0.508 in	0.508 in	1.530 in	0.984 in	0.666	0.05 lb
80163	099575801631	Carded	3 mm	0.508 in	0.508 in	1.530 in	0.984 in	0.667	0.05 lb
80164	099575801648	Carded	4 mm	0.508 in	0.508 in	1.530 in	0.984 in	0.668	0.05 lb
80165	099575801655	Carded	5 mm	0.508 in	0.508 in	1.530 in	0.984 in	0.669	0.05 lb
80166	099575801662	Carded	6 mm	0.508 in	0.508 in	1.530 in	0.984 in	0.670	0.05 lb

GEARWRENCH® 1/4" Drive Metric Triple Square Bit Sockets

- Heat Treated Socket Bases for Durability and Serviceability
- Professional, Full Polish Chrome
- Meets or Exceeds ASME B107.5M

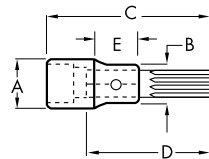

Cat. No.	UPC No.	Packaging	Fastener Size	Dim. A: Drive End	Dim. B: Nose Diameter	Dim. C: Overall Length	Dim. D: Bit Length	Exposed Bit Length	Product Weight
80167	099575801679	Carded	4 mm	0.508 in	0.508 in	1.290 in	0.748 in	0.415	0.06 lb
80168	099575801686	Carded	5 mm	0.508 in	0.508 in	1.290 in	0.748 in	0.415	0.06 lb
80169	099575801693	Carded	6 mm	0.508 in	0.508 in	1.290 in	0.748 in	0.415	0.06 lb
80170D	099575801709	Carded	8 mm	0.508 in	0.508 in	1.290 in	0.748 in	0.415	0.06 lb

GEARWRENCH® 1/4" Drive Torx® Bit Sockets

- Heat Treated Socket Bases for Durability and Serviceability
- Professional, Full Polish Chrome

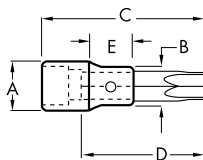

Cat. No.	UPC No.	Packaging	Fastener Size	Dim. A: Drive End	Dim. B: Nose Diameter	Dim. C: Overall Length	Dim. D: Bit Length	Exposed Bit Length	Product Weight
80171	099575801716	Carded	T8	0.508 in	0.508 in	1.530 in	0.984 in	0.688	0.05 lb
80172	099575801723	Carded	T10	0.508 in	0.508 in	1.530 in	0.984 in	0.688	0.05 lb
80173	099575801730	Carded	T15	0.508 in	0.508 in	1.530 in	0.984 in	0.688	0.05 lb
80174	099575801747	Carded	T20	0.508 in	0.508 in	1.530 in	0.984 in	0.688	0.05 lb
80175	099575801754	Carded	T25	0.508 in	0.508 in	1.530 in	0.984 in	0.688	0.05 lb
80176D	099575801761	Carded	T27	0.508 in	0.508 in	1.530 in	0.984 in	0.688	0.05 lb
80177D	099575801778	Carded	T30	0.508 in	0.508 in	1.530 in	0.984 in	0.688	0.05 lb

GEARWRENCH® 1/4" Drive Torx® Tamper Proof Bit Sockets

- Heat Treated Socket Bases for Durability and Serviceability
- Professional, Full Polish Chrome

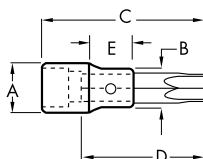

Cat. No.	UPC No.	Packaging	Fastener Size	Dim. A: Drive End	Dim. B: Nose Diameter	Dim. C: Overall Length	Dim. D: Bit Length	Exposed Bit Length	Product Weight
80178	099575801785	Carded	T7	0.508 in	0.508 in	1.530 in	0.984 in	0.688	0.05 lb
80179	099575801792	Carded	T8	0.508 in	0.508 in	1.530 in	0.984 in	0.688	0.05 lb
80180	099575801808	Carded	T10	0.508 in	0.508 in	1.530 in	0.984 in	0.688	0.05 lb
80181	099575801815	Carded	T15	0.508 in	0.508 in	1.530 in	0.984 in	0.688	0.05 lb
80182	099575801822	Carded	T20	0.508 in	0.508 in	1.530 in	0.984 in	0.688	0.05 lb
80183	099575801839	Carded	T25	0.508 in	0.508 in	1.530 in	0.984 in	0.688	0.05 lb
80184	099575801846	Carded	T27	0.508 in	0.508 in	1.530 in	0.984 in	0.688	0.05 lb
80185	099575801853	Carded	T30	0.508 in	0.508 in	1.530 in	0.984 in	0.688	0.05 lb

1 / 4 "

3

RATCHETS / SOCKETS / DRIVE TOOLS / SETS

GEARWRENCH® 1/4" Drive Torx® Long Bit Sockets

- Heat Treated Socket Bases for Durability and Serviceability
- Professional, Full Polish Chrome

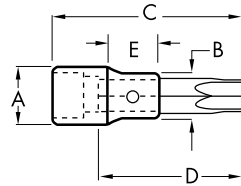

Cat. No.	UPC No.	Packaging	Fastener Size	Dim. A: Drive End	Dim. B: Nose Diameter	Dim. C: Overall Length	Dim. D: Bit Length	Exposed Bit Length	Product Weight
82510	099575825101	Carded	T8	0.508 in	0.508 in	5.980 in	5.393 in	5.105	0.125 lb
82511	099575825118	Carded	T10	0.508 in	0.508 in	5.980 in	5.393 in	5.105	0.125 lb
82512	099575825125	Carded	T15	0.508 in	0.508 in	5.980 in	5.393 in	5.105	0.15 lb
82513	099575825132	Carded	T20	0.508 in	0.508 in	5.980 in	5.393 in	5.105	0.15 lb
82514	099575825149	Carded	T25	0.508 in	0.508 in	5.980 in	5.393 in	5.105	0.15 lb
82515	099575825156	Carded	T27	0.508 in	0.508 in	5.980 in	5.393 in	5.105	0.15 lb
82516	099575825163	Carded	T30	0.508 in	0.508 in	5.980 in	5.393 in	5.105	0.18 lb

GEARWRENCH® 1/4" Drive External Torx® Sockets

- Black Oxide Finish

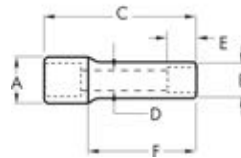

Cat. No.	UPC No.	Packaging	Fastener Size	Dim. A: Drive End	Dim. B: Nose Diameter	Dim. C: Overall Length	Dim. D: Bolt Clearance	Dim. E: Bolt Depth	Dim. F: Length to Shoulder	Product Weight
80186	099575801860	Carded	E4	0.508 in	0.251 in	0.984 in	0.078 in	0.137 in	0.044 in	0.13 lb
80187	099575801877	Carded	E5	0.508 in	0.295 in	0.984 in	0.098 in	0.196 in	0.044 in	0.13 lb
80188D	099575801884	Carded	E6	0.508 in	0.322 in	0.984 in	0.11 in	0.255 in	0.046 in	0.13 lb
80189	099575801891	Carded	E7	0.508 in	0.370 in	0.984 in	0.15 in	0.255 in	0.046 in	0.13 lb
80190	099575801907	Carded	E8	0.508 in	0.437 in	0.984 in	0.15 in	0.255 in	0.046 in	0.13 lb

GEARWRENCH® 1/4" Drive External Torx® Deep Sockets

- Heat Treated Socket Bases for Durability and Serviceability
- Professional, Full Polish Chrome

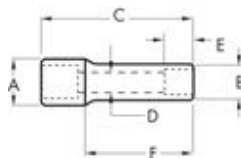

Cat. No.	UPC No.	Packaging	Fastener Size	Dim. A: Drive End	Dim. B: Nose Diameter	Dim. C: Overall Length	Product Weight
80191	099575801914	Carded	E4	0.470 in	0.224 in	1.968 in	0.20 lb
80192	099575801921	Carded	E5	0.470 in	0.275 in	1.968 in	0.20 lb
80193	099575801938	Carded	E6	0.470 in	0.314 in	1.968 in	0.20 lb
80194	099575801945	Carded	E7	0.470 in	0.354 in	1.968 in	0.20 lb
80195	099575801952	Carded	E8	0.470 in	0.393 in	1.968 in	0.20 lb
80196	099575801969	Carded	E10	0.470 in	0.470 in	1.968 in	0.20 lb
80243	099575802430	Carded	E11	0.470 in	-	1.968 in	0.25 lb

GEARWRENCH® 1/4" Drive Bit Adapter

- Heat Treated Socket Bases for Durability and Serviceability
- Professional, Full Polish Chrome
- For use with Tamper-Proof Torx® Exchangeable Bits



Cat. No.	UPC No.	Packaging	Dim. A: Drive End	Dim. B: Nose Diameter	Dim. C: Overall Length	Product Weight
80480	099575804809	Carded	0.508 in	0.251 in	0.984 in	0.04 lb

GEARWRENCH® 1/4" Drive Tamper-Proof Torx® Exchangeable Bits



Cat. No.	UPC No.	Packaging	Fastener Size	Dim. A: Drive End	Dim. B: Nose Diameter	Dim. C: Overall Length	Dim. D: Bit Length	Product Weight
80471	099575804717	Carded	T10	0.508 in	0.508 in	0.984 in	0.984 in	0.01 lb
80472	099575804724	Carded	T15	0.508 in	0.508 in	0.984 in	0.984 in	0.01 lb
80473	099575804731	Carded	T20	0.508 in	0.508 in	0.984 in	0.984 in	0.01 lb
80474	099575804748	Carded	T25	0.508 in	0.508 in	0.984 in	0.984 in	0.01 lb
80475	099575804755	Carded	T27	0.508 in	0.508 in	0.984 in	0.984 in	0.01 lb
80476	099575804762	Carded	T30	0.508 in	0.508 in	0.984 in	0.984 in	0.01 lb

1 / 4 "

3

RATCHETS / SOCKETS / DRIVE TOOLS / SETS

GEARWRENCH® 57 Pc. 3/8" Drive 6 Point SAE/Metric Standard and Deep Mechanics Tool Set

- Includes Storage Case
- Full Polish Chrome Sockets With Large Hard Stamp Size Markings
- 84 Tooth Full Polish Chrome Thin Profile Ratchets
- Knurled Full Polish Chrome Extensions
- Sockets Feature Surface Drive® Technology To Reduce Fastener Rounding
- Meets or Exceeds ASME B107.1, B107.5M, B107.10



Cat. No.	UPC No.	Packaging	Product Weight
80550	099575805509	Boxed	12.13 lb

Cat. No.	Description	Cat. No.	Description
81209F	3/8" Drive Stubby Ratchet	80375	3/8" Drive 6 Point Standard Metric Socket 7mm
81211F	3/8" Drive Full Polish Teardrop Ratchet	80376	3/8" Drive 6 Point Standard Metric Socket 8mm
81241	3/8" Drive Standard Extension 3"	80377	3/8" Drive 6 Point Standard Metric Socket 9mm
81242	3/8" Drive Standard Extension 6"	80378	3/8" Drive 6 Point Standard Metric Socket 10mm
80350	3/8" Drive 6 Point Standard SAE Socket 1/4"	80379	3/8" Drive 6 Point Standard Metric Socket 11mm
80351	3/8" Drive 6 Point Standard SAE Socket 5/16"	80380	3/8" Drive 6 Point Standard Metric Socket 12mm
80352	3/8" Drive 6 Point Standard SAE Socket 3/8"	80381	3/8" Drive 6 Point Standard Metric Socket 13mm
80353	3/8" Drive 6 Point Standard SAE Socket 7/16"	80382	3/8" Drive 6 Point Standard Metric Socket 14mm
80354	3/8" Drive 6 Point Standard SAE Socket 1/2"	80383	3/8" Drive 6 Point Standard Metric Socket 15mm
80355	3/8" Drive 6 Point Standard SAE Socket 9/16"	80384	3/8" Drive 6 Point Standard Metric Socket 16mm
80356	3/8" Drive 6 Point Standard SAE Socket 5/8"	80385	3/8" Drive 6 Point Standard Metric Socket 17mm
80357	3/8" Drive 6 Point Standard SAE Socket 11/16"	80386	3/8" Drive 6 Point Standard Metric Socket 18mm
80358	3/8" Drive 6 Point Standard SAE Socket 3/4"	80387	3/8" Drive 6 Point Standard Metric Socket 19mm
80359	3/8" Drive 6 Point Standard SAE Socket 13/16"	80388	3/8" Drive 6 Point Deep Metric Socket 6mm
80360	3/8" Drive 6 Point Standard SAE Socket 7/8"	80389	3/8" Drive 6 Point Deep Metric Socket 7mm
80361	3/8" Drive 6 Point Standard SAE Socket 15/16"	80390	3/8" Drive 6 Point Deep Metric Socket 8mm
80362	3/8" Drive 6 Point Standard SAE Socket 1"	80391	3/8" Drive 6 Point Deep Metric Socket 9mm
80363	3/8" Drive 6 Point Deep SAE Socket 1/4"	80392	3/8" Drive 6 Point Deep Metric Socket 10mm
80364	3/8" Drive 6 Point Deep SAE Socket 5/16"	80393D	3/8" Drive 6 Point Deep Metric Socket 11mm
80365	3/8" Drive 6 Point Deep SAE Socket 3/8"	80394D	3/8" Drive 6 Point Deep Metric Socket 12mm
80366	3/8" Drive 6 Point Deep SAE Socket 7/16"	80395	3/8" Drive 6 Point Deep Metric Socket 13mm
80367	3/8" Drive 6 Point Deep SAE Socket 1/2"	80396	3/8" Drive 6 Point Deep Metric Socket 14mm
80368	3/8" Drive 6 Point Deep SAE Socket 9/16"	80397	3/8" Drive 6 Point Deep Metric Socket 15mm
80369	3/8" Drive 6 Point Deep SAE Socket 5/8"	80398	3/8" Drive 6 Point Deep Metric Socket 16mm
80370D	3/8" Drive 6 Point Deep SAE Socket 11/16"	80399	3/8" Drive 6 Point Deep Metric Socket 17mm
80371	3/8" Drive 6 Point Deep SAE Socket 3/4"	80400	3/8" Drive 6 Point Deep Metric Socket 18mm
80372	3/8" Drive 6 Point Deep SAE Socket 13/16"	80401	3/8" Drive 6 Point Deep Metric Socket 19mm
80373	3/8" Drive 6 Point Deep SAE Socket 7/8"	80549	3/8" Drive Universal Joint
80374	3/8" Drive 6 Point Standard Metric Socket 6mm		

GEARWRENCH® 57 Pc. 3/8" Drive 12 Point SAE/Metric Standard and Deep Mechanics Tool Set

- Includes Storage Case
- Full Polish Chrome Sockets With Large Hard Stamp Size Markings
- 84 Tooth Full Polish Chrome Thin Profile Ratchets
- Knurled Full Polish Chrome Extensions
- Sockets Feature Surface Drive® Technology To Reduce Fastener Rounding
- Meets or Exceeds ASME B107.1, B107.5M, B107.10



Cat. No.	UPC No.	Packaging	Product Weight
80551	099575805516	Boxed	11.55 lb

Cat. No.	Description	Cat. No.	Description
81209F	3/8" Drive Stubby Ratchet	80483	3/8" Drive 12 Point Standard Metric Socket 7mm
81211F	3/8" Drive Full Polish Teardrop Ratchet	80484	3/8" Drive 12 Point Standard Metric Socket 8mm
81241	3/8" Drive Standard Extension 3"	80485	3/8" Drive 12 Point Standard Metric Socket 9mm
81242	3/8" Drive Standard Extension 6"	80486	3/8" Drive 12 Point Standard Metric Socket 10mm
80496	3/8" Drive 12 Point Standard SAE Socket 1/4"	80487	3/8" Drive 12 Point Standard Metric Socket 11mm
80497D	3/8" Drive 12 Point Standard SAE Socket 5/16"	80488	3/8" Drive 12 Point Standard Metric Socket 12mm
80498	3/8" Drive 12 Point Standard SAE Socket 3/8"	80489	3/8" Drive 12 Point Standard Metric Socket 13mm
80499	3/8" Drive 12 Point Standard SAE Socket 7/16"	80490	3/8" Drive 12 Point Standard Metric Socket 14mm
80500D	3/8" Drive 12 Point Standard SAE Socket 1/2"	80491	3/8" Drive 12 Point Standard Metric Socket 15mm
80501	3/8" Drive 12 Point Standard SAE Socket 9/16"	80492	3/8" Drive 12 Point Standard Metric Socket 16mm
80502	3/8" Drive 12 Point Standard SAE Socket 5/8"	80493	3/8" Drive 12 Point Standard Metric Socket 17mm
80503	3/8" Drive 12 Point Standard SAE Socket 11/16"	80494	3/8" Drive 12 Point Standard Metric Socket 18mm
80504	3/8" Drive 12 Point Standard SAE Socket 3/4"	80495	3/8" Drive 12 Point Standard Metric Socket 19mm
80505	3/8" Drive 12 Point Standard SAE Socket 13/16"	80520D	3/8 Drive 12 Point Deep Metric Socket 6mm
80506D	3/8" Drive 12 Point Standard SAE Socket 7/8"	80521	3/8 Drive 12 Point Deep Metric Socket 7mm
80507	3/8" Drive 12 Point Standard SAE Socket 15/16"	80522	3/8 Drive 12 Point Deep Metric Socket 8mm
80508	3/8" Drive 12 Point Standard SAE Socket 1"	80523	3/8 Drive 12 Point Deep Metric Socket 9mm
80509	3/8 Drive 12 Point Deep SAE Socket 1/4"	80524	3/8 Drive 12 Point Deep Metric Socket 10mm
80510D	3/8 Drive 12 Point Deep SAE Socket 5/16"	80525	3/8 Drive 12 Point Deep Metric Socket 11mm
80511	3/8 Drive 12 Point Deep SAE Socket 3/8"	80526	3/8 Drive 12 Point Deep Metric Socket 12mm
80512	3/8 Drive 12 Point Deep SAE Socket 7/16"	80527	3/8 Drive 12 Point Deep Metric Socket 13mm
80513	3/8 Drive 12 Point Deep SAE Socket 1/2"	80528	3/8 Drive 12 Point Deep Metric Socket 14mm
80514	3/8 Drive 12 Point Deep SAE Socket 9/16"	80529	3/8 Drive 12 Point Deep Metric Socket 15mm
80515D	3/8 Drive 12 Point Deep SAE Socket 5/8"	80530	3/8 Drive 12 Point Deep Metric Socket 16mm
80516	3/8 Drive 12 Point Deep SAE Socket 11/16"	80531	3/8 Drive 12 Point Deep Metric Socket 17mm
80517	3/8 Drive 12 Point Deep SAE Socket 3/4"	80532	3/8 Drive 12 Point Deep Metric Socket 18mm
80518	3/8 Drive 12 Point Deep SAE Socket 13/16"	80533	3/8 Drive 12 Point Deep Metric Socket 19mm
80519	3/8 Drive 12 Point Deep SAE Socket 7/8"	80549	3/8" Drive Universal Joint
80482	3/8" Drive 12 Point Standard Metric Socket 6mm		

3 / 8 "

3

RATCHETS / SOCKETS / DRIVE TOOLS / SETS

GEARWRENCH® 56 Pc. 3/8" Drive 6 Point SAE/Metric Standard and Deep Mechanics Tool Set

120XP

- 120 Position, 3° ratcheting arc ratchet with teardrop low profile head and flush mounted on/off switch for improved access
- Full Polish Chrome Sockets With Large Hard Stamp Size Markings
- Knurled Full Polish Extensions
- Sockets Feature Surface Drive® Technology To Reduce Fastener Rounding
- Meets or Exceeds ASME B107.1, B107.5M, B107.10
- Includes storage case



Cat. No.	UPC No.	Packaging	Product Weight
80550P	099575815508	Boxed	11.25 lb

Cat. No.	Description	Cat. No.	Description
81211P	3/8" Drive 120XP Full Polish Teardrop Ratchet	80375	3/8" Drive 6 Point Standard Metric Socket 7mm
81241	3/8" Drive Standard Extension 3"	80376	3/8" Drive 6 Point Standard Metric Socket 8mm
81242	3/8" Drive Standard Extension 6"	80377	3/8" Drive 6 Point Standard Metric Socket 9mm
80350	3/8" Drive 6 Point Standard SAE Socket 1/4"	80378	3/8" Drive 6 Point Standard Metric Socket 10mm
80351	3/8" Drive 6 Point Standard SAE Socket 5/16"	80379	3/8" Drive 6 Point Standard Metric Socket 11mm
80352	3/8" Drive 6 Point Standard SAE Socket 3/8"	80380	3/8" Drive 6 Point Standard Metric Socket 12mm
80353	3/8" Drive 6 Point Standard SAE Socket 7/16"	80381	3/8" Drive 6 Point Standard Metric Socket 13mm
80354	3/8" Drive 6 Point Standard SAE Socket 1/2"	80382	3/8" Drive 6 Point Standard Metric Socket 14mm
80355	3/8" Drive 6 Point Standard SAE Socket 9/16"	80383	3/8" Drive 6 Point Standard Metric Socket 15mm
80356	3/8" Drive 6 Point Standard SAE Socket 5/8"	80384	3/8" Drive 6 Point Standard Metric Socket 16mm
80357	3/8" Drive 6 Point Standard SAE Socket 11/16"	80385	3/8" Drive 6 Point Standard Metric Socket 17mm
80358	3/8" Drive 6 Point Standard SAE Socket 3/4"	80386	3/8" Drive 6 Point Standard Metric Socket 18mm
80359	3/8" Drive 6 Point Standard SAE Socket 13/16"	80387	3/8" Drive 6 Point Standard Metric Socket 19mm
80360	3/8" Drive 6 Point Standard SAE Socket 7/8"	80388	3/8" Drive 6 Point Deep Metric Socket 6mm
80361	3/8" Drive 6 Point Standard SAE Socket 15/16"	80389	3/8" Drive 6 Point Deep Metric Socket 7mm
80362	3/8" Drive 6 Point Standard SAE Socket 1"	80390	3/8" Drive 6 Point Deep Metric Socket 8mm
80363	3/8" Drive 6 Point Deep SAE Socket 1/4"	80391	3/8" Drive 6 Point Deep Metric Socket 9mm
80364	3/8" Drive 6 Point Deep SAE Socket 5/16"	80392	3/8" Drive 6 Point Deep Metric Socket 10mm
80365	3/8" Drive 6 Point Deep SAE Socket 3/8"	80393D	3/8" Drive 6 Point Deep Metric Socket 11mm
80366	3/8" Drive 6 Point Deep SAE Socket 7/16"	80394D	3/8" Drive 6 Point Deep Metric Socket 12mm
80367	3/8" Drive 6 Point Deep SAE Socket 1/2"	80395	3/8" Drive 6 Point Deep Metric Socket 13mm
80368	3/8" Drive 6 Point Deep SAE Socket 9/16"	80396	3/8" Drive 6 Point Deep Metric Socket 14mm
80369	3/8" Drive 6 Point Deep SAE Socket 5/8"	80397	3/8" Drive 6 Point Deep Metric Socket 15mm
80370D	3/8" Drive 6 Point Deep SAE Socket 11/16"	80398	3/8" Drive 6 Point Deep Metric Socket 16mm
80371	3/8" Drive 6 Point Deep SAE Socket 3/4"	80399	3/8" Drive 6 Point Deep Metric Socket 17mm
80372	3/8" Drive 6 Point Deep SAE Socket 13/16"	80400	3/8" Drive 6 Point Deep Metric Socket 18mm
80373	3/8" Drive 6 Point Deep SAE Socket 7/8"	80401	3/8" Drive 6 Point Deep Metric Socket 19mm
80374	3/8" Drive 6 Point Standard Metric Socket 6mm	80549	3/8" Drive Universal Joint

3 / 8 "

3

RATCHETS / SOCKETS / DRIVE TOOLS / SETS

GEARWRENCH® 39 Pc. 3/8" Drive 6 Point SAE Standard and Deep Mechanics Tool Set

- Includes Storage Case
- Full Polish Chrome Sockets With Large Hard Stamp Size Markings
- 84 Tooth Full Polish Chrome Thin Profile Ratchet
- Knurled Full Polish Chrome Extensions
- Bit Sockets Feature Heat Treated Full Polish Chrome Base
- Sockets Feature Surface Drive® Technology To Reduce Fastener Rounding
- Meets or Exceeds ASME B107.1, B107.10



Cat. No.	UPC No.	Packaging	Product Weight
80567	099575805677	Boxed	10.34 lb

Cat. No.	Description	Cat. No.	Description
81211F	3/8" Drive Full Polish Teardrop Ratchet	80358	3/8" Drive 6 Point Standard SAE Socket 3/4"
80414	3/8" Drive Hex Bit Socket, 1/8"	80359	3/8" Drive 6 Point Standard SAE Socket 13/16"
80416	3/8" Drive Hex Bit Socket, 5/32"	80360	3/8" Drive 6 Point Standard SAE Socket 7/8"
80417	3/8" Drive Hex Bit Socket, 3/16"	80361	3/8" Drive 6 Point Standard SAE Socket 15/16"
80418	3/8" Drive Hex Bit Socket, 7/32"	80362	3/8" Drive 6 Point Standard SAE Socket 1"
80419	3/8" Drive Hex Bit Socket, 1/4"	80363	3/8" Drive 6 Point Deep SAE Socket 1/4"
80420	3/8" Drive Hex Bit Socket, 5/16"	80364	3/8" Drive 6 Point Deep SAE Socket 5/16"
80421	3/8" Drive Hex Bit Socket, 3/8"	80365	3/8" Drive 6 Point Deep SAE Socket 3/8"
81221	3/8" Drive Full Polish Flex Handle/Breaker Bar - 12"	80366	3/8" Drive 6 Point Deep SAE Socket 7/16"
81241	3/8" Drive Standard Extension 3"	80367	3/8" Drive 6 Point Deep SAE Socket 1/2"
81242	3/8" Drive Standard Extension 6"	80368	3/8" Drive 6 Point Deep SAE Socket 9/16"
81243	3/8" Drive Standard Extension 10"	80369	3/8" Drive 6 Point Deep SAE Socket 5/8"
80350	3/8" Drive 6 Point Standard SAE Socket 1/4"	80370D	3/8" Drive 6 Point Deep SAE Socket 11/16"
80351	3/8" Drive 6 Point Standard SAE Socket 5/16"	80371	3/8" Drive 6 Point Deep SAE Socket 3/4"
80352	3/8" Drive 6 Point Standard SAE Socket 3/8"	80372	3/8" Drive 6 Point Deep SAE Socket 13/16"
80353	3/8" Drive 6 Point Standard SAE Socket 7/16"	80373	3/8" Drive 6 Point Deep SAE Socket 7/8"
80354	3/8" Drive 6 Point Standard SAE Socket 1/2"	80592	3/8 Drive 6 Point Deep SAE Socket 15/16"
80355	3/8" Drive 6 Point Standard SAE Socket 9/16"	80593	3/8 Drive 6 Point Deep SAE Socket 1"
80356	3/8" Drive 6 Point Standard SAE Socket 5/8"	80549	3/8" Drive Universal Joint
80357	3/8" Drive 6 Point Standard SAE Socket 11/16"		

3 / 8 "

3

RATCHETS / SOCKETS / DRIVE TOOLS / SETS

GEARWRENCH® 39 Pc. 3/8" Drive 12 Point SAE Standard and Deep Mechanics Tool Set

- Includes Storage Case
- Full Polish Chrome Sockets With Large Hard Stamp Size Markings
- 84 Tooth Full Polish Chrome Thin Profile Ratchet
- Knurled Full Polish Chrome Extensions
- Bit Sockets Feature Heat Treated Full Polish Chrome Base
- Sockets Feature Surface Drive® Technology To Reduce Fastener Rounding
- Meets or Exceeds ASME B107.1, B107.10



Cat. No.	UPC No.	Packaging	Product Weight
80566	099575805660	Boxed	10.31 lb

Cat. No.	Description	Cat. No.	Description
81211F	3/8" Drive Full Polish Teardrop Ratchet	80503	3/8" Drive 12 Point Standard SAE Socket 11/16"
80414	3/8" Drive Hex Bit Socket, 1/8"	80504	3/8" Drive 12 Point Standard SAE Socket 3/4"
80416	3/8" Drive Hex Bit Socket, 5/32"	80505	3/8" Drive 12 Point Standard SAE Socket 13/16"
80417	3/8" Drive Hex Bit Socket, 3/16"	80506D	3/8" Drive 12 Point Standard SAE Socket 7/8"
80418	3/8" Drive Hex Bit Socket, 7/32"	80507	3/8" Drive 12 Point Standard SAE Socket 15/16"
80419	3/8" Drive Hex Bit Socket, 1/4"	80508	3/8" Drive 12 Point Standard SAE Socket 1"
80420	3/8" Drive Hex Bit Socket, 5/16"	80509	3/8 Drive 12 Point Deep SAE Socket 1/4"
80421	3/8" Drive Hex Bit Socket, 3/8"	80510D	3/8 Drive 12 Point Deep SAE Socket 5/16"
81221	3/8" Drive Full Polish Flex Handle/Breaker Bar - 12"	80511	3/8 Drive 12 Point Deep SAE Socket 3/8"
81241	3/8" Drive Standard Extension 3"	80512	3/8 Drive 12 Point Deep SAE Socket 7/16"
81242	3/8" Drive Standard Extension 6"	80513	3/8 Drive 12 Point Deep SAE Socket 1/2"
81243	3/8" Drive Standard Extension 10"	80514	3/8 Drive 12 Point Deep SAE Socket 9/16"
80496	3/8" Drive 12 Point Standard SAE Socket 1/4"	80515D	3/8 Drive 12 Point Deep SAE Socket 5/8"
80497D	3/8" Drive 12 Point Standard SAE Socket 5/16"	80516	3/8 Drive 12 Point Deep SAE Socket 11/16"
80498	3/8" Drive 12 Point Standard SAE Socket 3/8"	80517	3/8 Drive 12 Point Deep SAE Socket 3/4"
80499	3/8" Drive 12 Point Standard SAE Socket 7/16"	80518	3/8 Drive 12 Point Deep SAE Socket 13/16"
80500D	3/8" Drive 12 Point Standard SAE Socket 1/2"	80519	3/8 Drive 12 Point Deep SAE Socket 7/8"
80501	3/8" Drive 12 Point Standard SAE Socket 9/16"	80549	3/8" Drive Universal Joint
80502	3/8" Drive 12 Point Standard SAE Socket 5/8"		

GEARWRENCH® 30 Pc. 3/8" Drive 6 Point SAE Standard and Deep Mechanics Tool Set

- Includes Storage Case
- Full Polish Chrome Sockets With Large Hard Stamp Size Markings
- 84 Tooth Full Polish Chrome Thin Profile Ratchet
- Knurled Full Polish Chrome Extensions
- Sockets Feature Surface Drive® Technology To Reduce Fastener Rounding
- Meets or Exceeds ASME B107.1, B107.10



Cat. No.	UPC No.	Packaging	Product Weight
80569	099575805691	Boxed	2.31 lb

Cat. No.	Description	Cat. No.	Description
81211F	3/8" Drive Full Polish Teardrop Ratchet	80362	3/8" Drive 6 Point Standard SAE Socket 1"
81241	3/8" Drive Standard Extension 3"	80363	3/8" Drive 6 Point Deep SAE Socket 1/4"
81242	3/8" Drive Standard Extension 6"	80364	3/8" Drive 6 Point Deep SAE Socket 5/16"
80350	3/8" Drive 6 Point Standard SAE Socket 1/4"	80365	3/8" Drive 6 Point Deep SAE Socket 3/8"
80351	3/8" Drive 6 Point Standard SAE Socket 5/16"	80366	3/8" Drive 6 Point Deep SAE Socket 7/16"
80352	3/8" Drive 6 Point Standard SAE Socket 3/8"	80367	3/8" Drive 6 Point Deep SAE Socket 1/2"
80353	3/8" Drive 6 Point Standard SAE Socket 7/16"	80368	3/8" Drive 6 Point Deep SAE Socket 9/16"
80354	3/8" Drive 6 Point Standard SAE Socket 1/2"	80369	3/8" Drive 6 Point Deep SAE Socket 5/8"
80355	3/8" Drive 6 Point Standard SAE Socket 9/16"	80370D	3/8" Drive 6 Point Deep SAE Socket 11/16"
80356	3/8" Drive 6 Point Standard SAE Socket 5/8"	80371	3/8" Drive 6 Point Deep SAE Socket 3/4"
80357	3/8" Drive 6 Point Standard SAE Socket 11/16"	80372	3/8" Drive 6 Point Deep SAE Socket 13/16"
80358	3/8" Drive 6 Point Standard SAE Socket 3/4"	80373	3/8" Drive 6 Point Deep SAE Socket 7/8"
80359	3/8" Drive 6 Point Standard SAE Socket 13/16"	80592	3/8 Drive 6 Point Deep SAE Socket 15/16"
80360	3/8" Drive 6 Point Standard SAE Socket 7/8"	80593	3/8 Drive 6 Point Deep SAE Socket 1"
80361	3/8" Drive 6 Point Standard SAE Socket 15/16"	80549	3/8" Drive Universal Joint

3 / 8 "

3 RATCHETS / SOCKETS / DRIVE TOOLS / SETS

GEARWRENCH® 30 Pc. 3/8" Drive 12 Point SAE Standard and Deep Mechanics Tool Set

- Includes Storage Case
- Full Polish Chrome Sockets With Large Hard Stamp Size Markings
- 84 Tooth Full Polish Chrome Thin Profile Ratchet
- Knurled Full Polish Chrome Extensions
- Sockets Feature Surface Drive® Technology To Reduce Fastener Rounding
- Meets or Exceeds ASME B107.1, B107.10



Cat. No.	UPC No.	Packaging	Product Weight
80568	099575805684	Boxed	2.25 lb

Cat. No.	Description	Cat. No.	Description
81211F	3/8" Drive Full Polish Teardrop Ratchet	80508	3/8" Drive 12 Point Standard SAE Socket 1"
81241	3/8" Drive Standard Extension 3"	80509	3/8 Drive 12 Point Deep SAE Socket 1/4"
81242	3/8" Drive Standard Extension 6"	80510D	3/8 Drive 12 Point Deep SAE Socket 5/16"
80496	3/8" Drive 12 Point Standard SAE Socket 1/4"	80511	3/8 Drive 12 Point Deep SAE Socket 3/8"
80497D	3/8" Drive 12 Point Standard SAE Socket 5/16"	80512	3/8 Drive 12 Point Deep SAE Socket 7/16"
80498	3/8" Drive 12 Point Standard SAE Socket 3/8"	80513	3/8 Drive 12 Point Deep SAE Socket 1/2"
80499	3/8" Drive 12 Point Standard SAE Socket 7/16"	80514	3/8 Drive 12 Point Deep SAE Socket 9/16"
80500D	3/8" Drive 12 Point Standard SAE Socket 1/2"	80515D	3/8 Drive 12 Point Deep SAE Socket 5/8"
80501	3/8" Drive 12 Point Standard SAE Socket 9/16"	80516	3/8 Drive 12 Point Deep SAE Socket 11/16"
80502	3/8" Drive 12 Point Standard SAE Socket 5/8"	80517	3/8 Drive 12 Point Deep SAE Socket 3/4"
80503	3/8" Drive 12 Point Standard SAE Socket 11/16"	80518	3/8 Drive 12 Point Deep SAE Socket 13/16"
80504	3/8" Drive 12 Point Standard SAE Socket 3/4"	80519	3/8 Drive 12 Point Deep SAE Socket 7/8"
80505	3/8" Drive 12 Point Standard SAE Socket 13/16"	80594	3/8 Drive 12 Point Deep SAE Socket 15/16"
80506D	3/8" Drive 12 Point Standard SAE Socket 7/8"	80595	3/8 Drive 12 Point Deep SAE Socket 1"
80507	3/8" Drive 12 Point Standard SAE Socket 15/16"	80549	3/8" Drive Universal Joint

GEARWRENCH® 24 Pc. 3/8" Drive 6 and 12 Point Metric Standard and Deep Mechanics Tool Set

- Includes Storage Case
- Full Polish Chrome Sockets With Large Hard Stamp Size Markings
- 84 Tooth Full Polish Chrome Thin Profile Ratchet
- Knurled Full Polish Chrome Extensions
- Sockets Feature Surface Drive® Technology To Reduce Fastener Rounding
- Meets or Exceeds ASME B107.5M, B107.10



Cat. No.	UPC No.	Packaging	Product Weight
80559	099575805592	Boxed	5.50 lb

Cat. No.	Description	Cat. No.	Description
81211F	3/8" Drive Full Polish Teardrop Ratchet	80484	3/8" Drive 12 Point Standard Metric Socket 8mm
81241	3/8" Drive Standard Extension 3"	80485	3/8" Drive 12 Point Standard Metric Socket 9mm
81242	3/8" Drive Standard Extension 6"	80486	3/8" Drive 12 Point Standard Metric Socket 10mm
80392	3/8" Drive 6 Point Deep Metric Socket 10mm	80487	3/8" Drive 12 Point Standard Metric Socket 11mm
80393D	3/8" Drive 6 Point Deep Metric Socket 11mm	80488	3/8" Drive 12 Point Standard Metric Socket 12mm
80394D	3/8" Drive 6 Point Deep Metric Socket 12mm	80489	3/8" Drive 12 Point Standard Metric Socket 13mm
80395	3/8" Drive 6 Point Deep Metric Socket 13mm	80490	3/8" Drive 12 Point Standard Metric Socket 14mm
80396	3/8" Drive 6 Point Deep Metric Socket 14mm	80491	3/8" Drive 12 Point Standard Metric Socket 15mm
80397	3/8" Drive 6 Point Deep Metric Socket 15mm	80492	3/8" Drive 12 Point Standard Metric Socket 16mm
80398	3/8" Drive 6 Point Deep Metric Socket 16mm	80493	3/8" Drive 12 Point Standard Metric Socket 17mm
80399	3/8" Drive 6 Point Deep Metric Socket 17mm	80494	3/8" Drive 12 Point Standard Metric Socket 18mm
80400	3/8" Drive 6 Point Deep Metric Socket 18mm	80495	3/8" Drive 12 Point Standard Metric Socket 19mm

3 / 8 "

3

RATCHETS / SOCKETS / DRIVE TOOLS / SETS

GEARWRENCH® 21 Pc. 3/8" Drive 6 and 12 Point SAE Standard and Deep Mechanics Tool Set

- Includes Storage Case
- Full Polish Chrome Sockets With Large Hard Stamp Size Markings
- 84 Tooth Full Polish Chrome Thin Profile Ratchet
- Knurled Full Polish Chrome Extensions
- Sockets Feature Surface Drive® Technology To Reduce Fastener Rounding
- Meets or Exceeds ASME B107.1, B107.10



Cat. No.	UPC No.	Packaging	Product Weight
80557	099575805578	Boxed	5.30 lb

Cat. No.	Description	Cat. No.	Description
81211F	3/8" Drive Full Polish Teardrop Ratchet	80373	3/8" Drive 6 Point Deep SAE Socket 7/8"
81241	3/8" Drive Standard Extension 3"	80496	3/8" Drive 12 Point Standard SAE Socket 1/4"
81242	3/8" Drive Standard Extension 6"	80497D	3/8" Drive 12 Point Standard SAE Socket 5/16"
80365	3/8" Drive 6 Point Deep SAE Socket 3/8"	80498	3/8" Drive 12 Point Standard SAE Socket 3/8"
80366	3/8" Drive 6 Point Deep SAE Socket 7/16"	80499	3/8" Drive 12 Point Standard SAE Socket 7/16"
80367	3/8" Drive 6 Point Deep SAE Socket 1/2"	80500D	3/8" Drive 12 Point Standard SAE Socket 1/2"
80368	3/8" Drive 6 Point Deep SAE Socket 9/16"	80501	3/8" Drive 12 Point Standard SAE Socket 9/16"
80369	3/8" Drive 6 Point Deep SAE Socket 5/8"	80502	3/8" Drive 12 Point Standard SAE Socket 5/8"
80370D	3/8" Drive 6 Point Deep SAE Socket 11/16"	80503	3/8" Drive 12 Point Standard SAE Socket 11/16"
80371	3/8" Drive 6 Point Deep SAE Socket 3/4"	80504	3/8" Drive 12 Point Standard SAE Socket 3/4"
80372	3/8" Drive 6 Point Deep SAE Socket 13/16"		

GEARWRENCH® 20 Pc. 3/8" Drive 6 Point Metric Mechanics Tool Set

- Includes Storage Case
- Full Polish Chrome Sockets With Large Hard Stamp Size Markings
- 84 Tooth Full Polish Chrome Thin Profile Ratchet
- Knurled Full Polish Chrome Extensions
- Sockets Feature Surface Drive® Technology To Reduce Fastener Rounding
- Meets or Exceeds ASME B107.5M, B107.10



Cat. No.	UPC No.	Packaging	Product Weight
80591	099575805912	Boxed	3.52 lb

Cat. No.	Description	Cat. No.	Description
81211F	3/8" Drive Full Polish Teardrop Ratchet	80381	3/8" Drive 6 Point Standard Metric Socket 13mm
81241	3/8" Drive Standard Extension 3"	80382	3/8" Drive 6 Point Standard Metric Socket 14mm
81242	3/8" Drive Standard Extension 6"	80383	3/8" Drive 6 Point Standard Metric Socket 15mm
80374	3/8" Drive 6 Point Standard Metric Socket 6mm	80384	3/8" Drive 6 Point Standard Metric Socket 16mm
80375	3/8" Drive 6 Point Standard Metric Socket 7mm	80385	3/8" Drive 6 Point Standard Metric Socket 17mm
80376	3/8" Drive 6 Point Standard Metric Socket 8mm	80386	3/8" Drive 6 Point Standard Metric Socket 18mm
80377	3/8" Drive 6 Point Standard Metric Socket 9mm	80387	3/8" Drive 6 Point Standard Metric Socket 19mm
80378	3/8" Drive 6 Point Standard Metric Socket 10mm	80330	3/8" Drive 6 Point Standard Metric Socket 20mm
80379	3/8" Drive 6 Point Standard Metric Socket 11mm	80331	3/8" Drive 6 Point Standard Metric Socket 21mm
80380	3/8" Drive 6 Point Standard Metric Socket 12mm	80332	3/8" Drive 6 Point Standard Metric Socket 22mm

GEARWRENCH® 20 Pc. 3/8" Drive 12 Point Metric Mechanics Tool Set

- Includes Storage Case
- Full Polish Chrome Sockets With Large Hard Stamp Size Markings
- 84 Tooth Full Polish Chrome Thin Profile Ratchet
- Knurled Full Polish Chrome Extensions
- Sockets Feature Surface Drive® Technology To Reduce Fastener Rounding
- Meets or Exceeds ASME B107.5M, B107.10



Cat. No.	UPC No.	Packaging	Product Weight
80590	099575805905	Boxed	3.49 lb

Cat. No.	Description	Cat. No.	Description
81211F	3/8" Drive Full Polish Teardrop Ratchet	80489	3/8" Drive 12 Point Standard Metric Socket 13mm
81241	3/8" Drive Standard Extension 3"	80490	3/8" Drive 12 Point Standard Metric Socket 14mm
81242	3/8" Drive Standard Extension 6"	80491	3/8" Drive 12 Point Standard Metric Socket 15mm
80482	3/8" Drive 12 Point Standard Metric Socket 6mm	80492	3/8" Drive 12 Point Standard Metric Socket 16mm
80483	3/8" Drive 12 Point Standard Metric Socket 7mm	80493	3/8" Drive 12 Point Standard Metric Socket 17mm
80484	3/8" Drive 12 Point Standard Metric Socket 8mm	80494	3/8" Drive 12 Point Standard Metric Socket 18mm
80485	3/8" Drive 12 Point Standard Metric Socket 9mm	80495	3/8" Drive 12 Point Standard Metric Socket 19mm
80486	3/8" Drive 12 Point Standard Metric Socket 10mm	80596	3/8" Drive 12 Point Standard Metric Socket 20mm
80487	3/8" Drive 12 Point Standard Metric Socket 11mm	80597	3/8" Drive 12 Point Standard Metric Socket 21mm
80488	3/8" Drive 12 Point Standard Metric Socket 12mm	80598	3/8" Drive 12 Point Standard Metric Socket 22mm

GEARWRENCH® 16 Pc. 3/8" Drive 6 Point SAE Mechanics Tool Set

- Includes Storage Case
- Full Polish Chrome Sockets With Large Hard Stamp Size Markings
- 84 Tooth Full Polish Chrome Thin Profile Ratchet
- Knurled Full Polish Chrome Extensions
- Sockets Feature Surface Drive® Technology To Reduce Fastener Rounding
- Meets or Exceeds ASME B107.1, B107.10



Cat. No.	UPC No.	Packaging	Product Weight
80589	099575805899	Boxed	3.70 lb

Cat. No.	Description	Cat. No.	Description
81211F	3/8" Drive Full Polish Teardrop Ratchet	80355	3/8" Drive 6 Point Standard SAE Socket 9/16"
81241	3/8" Drive Standard Extension 3"	80356	3/8" Drive 6 Point Standard SAE Socket 5/8"
81242	3/8" Drive Standard Extension 6"	80357	3/8" Drive 6 Point Standard SAE Socket 11/16"
80350	3/8" Drive 6 Point Standard SAE Socket 1/4"	80358	3/8" Drive 6 Point Standard SAE Socket 3/4"
80351	3/8" Drive 6 Point Standard SAE Socket 5/16"	80359	3/8" Drive 6 Point Standard SAE Socket 13/16"
80352	3/8" Drive 6 Point Standard SAE Socket 3/8"	80360	3/8" Drive 6 Point Standard SAE Socket 7/8"
80353	3/8" Drive 6 Point Standard SAE Socket 7/16"	80361	3/8" Drive 6 Point Standard SAE Socket 15/16"
80354	3/8" Drive 6 Point Standard SAE Socket 1/2"	80362	3/8" Drive 6 Point Standard SAE Socket 1"

3 / 8 "

3

RATCHETS / SOCKETS / DRIVE TOOLS / SETS

GEARWRENCH® 16 Pc. 3/8" Drive 12 Point SAE Mechanics Tool Set

- Includes Storage Case
- Full Polish Chrome Sockets With Large Hard Stamp Size Markings
- 84 Tooth Full Polish Chrome Thin Profile Ratchet
- Knurled Full Polish Chrome Extensions
- Sockets Feature Surface Drive® Technology To Reduce Fastener Rounding
- Meets or Exceeds ASME B107.1, B107.10



Cat. No.	UPC No.	Packaging	Product Weight
80584	099575805844	Boxed	3.62 lb

Cat. No.	Description	Cat. No.	Description
81211F	3/8" Drive Full Polish Teardrop Ratchet	80501	3/8" Drive 12 Point Standard SAE Socket 9/16"
81241	3/8" Drive Standard Extension 3"	80502	3/8" Drive 12 Point Standard SAE Socket 5/8"
81242	3/8" Drive Standard Extension 6"	80503	3/8" Drive 12 Point Standard SAE Socket 11/16"
80496	3/8" Drive 12 Point Standard SAE Socket 1/4"	80504	3/8" Drive 12 Point Standard SAE Socket 3/4"
80497D	3/8" Drive 12 Point Standard SAE Socket 5/16"	80505	3/8" Drive 12 Point Standard SAE Socket 13/16"
80498	3/8" Drive 12 Point Standard SAE Socket 3/8"	80506D	3/8" Drive 12 Point Standard SAE Socket 7/8"
80499	3/8" Drive 12 Point Standard SAE Socket 7/16"	80507	3/8" Drive 12 Point Standard SAE Socket 15/16"
80500D	3/8" Drive 12 Point Standard SAE Socket 1/2"	80508	3/8" Drive 12 Point Standard SAE Socket 1"

GEARWRENCH® 13 Pc. 3/8" Drive 6 Point Metric Mechanics Tool Set

- Includes Storage Case
- Full Polish Chrome Sockets With Large Hard Stamp Size Markings
- 84 Tooth Full Polish Chrome Thin Profile Ratchet
- Knurled Full Polish Chrome Extensions
- Sockets Feature Surface Drive® Technology To Reduce Fastener Rounding
- Meets or Exceeds ASME B107.5M, B107.10



Cat. No.	UPC No.	Packaging	Product Weight
80558	099575805585	Boxed	2.95 lb

Cat. No.	Description	Cat. No.	Description
81211F	3/8" Drive Full Polish Teardrop Ratchet	80380	3/8" Drive 6 Point Standard Metric Socket 12mm
81241	3/8" Drive Standard Extension 3"	80381	3/8" Drive 6 Point Standard Metric Socket 13mm
81242	3/8" Drive Standard Extension 6"	80382	3/8" Drive 6 Point Standard Metric Socket 14mm
80376	3/8" Drive 6 Point Standard Metric Socket 8mm	80383	3/8" Drive 6 Point Standard Metric Socket 15mm
80377	3/8" Drive 6 Point Standard Metric Socket 9mm	80384	3/8" Drive 6 Point Standard Metric Socket 16mm
80378	3/8" Drive 6 Point Standard Metric Socket 10mm	80385	3/8" Drive 6 Point Standard Metric Socket 17mm
80379	3/8" Drive 6 Point Standard Metric Socket 11mm		

GEARWRENCH® 12 Pc. 3/8" Drive 6 Point SAE Mechanics Tool Set

- Includes Storage Case
- Full Polish Chrome Sockets With Large Hard Stamp Size Markings
- 84 Tooth Full Polish Chrome Thin Profile Ratchet
- Knurled Full Polish Chrome Extensions
- Sockets Feature Surface Drive® Technology To Reduce Fastener Rounding
- Meets or Exceeds ASME B107.1, B107.10



Cat. No.	UPC No.	Packaging	Product Weight
80556	099575805561	Boxed	3.17 lb

Cat. No.	Description	Cat. No.	Description
81211F	3/8" Drive Full Polish Teardrop Ratchet	80355	3/8" Drive 6 Point Standard SAE Socket 9/16"
81241	3/8" Drive Standard Extension 3"	80356	3/8" Drive 6 Point Standard SAE Socket 5/8"
81242	3/8" Drive Standard Extension 6"	80357	3/8" Drive 6 Point Standard SAE Socket 11/16"
80352	3/8" Drive 6 Point Standard SAE Socket 3/8"	80358	3/8" Drive 6 Point Standard SAE Socket 3/4"
80353	3/8" Drive 6 Point Standard SAE Socket 7/16"	80359	3/8" Drive 6 Point Standard SAE Socket 13/16"
80354	3/8" Drive 6 Point Standard SAE Socket 1/2"	80360	3/8" Drive 6 Point Standard SAE Socket 7/8"

3 / 8 "

3

RATCHETS / SOCKETS / DRIVE TOOLS / SETS

GEARWRENCH® 63 Pc. 3/8" Drive 6 Point SAE/Metric Standard and Deep Socket Set

- Surface Drive® Technology Reduces Fastener Rounding
- Chamfered Opening to Guide Fastener Into Socket
- Large Hard-Stamped Size Identification
- Double Line (SAE) and Knurled (Metric) Ring to Easily Identify Standard vs. Metric Sockets
- Full Polish Chrome Finish Cleans Easily and Resists Corrosion
- Meets or Exceeds ASME B107.1, B107.5M



Cat. No.	UPC No.	Packaging	Drive Type	Product Weight
80718	099575807183	Boxed	6 Point	13.44 lb

Cat. No.	Description	Cat. No.	Description
80350	3/8" Drive 6 Point Standard SAE Socket 1/4"	80380	3/8" Drive 6 Point Standard Metric Socket 12mm
80351	3/8" Drive 6 Point Standard SAE Socket 5/16"	80381	3/8" Drive 6 Point Standard Metric Socket 13mm
80352	3/8" Drive 6 Point Standard SAE Socket 3/8"	80382	3/8" Drive 6 Point Standard Metric Socket 14mm
80353	3/8" Drive 6 Point Standard SAE Socket 7/16"	80383	3/8" Drive 6 Point Standard Metric Socket 15mm
80354	3/8" Drive 6 Point Standard SAE Socket 1/2"	80384	3/8" Drive 6 Point Standard Metric Socket 16mm
80355	3/8" Drive 6 Point Standard SAE Socket 9/16"	80385	3/8" Drive 6 Point Standard Metric Socket 17mm
80356	3/8" Drive 6 Point Standard SAE Socket 5/8"	80386	3/8" Drive 6 Point Standard Metric Socket 18mm
80357	3/8" Drive 6 Point Standard SAE Socket 11/16"	80387	3/8" Drive 6 Point Standard Metric Socket 19mm
80358	3/8" Drive 6 Point Standard SAE Socket 3/4"	80330	3/8" Drive 6 Point Standard Metric Socket 20mm
80359	3/8" Drive 6 Point Standard SAE Socket 13/16"	80331	3/8" Drive 6 Point Standard Metric Socket 21mm
80360	3/8" Drive 6 Point Standard SAE Socket 7/8"	80332	3/8" Drive 6 Point Standard Metric Socket 22mm
80361	3/8" Drive 6 Point Standard SAE Socket 15/16"	80388	3/8" Drive 6 Point Deep Metric Socket 6mm
80362	3/8" Drive 6 Point Standard SAE Socket 1"	80389	3/8" Drive 6 Point Deep Metric Socket 7mm
80363	3/8" Drive 6 Point Deep SAE Socket 1/4"	80390	3/8" Drive 6 Point Deep Metric Socket 8mm
80364	3/8" Drive 6 Point Deep SAE Socket 5/16"	80391	3/8" Drive 6 Point Deep Metric Socket 9mm
80365	3/8" Drive 6 Point Deep SAE Socket 3/8"	80392	3/8" Drive 6 Point Deep Metric Socket 10mm
80366	3/8" Drive 6 Point Deep SAE Socket 7/16"	80393D	3/8" Drive 6 Point Deep Metric Socket 11mm
80367	3/8" Drive 6 Point Deep SAE Socket 1/2"	80394D	3/8" Drive 6 Point Deep Metric Socket 12mm
80368	3/8" Drive 6 Point Deep SAE Socket 9/16"	80395	3/8" Drive 6 Point Deep Metric Socket 13mm
80369	3/8" Drive 6 Point Deep SAE Socket 5/8"	80396	3/8" Drive 6 Point Deep Metric Socket 14mm
80370D	3/8" Drive 6 Point Deep SAE Socket 11/16"	80397	3/8" Drive 6 Point Deep Metric Socket 15mm
80371	3/8" Drive 6 Point Deep SAE Socket 3/4"	80398	3/8" Drive 6 Point Deep Metric Socket 16mm
80372	3/8" Drive 6 Point Deep SAE Socket 13/16"	80399	3/8" Drive 6 Point Deep Metric Socket 17mm
80373	3/8" Drive 6 Point Deep SAE Socket 7/8"	80400	3/8" Drive 6 Point Deep Metric Socket 18mm
80592	3/8 Drive 6 Point Deep SAE Socket 15/16"	80401	3/8" Drive 6 Point Deep Metric Socket 19mm
80593	3/8 Drive 6 Point Deep SAE Socket 1"	80406	3/8 Drive 6 Point Deep Metric Socket 20mm
80374	3/8" Drive 6 Point Standard Metric Socket 6mm	80407	3/8 Drive 6 Point Deep Metric Socket 21mm
80375	3/8" Drive 6 Point Standard Metric Socket 7mm	80408	3/8 Drive 6 Point Deep Metric Socket 22mm
80376	3/8" Drive 6 Point Standard Metric Socket 8mm	80409	3/8 Drive 6 Point Deep Metric Socket 24mm
80377	3/8" Drive 6 Point Standard Metric Socket 9mm	80402	3/8" Drive Spark Plug Socket 5/8"
80378	3/8" Drive 6 Point Standard Metric Socket 10mm	80403	3/8" Drive Spark Plug Socket 13/16"
80379	3/8" Drive 6 Point Standard Metric Socket 11mm		

GEARWRENCH® 13 Pc. 3/8" Drive 6 Point SAE Standard Socket Set

- Surface Drive® Technology Reduces Fastener Rounding
- Chamfered Opening to Guide Fastener Into Socket
- Large Hard-Stamped Size Identification
- Double Line (SAE) and Knurled (Metric) Ring to Easily Identify Standard vs. Metric Sockets
- Full Polish Chrome Finish Cleans Easily and Resists Corrosion



Cat. No.	UPC No.	Packaging	Drive Type	Product Weight
80553	099575805530	Carded	6 Point	1.76 lb

Cat. No.	Description	Cat. No.	Description
80350	3/8" Drive 6 Point Standard SAE Socket 1/4"	80357	3/8" Drive 6 Point Standard SAE Socket 11/16"
80351	3/8" Drive 6 Point Standard SAE Socket 5/16"	80358	3/8" Drive 6 Point Standard SAE Socket 3/4"
80352	3/8" Drive 6 Point Standard SAE Socket 3/8"	80359	3/8" Drive 6 Point Standard SAE Socket 13/16"
80353	3/8" Drive 6 Point Standard SAE Socket 7/16"	80360	3/8" Drive 6 Point Standard SAE Socket 7/8"
80354	3/8" Drive 6 Point Standard SAE Socket 1/2"	80361	3/8" Drive 6 Point Standard SAE Socket 15/16"
80355	3/8" Drive 6 Point Standard SAE Socket 9/16"	80362	3/8" Drive 6 Point Standard SAE Socket 1"
80356	3/8" Drive 6 Point Standard SAE Socket 5/8"		

GEARWRENCH® 13 Pc. 3/8" Drive 12 Point SAE Standard Socket Set

- Surface Drive® Technology Reduces Fastener Rounding
- Chamfered Opening to Guide Fastener Into Socket
- Large Hard-Stamped Size Identification
- Double Line (SAE) and Knurled (Metric) Ring to Easily Identify Standard vs. Metric Sockets
- Full Polish Chrome Finish Cleans Easily and Resists Corrosion



Cat. No.	UPC No.	Packaging	Drive Type	Product Weight
80561	099575805615	Carded	12 Point	1.76 lb

Cat. No.	Description	Cat. No.	Description
80496	3/8" Drive 12 Point Standard SAE Socket 1/4"	80503	3/8" Drive 12 Point Standard SAE Socket 11/16"
80497D	3/8" Drive 12 Point Standard SAE Socket 5/16"	80504	3/8" Drive 12 Point Standard SAE Socket 3/4"
80498	3/8" Drive 12 Point Standard SAE Socket 3/8"	80505	3/8" Drive 12 Point Standard SAE Socket 13/16"
80499	3/8" Drive 12 Point Standard SAE Socket 7/16"	80506D	3/8" Drive 12 Point Standard SAE Socket 7/8"
80500D	3/8" Drive 12 Point Standard SAE Socket 1/2"	80507	3/8" Drive 12 Point Standard SAE Socket 15/16"
80501	3/8" Drive 12 Point Standard SAE Socket 9/16"	80508	3/8" Drive 12 Point Standard SAE Socket 1"
80502	3/8" Drive 12 Point Standard SAE Socket 5/8"		

GEARWRENCH® 11 Pc. 3/8" Drive 6 Point SAE Mid Length Socket Set

- Mid Length Design for Access to Difficult Fasteners
- Surface Drive® Technology Reduces Fastener Rounding
- Chamfered Opening to Guide Fastener Into Socket
- Large Hard-Stamped Size Identification
- Double Line (SAE) and Knurled (Metric) Ring to Easily Identify Standard vs. Metric Sockets
- Full Polish Chrome Finish Cleans Easily and Resists Corrosion
- Meets or Exceeds ASME B107.1



Cat. No.	UPC No.	Packaging	Drive Type	Product Weight
80555S	099575835551	Carded	6 Point	1.82 lb

Cat. No.	Description	Cat. No.	Description
80363S	3/8" Drive 6 Point Mid Length SAE Socket 1/4"	80369S	3/8" Drive 6 Point Mid Length SAE Socket 5/8"
80364S	3/8" Drive 6 Point Mid Length SAE Socket 5/16"	80370S	3/8" Drive 6 Point Mid Length SAE Socket 11/16"
80365S	3/8" Drive 6 Point Mid Length SAE Socket 3/8"	80371S	3/8" Drive 6 Point Mid Length SAE Socket 3/4"
80366S	3/8" Drive 6 Point Mid Length SAE Socket 7/16"	80372S	3/8" Drive 6 Point Mid Length SAE Socket 13/16"
80367S	3/8" Drive 6 Point Mid Length SAE Socket 1/2"	80373S	3/8" Drive 6 Point Mid Length SAE Socket 7/8"
80368S	3/8" Drive 6 Point Mid Length SAE Socket 9/16"		

GEARWRENCH® 11 Pc. 3/8" Drive 6 Point SAE Deep Socket Set

- Surface Drive® Technology Reduces Fastener Rounding
- Chamfered Opening to Guide Fastener Into Socket
- Large Hard-Stamped Size Identification
- Double Line (SAE) and Knurled (Metric) Ring to Easily Identify Standard vs. Metric Sockets
- Full Polish Chrome Finish Cleans Easily and Resists Corrosion
- Meets or Exceeds ASME B107.1



Cat. No.	UPC No.	Packaging	Drive Type	Product Weight
80555	099575805554	Carded	6 Point	3.04 lb

Cat. No.	Description	Cat. No.	Description
80363	3/8" Drive 6 Point Deep SAE Socket 1/4"	80369	3/8" Drive 6 Point Deep SAE Socket 5/8"
80364	3/8" Drive 6 Point Deep SAE Socket 5/16"	80370D	3/8" Drive 6 Point Deep SAE Socket 11/16"
80365	3/8" Drive 6 Point Deep SAE Socket 3/8"	80371	3/8" Drive 6 Point Deep SAE Socket 3/4"
80366	3/8" Drive 6 Point Deep SAE Socket 7/16"	80372	3/8" Drive 6 Point Deep SAE Socket 13/16"
80367	3/8" Drive 6 Point Deep SAE Socket 1/2"	80373	3/8" Drive 6 Point Deep SAE Socket 7/8"
80368	3/8" Drive 6 Point Deep SAE Socket 9/16"		

3 / 8 "

3

RATCHETS / SOCKETS / DRIVE TOOLS / SETS

GEARWRENCH® 11 Pc. 3/8" Drive 12 Point SAE Deep Socket Set

- Surface Drive® Technology Reduces Fastener Rounding
- Chamfered Opening to Guide Fastener Into Socket
- Large Hard-Stamped Size Identification
- Double Line (SAE) and Knurled (Metric) Ring to Easily Identify Standard vs. Metric Sockets
- Full Polish Chrome Finish Cleans Easily and Resists Corrosion
- Meets or Exceeds ASME B107.1



Cat. No.	UPC No.	Packaging	Drive Type	Product Weight
80563	099575805639	Carded	12 Point	3.04 lb

Cat. No.	Description	Cat. No.	Description
80509	3/8 Drive 12 Point Deep SAE Socket 1/4"	80515D	3/8 Drive 12 Point Deep SAE Socket 5/8"
80510D	3/8 Drive 12 Point Deep SAE Socket 5/16"	80516	3/8 Drive 12 Point Deep SAE Socket 11/16"
80511	3/8 Drive 12 Point Deep SAE Socket 3/8"	80517	3/8 Drive 12 Point Deep SAE Socket 3/4"
80512	3/8 Drive 12 Point Deep SAE Socket 7/16"	80518	3/8 Drive 12 Point Deep SAE Socket 13/16"
80513	3/8 Drive 12 Point Deep SAE Socket 1/2"	80519	3/8 Drive 12 Point Deep SAE Socket 7/8"
80514	3/8 Drive 12 Point Deep SAE Socket 9/16"		

GEARWRENCH® 14 Pc. 3/8" Drive 6 Point Metric Standard Socket Set

- Surface Drive® Technology Reduces Fastener Rounding
- Chamfered Opening to Guide Fastener Into Socket
- Large Hard-Stamped Size Identification
- Double Line (SAE) and Knurled (Metric) Ring to Easily Identify Standard vs. Metric Sockets
- Full Polish Chrome Finish Cleans Easily and Resists Corrosion
- Meets or Exceeds ASME B107.5M



Cat. No.	UPC No.	Packaging	Drive Type	Product Weight
80552	099575805523	Carded	6 Point	1.35 lb

Cat. No.	Description	Cat. No.	Description
80374	3/8" Drive 6 Point Standard Metric Socket 6mm	80381	3/8" Drive 6 Point Standard Metric Socket 13mm
80375	3/8" Drive 6 Point Standard Metric Socket 7mm	80382	3/8" Drive 6 Point Standard Metric Socket 14mm
80376	3/8" Drive 6 Point Standard Metric Socket 8mm	80383	3/8" Drive 6 Point Standard Metric Socket 15mm
80377	3/8" Drive 6 Point Standard Metric Socket 9mm	80384	3/8" Drive 6 Point Standard Metric Socket 16mm
80378	3/8" Drive 6 Point Standard Metric Socket 10mm	80385	3/8" Drive 6 Point Standard Metric Socket 17mm
80379	3/8" Drive 6 Point Standard Metric Socket 11mm	80386	3/8" Drive 6 Point Standard Metric Socket 18mm
80380	3/8" Drive 6 Point Standard Metric Socket 12mm	80387	3/8" Drive 6 Point Standard Metric Socket 19mm

3 / 8 "

3

RATCHETS / SOCKETS / DRIVE TOOLS / SETS

GEARWRENCH® 14 Pc. 3/8" Drive 12 Point Metric Standard Socket Set

- Surface Drive® Technology Reduces Fastener Rounding
- Chamfered Opening to Guide Fastener Into Socket
- Large Hard-Stamped Size Identification
- Double Line (SAE) and Knurled (Metric) Ring to Easily Identify Standard vs. Metric Sockets
- Full Polish Chrome Finish Cleans Easily and Resists Corrosion
- Meets or Exceeds B107.5M



Cat. No.	UPC No.	Packaging	Drive Type	Product Weight
80560	099575805608	Carded	12 Point	1.34 lb

Cat. No.	Description	Cat. No.	Description
80482	3/8" Drive 12 Point Standard Metric Socket 6mm	80489	3/8" Drive 12 Point Standard Metric Socket 13mm
80483	3/8" Drive 12 Point Standard Metric Socket 7mm	80490	3/8" Drive 12 Point Standard Metric Socket 14mm
80484	3/8" Drive 12 Point Standard Metric Socket 8mm	80491	3/8" Drive 12 Point Standard Metric Socket 15mm
80485	3/8" Drive 12 Point Standard Metric Socket 9mm	80492	3/8" Drive 12 Point Standard Metric Socket 16mm
80486	3/8" Drive 12 Point Standard Metric Socket 10mm	80493	3/8" Drive 12 Point Standard Metric Socket 17mm
80487	3/8" Drive 12 Point Standard Metric Socket 11mm	80494	3/8" Drive 12 Point Standard Metric Socket 18mm
80488	3/8" Drive 12 Point Standard Metric Socket 12mm	80495	3/8" Drive 12 Point Standard Metric Socket 19mm

GEARWRENCH® 14 Pc. 3/8" Drive 6 Point Metric Mid Length Socket Set

- Mid Length Design for Access to Difficult Fasteners
- Surface Drive® Technology Reduces Fastener Rounding
- Chamfered Opening to Guide Fastener Into Socket
- Large Hard-Stamped Size Identification
- Double Line (SAE) and Knurled (Metric) Ring to Easily Identify Standard vs. Metric Sockets
- Full Polish Chrome Finish Cleans Easily and Resists Corrosion
- Meets or Exceeds ASME B107.5M



Cat. No.	UPC No.	Packaging	Drive Type	Product Weight
80554S	099575835544	Carded	6 Point	1.98 lb

Cat. No.	Description	Cat. No.	Description
80388S	3/8" Drive 6 Point Mid Length Metric Socket 6mm	80395S	3/8" Drive 6 Point Mid Length Metric Socket 13mm
80389S	3/8" Drive 6 Point Mid Length Metric Socket 7mm	80396S	3/8" Drive 6 Point Mid Length Metric Socket 14mm
80390S	3/8" Drive 6 Point Mid Length Metric Socket 8mm	80397S	3/8" Drive 6 Point Mid Length Metric Socket 15mm
80391S	3/8" Drive 6 Point Mid Length Metric Socket 9mm	80398S	3/8" Drive 6 Point Mid Length Metric Socket 16mm
80392S	3/8" Drive 6 Point Mid Length Metric Socket 10mm	80399S	3/8" Drive 6 Point Mid Length Metric Socket 17mm
80393S	3/8" Drive 6 Point Mid Length Metric Socket 11mm	80400S	3/8" Drive 6 Point Mid Length Metric Socket 18mm
80394S	3/8" Drive 6 Point Mid Length Metric Socket 12mm	80401S	3/8" Drive 6 Point Mid Length Metric Socket 19mm

GEARWRENCH® 14 Pc. 3/8" Drive 6 Point Metric Deep Socket Set

- Surface Drive® Technology Reduces Fastener Rounding
- Chamfered Opening to Guide Fastener Into Socket
- Large Hard-Stamped Size Identification
- Double Line (SAE) and Knurled (Metric) Ring to Easily Identify Standard vs. Metric Sockets
- Full Polish Chrome Finish Cleans Easily and Resists Corrosion
- Meets or Exceeds ASME B107.5M



Cat. No.	UPC No.	Packaging	Drive Type	Product Weight
80554	099575805547	Carded	6 Point	2.87 lb

Cat. No.	Description	Cat. No.	Description
80388	3/8" Drive 6 Point Deep Metric Socket 6mm	80395	3/8" Drive 6 Point Deep Metric Socket 13mm
80389	3/8" Drive 6 Point Deep Metric Socket 7mm	80396	3/8" Drive 6 Point Deep Metric Socket 14mm
80390	3/8" Drive 6 Point Deep Metric Socket 8mm	80397	3/8" Drive 6 Point Deep Metric Socket 15mm
80391	3/8" Drive 6 Point Deep Metric Socket 9mm	80398	3/8" Drive 6 Point Deep Metric Socket 16mm
80392	3/8" Drive 6 Point Deep Metric Socket 10mm	80399	3/8" Drive 6 Point Deep Metric Socket 17mm
80393D	3/8" Drive 6 Point Deep Metric Socket 11mm	80400	3/8" Drive 6 Point Deep Metric Socket 18mm
80394D	3/8" Drive 6 Point Deep Metric Socket 12mm	80401	3/8" Drive 6 Point Deep Metric Socket 19mm

GEARWRENCH® 14 Pc. 3/8" Drive 12 Point Metric Deep Socket Set

- Surface Drive® Technology Reduces Fastener Rounding
- Chamfered Opening to Guide Fastener Into Socket
- Large Hard-Stamped Size Identification
- Double Line (SAE) and Knurled (Metric) Ring to Easily Identify Standard vs. Metric Sockets
- Full Polish Chrome Finish Cleans Easily and Resists Corrosion
- Meets or Exceeds ASME B107.5M



Cat. No.	UPC No.	Packaging	Drive Type	Product Weight
80562	099575805622	Carded	12 Point	2.89 lb

Cat. No.	Description	Cat. No.	Description
80520D	3/8 Drive 12 Point Deep Metric Socket 6mm	80527	3/8 Drive 12 Point Deep Metric Socket 13mm
80521	3/8 Drive 12 Point Deep Metric Socket 7mm	80528	3/8 Drive 12 Point Deep Metric Socket 14mm
80522	3/8 Drive 12 Point Deep Metric Socket 8mm	80529	3/8 Drive 12 Point Deep Metric Socket 15mm
80523	3/8 Drive 12 Point Deep Metric Socket 9mm	80530	3/8 Drive 12 Point Deep Metric Socket 16mm
80524	3/8 Drive 12 Point Deep Metric Socket 10mm	80531	3/8 Drive 12 Point Deep Metric Socket 17mm
80525	3/8 Drive 12 Point Deep Metric Socket 11mm	80532	3/8 Drive 12 Point Deep Metric Socket 18mm
80526	3/8 Drive 12 Point Deep Metric Socket 12mm	80533	3/8 Drive 12 Point Deep Metric Socket 19mm

3 / 8 "

3

RATCHETS / SOCKETS / DRIVE TOOLS / SETS

GEARWRENCH® 7 Pc. 3/8" Drive 6 Point SAE Flex Socket Set

- Large Hard-Stamped Identification
- Entry Angle Guides Fastener



SAE

6

Cat. No.	UPC No.	Packaging	Product Weight
80564	099575805646	Boxed	2.20 lb

Cat. No.	Description	Cat. No.	Description
80343	3/8" Drive 6 Point Flex Socket 3/8"	80347	3/8" Drive 6 Point Flex Socket 5/8"
80344	3/8" Drive 6 Point Flex Socket 7/16"	80348	3/8" Drive 6 Point Flex Socket 11/16"
80345	3/8" Drive 6 Point Flex Socket 1/2"	80349	3/8" Drive 6 Point Flex Socket 3/4"
80346	3/8" Drive 6 Point Flex Socket 9/16"		

GEARWRENCH® 10 Pc. 3/8" Drive 6 Point Metric Flex Socket Set

- Large Hard-Stamped Identification
- Entry Angle Guides Fastener



mm

6

Cat. No.	UPC No.	Packaging	Product Weight
80565	099575805653	Boxed	2.20 lb

Cat. No.	Description	Cat. No.	Description
80333	3/8" Drive 6 Point Flex Socket 10mm	80338	3/8" Drive 6 Point Flex Socket 15mm
80334	3/8" Drive 6 Point Flex Socket 11mm	80339	3/8" Drive 6 Point Flex Socket 16mm
80335	3/8" Drive 6 Point Flex Socket 12mm	80340	3/8" Drive 6 Point Flex Socket 17mm
80336	3/8" Drive 6 Point Flex Socket 13mm	80341	3/8" Drive 6 Point Flex Socket 18mm
80337	3/8" Drive 6 Point Flex Socket 14mm	80342	3/8" Drive 6 Point Flex Socket 19mm

GEARWRENCH® 11 Pc. 3/8" Drive SAE Ratcheting Crowfoot Wrench Set

- Quickly Ratchet Nuts and Bolts Without Removing the Wrench From the Fastener
- Exceeds ASME Requirements for Torque Performance
- Size Laser Etched on Both Sides of Head for Easy Identification
- Bright Chrome Finish



Cat. No.	UPC No.	Packaging	Product Weight
89118	099575891182	Blow Mold Case	2.20 lb

Cat. No.	Description	Cat. No.	Description
89120	3/8" Drive Ratcheting Crowfoot Wrench 3/8"	89126	3/8" Drive Ratcheting Crowfoot Wrench 3/4"
89121	3/8" Drive Ratcheting Crowfoot Wrench 7/16"	89127	3/8" Drive Ratcheting Crowfoot Wrench 13/16"
89122	3/8" Drive Ratcheting Crowfoot Wrench 1/2"	89128	3/8" Drive Ratcheting Crowfoot Wrench 7/8"
89123	3/8" Drive Ratcheting Crowfoot Wrench 9/16"	89129	3/8" Drive Ratcheting Crowfoot Wrench 15/16"
89124	3/8" Drive Ratcheting Crowfoot Wrench 5/8"	89130	3/8" Drive Ratcheting Crowfoot Wrench 1"
89125	3/8" Drive Ratcheting Crowfoot Wrench 11/16"		

GEARWRENCH® 10 Pc. 3/8" Drive Metric Ratcheting Crowfoot Wrench Set

- Quickly Ratchet Nuts and Bolts Without Removing the Wrench From the Fastener
- Exceeds ASME Requirements for Torque Performance
- Size Laser Etched on Both Sides of Head for Easy Identification
- Bright Chrome Finish



Cat. No.	UPC No.	Packaging	Product Weight
89119	099575891199	Blow Mold Case	1.30 lb

Cat. No.	Description	Cat. No.	Description
89140	3/8" Drive Ratcheting Crowfoot Wrench 10mm	89145	3/8" Drive Ratcheting Crowfoot Wrench 15mm
89141	3/8" Drive Ratcheting Crowfoot Wrench 11mm	89146	3/8" Drive Ratcheting Crowfoot Wrench 16mm
89142	3/8" Drive Ratcheting Crowfoot Wrench 12mm	89147	3/8" Drive Ratcheting Crowfoot Wrench 17mm
89143	3/8" Drive Ratcheting Crowfoot Wrench 13mm	89148	3/8" Drive Ratcheting Crowfoot Wrench 18mm
89144	3/8" Drive Ratcheting Crowfoot Wrench 14mm	89149	3/8" Drive Ratcheting Crowfoot Wrench 19mm

3 / 8 "

3

RATCHETS / SOCKETS / DRIVE TOOLS / SETS

GEARWRENCH® 11 Pc. 3/8" Drive SAE Crowfoot Wrench Set

- Premium Alloy CV Steel
- Includes Blow Mold Tray



SAE

Cat. No.	UPC No.	Packaging	Product Weight
81908	099575819087	Blow Mold Case	1.98 lb

Cat. No.	Description	Cat. No.	Description
81603	3/8" Drive Crowfoot Wrench 3/8"	81609	3/8" Drive Crowfoot Wrench 3/4"
81604	3/8" Drive Crowfoot Wrench 7/16"	81610	3/8" Drive Crowfoot Wrench 13/16"
81605	3/8" Drive Crowfoot Wrench 1/2"	81611D	3/8" Drive Crowfoot Wrench 7/8"
81606	3/8" Drive Crowfoot Wrench 9/16"	81612D	3/8" Drive Crowfoot Wrench 15/16"
81607	3/8" Drive Crowfoot Wrench 5/8"	81613	3/8" Drive Crowfoot Wrench 1"
81608	3/8" Drive Crowfoot Wrench 11/16"		

GEARWRENCH® 10 Pc. 3/8" Drive Metric Crowfoot Wrench Set

- Premium Alloy CV Steel
- Includes Blow Mold Tray



mm

Cat. No.	UPC No.	Packaging	Product Weight
81909	099575819094	Blow Mold Case	1.43 lb

Cat. No.	Description	Cat. No.	Description
81614	3/8" Drive Crowfoot Wrench 10mm	81619	3/8" Drive Crowfoot Wrench 15mm
81615	3/8" Drive Crowfoot Wrench 11mm	81620	3/8" Drive Crowfoot Wrench 16mm
81616	3/8" Drive Crowfoot Wrench 12mm	81621	3/8" Drive Crowfoot Wrench 17mm
81617	3/8" Drive Crowfoot Wrench 13mm	81622	3/8" Drive Crowfoot Wrench 18mm
81618	3/8" Drive Crowfoot Wrench 14mm	81623	3/8" Drive Crowfoot Wrench 19mm

GEARWRENCH® 12 Pc. 3/8" Drive SAE Hex Bit Socket Set

- Heat Treated Socket Bases for Durability and Serviceability
- Professional, Full Polish Chrome
- Includes Socket Rail



Cat. No.	UPC No.	Packaging	Product Weight
80581	099575805813	Carded	1.44 lb

Cat. No.	Description	Cat. No.	Description	Cat. No.	Description
80410	3/8" Drive Hex Bit Socket, 1/16"	80414	3/8" Drive Hex Bit Socket, 1/8"	80418	3/8" Drive Hex Bit Socket, 7/32"
80411	3/8" Drive Hex Bit Socket, 5/64"	80415D	3/8" Drive Hex Bit Socket, 9/64"	80419	3/8" Drive Hex Bit Socket, 1/4"
80412D	3/8" Drive Hex Bit Socket, 3/32"	80416	3/8" Drive Hex Bit Socket, 5/32"	80420	3/8" Drive Hex Bit Socket, 5/16"
80413	3/8" Drive Hex Bit Socket, 7/64"	80417	3/8" Drive Hex Bit Socket, 3/16"	80421	3/8" Drive Hex Bit Socket, 3/8"

GEARWRENCH® 12 Pc. 3/8" Drive Metric Hex Bit Socket Set

- Heat Treated Socket Bases for Durability and Serviceability
- Professional, Full Polish Chrome
- Includes Socket Rail



Cat. No.	UPC No.	Packaging	Product Weight
80580	099575805806	Carded	1.68 lb

Cat. No.	Description	Cat. No.	Description	Cat. No.	Description
80422	3/8" Drive Hex Bit Socket, 2mm	80426	3/8" Drive Hex Bit Socket, 5mm	80430	3/8" Drive Hex Bit Socket, 9mm
80423	3/8" Drive Hex Bit Socket, 2.5mm	80427	3/8" Drive Hex Bit Socket, 6mm	80431	3/8" Drive Hex Bit Socket, 10mm
80424	3/8" Drive Hex Bit Socket, 3mm	80428D	3/8" Drive Hex Bit Socket, 7mm	80432	3/8" Drive Hex Bit Socket, 11mm
80425	3/8" Drive Hex Bit Socket, 4mm	80429	3/8" Drive Hex Bit Socket, 8mm	80433	3/8" Drive Hex Bit Socket, 12mm

GEARWRENCH® 7 Pc. 3/8" Drive SAE Hex Ball End Bit Socket Set

- Heat Treated Socket Bases for Durability and Serviceability
- Professional, Full Polish Chrome
- Includes Socket Rail



Cat. No.	UPC No.	Packaging	Product Weight
80586	099575805868	Carded	1.00 lb

Cat. No.	Description	Cat. No.	Description	Cat. No.	Description
80539	3/8" Drive Ball Hex Bit Socket, 1/8"	80542	3/8" Drive Ball Hex Bit Socket, 7/32"	80545	3/8" Drive Ball Hex Bit Socket, 3/8"
80540	3/8" Drive Ball Hex Bit Socket, 5/32"	80543	3/8" Drive Ball Hex Bit Socket, 1/4"		
80541	3/8" Drive Ball Hex Bit Socket, 3/16"	80544	3/8" Drive Ball Hex Bit Socket, 5/16"		

3 / 8 "

3

RATCHETS / SOCKETS / DRIVE TOOLS / SETS

GEARWRENCH® 7 Pc. 3/8" Drive Metric Hex Ball End Bit Socket Set

- Heat Treated Socket Bases for Durability and Serviceability
- Professional, Full Polish Chrome
- Includes Socket Rail



Cat. No.	UPC No.	Packaging	Product Weight
80587	099575805875	Carded	1.05 lb

Cat. No.	Description	Cat. No.	Description	Cat. No.	Description
82500	3/8" Drive Ball Hex Bit Socket, 4mm	82503	3/8" Drive Ball Hex Bit Socket, 7mm	82506	3/8" Drive Ball Hex Bit Socket, 10mm
82501	3/8" Drive Ball Hex Bit Socket, 5mm	82504	3/8" Drive Ball Hex Bit Socket, 8mm		
82502	3/8" Drive Ball Hex Bit Socket, 6mm	82505	3/8" Drive Ball Hex Bit Socket, 9mm		

GEARWRENCH® 8 Pc. 3/8" Drive Metric Hex Long Ball End Bit Socket Set

- Heat Treated Socket Bases for Durability and Serviceability
- Professional, Full Polish Chrome
- Includes Socket Rail
- All Bit Sockets 6" Long



Cat. No.	UPC No.	Packaging	Product Weight
80573	099575805738	Carded	1.59 lb

Cat. No.	Description	Cat. No.	Description	Cat. No.	Description
80441	3/8" Drive Long Ball Hex Bit Socket, 3mm	80444	3/8" Drive Long Ball Hex Bit Socket, 6mm	80447	3/8" Drive Long Ball Hex Bit Socket, 9mm
80442	3/8" Drive Long Ball Hex Bit Socket, 4mm	80445	3/8" Drive Long Ball Hex Bit Socket, 7mm	80448	3/8" Drive Long Ball Hex Bit Socket, 10mm
80443	3/8" Drive Long Ball Hex Bit Socket, 5mm	80446	3/8" Drive Long Ball Hex Bit Socket, 8mm		

GEARWRENCH® 7 Pc. 3/8" Drive SAE Hex Long Ball End Bit Socket Set

- Heat Treated Socket Bases for Durability and Serviceability
- Professional, Full Polish Chrome
- Includes Socket Rail
- All Bit Sockets 6" Long



Cat. No.	UPC No.	Packaging	Product Weight
80574	099575805745	Carded	1.13 lb

Cat. No.	Description	Cat. No.	Description	Cat. No.	Description
80434	3/8" Drive Long Ball Hex Bit Socket, 1/8"	80437	3/8" Drive Long Ball Hex Bit Socket, 7/32"	80440	3/8" Drive Long Ball Hex Bit Socket, 3/8"
80435	3/8" Drive Long Ball Hex Bit Socket, 5/32"	80438	3/8" Drive Long Ball Hex Bit Socket, 1/4"		
80436D	3/8" Drive Long Ball Hex Bit Socket, 3/16"	80439	3/8" Drive Long Ball Hex Bit Socket, 5/16"		

3 / 8 "

3

RATCHETS / SOCKETS / DRIVE TOOLS / SETS

GEARWRENCH® 7 Pc. 3/8" Drive Slotted/Phillips/Pozidriv® Bit Socket Set

- Heat Treated Socket Bases for Durability and Serviceability
- Professional, Full Polish Chrome
- Includes Socket Rail



Cat. No.	UPC No.	Packaging	Product Weight
80577	099575805776	Carded	0.70 lb

Cat. No.	Description	Cat. No.	Description
80467	3/8" Drive Screwdriver Bit Socket, #1 Phillips	80465	3/8" Drive Screwdriver Bit Socket, 5mm Slotted
80468	3/8" Drive Screwdriver Bit Socket, #2 Phillips	80466	3/8" Drive Screwdriver Bit Socket, 6mm Slotted
80469	3/8" Drive Screwdriver Bit Socket, #3 Phillips	80470	3/8" Drive Screwdriver Bit Socket, #2 Pozidriv®
80464	3/8" Drive Screwdriver Bit Socket, 4mm Slotted		

GEARWRENCH® 3 Pc. 3/8" Drive Torx® Brake Bit Socket Set

- Heat Treated Socket Bases for Durability and Serviceability
- Professional, Full Polish Chrome
- Includes Socket Rail



Cat. No.	UPC No.	Packaging	Product Weight
80571	099575805714	Carded	0.34 lb

Cat. No.	Description	Cat. No.	Description
80451	3/8" Drive TORX® Press-Fit Bit Socket, T-40	80454	3/8" Drive TORX® Press-Fit Bit Socket, T-50
80452	3/8" Drive TORX® Press-Fit Bit Socket, T-45		

GEARWRENCH® 3 Pc. 3/8" Drive SAE/Metric Hex Bit Socket Set

- Heat Treated Socket Bases for Durability and Serviceability
- Professional, Full Polish Chrome



Cat. No.	UPC No.	Packaging	Product Weight
80570	099575805707	Carded	0.30 lb

Cat. No.	Description	Cat. No.	Description
80419	3/8" Drive Hex Bit Socket, 1/4"	80429	3/8" Drive Hex Bit Socket, 8mm
80421	3/8" Drive Hex Bit Socket, 3/8"		

3 / 8 " RATCHETS / SOCKETS / DRIVE TOOLS / SETS

GEARWRENCH® 3 Pc. 3/8" Drive Spark Plug Ratchet Set

- Flush Mounted On-Off Lever
- Teardrop Shaped Head
- Full Polish Chrome Handle
- Bright Chrome Finish
- Meets or Exceeds ASME B107.10



Cat. No.	UPC No.	Packaging	Tooth Count	Product Weight
81229	099575812293	Carded	84	2.20 lb

Cat. No.	Description	Cat. No.	Description
81213F	3/8" Drive Cushion Grip Offset Flex Handle Ratchet	80547	13/16" x 6" Swivel Spark Plug Socket
80546	5/8" x 6" Swivel Spark Plug Socket		

GEARWRENCH® 3/8" Drive 120XP™ Teardrop Ratchet



- 120 Positions, 3° Ratcheting Arc
- The Gear is Alternately Engaged by the Double-Stacked Pawls which give a 3° Swing Arc for Faster Work
- Highly Visible On/Off Markings on the Head
- Enclosed Head Design for Extreme Resistance to Dirt Infiltration
- Double-Stacked Pawls Engage a 60-tooth Gear Providing Exceptional Strength, Exceeding ASME Specifications
- Teardrop Low Profile Head and Flush Mounted On/Off Switch Allow Better Access in Tight Spaces
- Longer Reach Handle to Access Hard to Reach Fasteners
- Full Polish Chrome Handle
- Meets or Exceeds ASME B107.10



Cat. No.	UPC No.	Packaging	Overall Length	Head Width	Head Thickness	No. of Positions	Repair Kit	Product Weight
81211P	099575822223	Carded	8.386	1.22 in	0.55 in	120	81227P	0.79 lb

GEARWRENCH® 3/8" Drive 120XP™ Flex Head Teardrop Ratchet



- 120 Positions, 3° Ratcheting Arc
- The Gear is Alternately Engaged by the Double-Stacked Pawls which give a 3° Swing Arc for Faster Work
- 6-Position Flex Head for Adjustable Access Angle
- Highly Visible On/Off Markings on the Head
- Enclosed Head Design for Extreme Resistance to Dirt Infiltration
- Double-Stacked Pawls Engage a 60-tooth Gear Providing Exceptional Strength, Exceeding ASME Specifications
- Teardrop Low Profile Head and Flush Mounted On/Off Switch Allow Better Access in Tight Spaces
- Longer Reach Handle to Access Hard to Reach Fasteners
- Full polish Chrome Handle
- Meets or Exceeds ASME B107.10



Cat. No.	UPC No.	Packaging	Overall Length	Head Width	Head Thickness	No. of Positions	Repair Kit	Product Weight
81215P	099575012150	Carded	11.47 in	1.30 in	0.55 in	120	81227P	1.10 lb

GEARWRENCH® 3/8" Drive Full Polish Teardrop Ratchet

- 84 Tooth Flush Mounted On-Off Lever
- Teardrop Shaped Head
- Full Polish Chrome Handle Ratchet
- Bright Chrome Finish
- Meets or Exceeds ASME B107.10



Cat. No.	UPC No.	Packaging	Overall Length	Head Width	Head Thickness	Tooth Count	Repair Kit	Product Weight
81211F	099575810008	Carded	8.390 in	1.25 in	0.47 in	84	81227F	0.68 lb

GEARWRENCH® 3/8" Drive Long Handle Full Polish Teardrop Ratchet

- Full Polish Chrome, Long Handle for Increased Access
- Flush Mounted On-Off Lever
- Teardrop Shaped Head
- Full Polish Chrome Finish
- Meets or Exceeds ASME B107.10



Cat. No.	UPC No.	Packaging	Overall Length	Head Width	Head Thickness	Repair Kit	Product Weight
81264	099575812644	Carded	11.0 in	1.25 in	0.47 in	81227F	0.81 lb

GEARWRENCH® 3/8" Drive Full Polish Flex Teardrop Ratchet

- 84 Tooth Full Polish Chrome Handle Ratchet
- Flush Mounted On-Off Lever
- Teardrop Shaped Head Ratchet
- Bright Chrome Finish
- Meets or Exceeds ASME B107.10



Cat. No.	UPC No.	Packaging	Overall Length	Head Width	Head Thickness	Tooth Count	Repair Kit	Product Weight
81215F	099575811159	Carded	13.01 in	1.25 in	0.47 in	84	81227F	0.85 lb

GEARWRENCH® 3/8" Drive Full Polish Stubby Teardrop Ratchet

- 84 Tooth Full Polish Chrome Handle Ratchet
- Flush Mounted On-Off Lever
- Teardrop Shaped Head
- Bright Chrome Finish
- Meets or Exceeds ASME B107.10



Cat. No.	UPC No.	Packaging	Overall Length	Head Width	Head Thickness	Tooth Count	Repair Kit	Product Weight
81209F	099575821196	Carded	4.72 in	1.25 in	0.47 in	84	81227F	0.41 lb

GEARWRENCH® 3/8" Drive 120XP™ Full Polish Teardrop Stubby Flex Head Ratchet **120XP**

- 120 Positions, 3° Ratcheting Arc
- The Gear is Alternately Engaged by the Double-Stacked Pawls which give a 3° Swing Arc for Faster Work
- 6-Position Flex Head for Adjustable Access Angle
- Highly Visible On/Off Markings on the Head
- Enclosed Head Design for Extreme Resistance to Dirt Infiltration
- Double-Stacked Pawls Engage a 60-tooth Gear Providing Exceptional Strength, Exceeding ASME Specifications
- Teardrop Low Profile Head and Flush Mounted On/Off Switch Allow Better Access in Tight Spaces
- Longer Reach Handle to Access Hard to Reach Fasteners
- Full polish Chrome Handle
- Meets or Exceeds ASME B107.10



Cat. No.	UPC No.	Packaging	Overall Length	Head Width	Head Thickness	No. of Positions	Repair Kit	Product Weight
81212P	099575012129	Carded	5.00 in	1.30 in	0.55 in	120	81227P	0.55 lb

GEARWRENCH® 3/8" Drive Full Polish Stubby Flex Teardrop Ratchet

- 84 Tooth Full Polish Chrome Handle Ratchet
- Flush Mounted On-Off Lever
- Teardrop Shaped Head
- Bright Chrome Finish
- Meets or Exceeds ASME B107.10



Cat. No.	UPC No.	Packaging	Overall Length	Head Width	Head Thickness	Tooth Count	Repair Kit	Product Weight
81212F	099575811029	Carded	5.020 in	1.25 in	0.47 in	84	81227F	0.52 lb

GEARWRENCH® 3/8" Drive Full Polish Offset Flex Teardrop Ratchet

- 84 Tooth Full Polish Chrome Handle Ratchet
- Flush Mounted On-Off Lever
- Teardrop Shaped Head
- Bright Chrome Finish
- Meets or Exceeds ASME B107.10



Cat. No.	UPC No.	Packaging	Overall Length	Head Width	Head Thickness	Tooth Count	Repair Kit	Product Weight
81214F	099575821141	Carded	11.0 in	1.25 in	0.47 in	84	81227F	0.90 lb

GEARWRENCH® 3/8" Drive Quick-Release Teardrop Ratchet

- Quick-Release Drive Tool Retention
- Teardrop Shaped Head
- Full Polish Chrome Handle
- Bright Chrome Finish
- Meets or Exceeds ASME B107.10



Cat. No.	UPC No.	Packaging	Overall Length	Head Width	Head Thickness	Tooth Count	Product Weight
81218	099575812187	Carded	7.87 in	1.25 in	0.57 in	45	0.85 lb

GEARWRENCH® 3/8" Drive Quick-Release Flex Teardrop Ratchet

- Quick-Release Drive Tool Retention
- Teardrop Shaped Head
- Full Polish Chrome Handle
- Bright Chrome Finish
- Meets or Exceeds ASME B107.10



Cat. No.	UPC No.	Packaging	Overall Length	Head Width	Head Thickness	Tooth Count	Product Weight
81219	099575812194	Carded	10.3 in	1.22 in	0.57 in	45	1.10 lb

GEARWRENCH® 3/8" Drive Cushion Grip Teardrop Ratchet

- Flush Mounted On-Off Lever
- 84 Tooth Teardrop Shaped Head
- Dual Material Comfort Grip Handle
- Bright Chrome Finish
- Meets or Exceeds ASME B107.10



Cat. No.	UPC No.	Packaging	Overall Length	Head Width	Head Thickness	Tooth Count	Repair Kit	Product Weight
81208F	099575811081	Carded	9.02 in	1.25 in	0.47 in	84	81227F	0.64 lb

GEARWRENCH® 3/8" Drive Long Handle Cushion Grip Teardrop Ratchet

- Dual Material Comfort Grip, Long Handle for Increased Access
- Flush Mounted On-Off Lever
- Teardrop Shaped Head
- Full Polish Chrome Finish
- Meets or Exceeds ASME B107.10



Cat. No.	UPC No.	Packaging	Overall Length	Head Width	Head Thickness	Tooth Count	Repair Kit	Product Weight
81265	099575812651	Carded	13.0 in	1.25 in	0.47 in	84	81227F	0.77 lb

GEARWRENCH® 3/8" Drive 120XP™ Cushion Grip Teardrop Flex Head Ratchet



- 120 Positions, 3° Ratcheting Arc
- The Gear is Alternately Engaged by the Double-Stacked Pawls which give a 3° Swing Arc for Faster Work
- Highly Visible On/Off Markings on the Head
- Enclosed Head Design for Extreme Resistance to Dirt Infiltration
- Double-Stacked Pawls Engage a 60-tooth Gear Providing Exceptional Strength, Exceeding ASME Specifications
- Teardrop Low Profile Head and Flush Mounted On/Off Switch Allow Better Access in Tight Spaces
- Longer Reach Handle to Access Hard to Reach Fasteners
- Dual Material Comfort Grip Handle
- Meets or Exceeds ASME B107.10



Cat. No.	UPC No.	Packaging	Overall Length	Head Width	Head Thickness	No. of Positions	Repair Kit	Product Weight
81210P	099575012105	Carded	13.58 in	1.30 in	0.55 in	120	81227P	0.99 lb

GEARWRENCH® 3/8" Drive Cushion Grip Flex Teardrop Ratchet

- Flush Mounted On-Off Lever
- 84 Tooth Teardrop Shaped Head
- Dual Material Comfort Grip Handle
- Bright Chrome Finish
- Meets or Exceeds ASME B107.10



Cat. No.	UPC No.	Packaging	Overall Length	Head Width	Head Thickness	Tooth Count	Repair Kit	Product Weight
81210F	099575811104	Carded	13.130 in	1.25 in	0.47 in	84	81227F	0.94 lb

GEARWRENCH® 3/8" Drive Cushion Grip Offset Flex Teardrop Ratchet

- Flush Mounted On-Off Lever
- 84 Tooth Teardrop Shaped Head
- Dual Material Comfort Grip Handle
- Bright Chrome Finish
- Meets or Exceeds ASME B107.10



Cat. No.	UPC No.	Packaging	Overall Length	Head Width	Head Thickness	Tooth Count	Repair Kit	Product Weight
81213F	099575831119	Carded	12.260 in	1.25 in	0.48 in	84	81227F	0.99 lb

GEARWRENCH® 3/8" Drive Cushion Grip Roto Ratchet

- 360 Degree Rotating Head for Speed and Access
- Round Shaped Head
- Dual Material Comfort Grip Handle
- Bright Chrome Finish
- Meets or Exceeds ASME B107.10



Cat. No.	UPC No.	Packaging	Overall Length	Head Width	Head Thickness	Tooth Count	Product Weight
81225	099575812255	Carded	9.840 in	1.72 in	0.71 in	72	0.85 lb

GEARWRENCH® 3/8" Drive Gimbal Ratchet

- Gimbal Design Allows Ratchet to Pivot in Two Directions for Easier Access
- 72-Tooth Ratcheting Mechanism for 5 Degree Swing Arc
- Anodised Aluminum Finish
- Easy to Use Forward/Reverse Lever
- Meets or exceeds ASME performance requirements



Cat. No.	UPC No.	Packaging	Tooth Count	Product Weight
81270	099575817205	Carded	72	0.21 lb

GEARWRENCH® 3/8" Drive Thumbwheel Ratchet

- 72 Tooth Gear for 5 Degree Ratchet Angle
- Reversing Lever
- Contoured Handle for Maximum Grip Force



Cat. No.	UPC No.	Packaging	Tooth Count	Product Weight
81226	099575812262	Carded	72	0.25 lb

GEARWRENCH® 3/8" Drive Ratchet Repair Kits

For Non-Quick Release and Non-Roto Ratchets



Cat. No.	UPC No.	Packaging	Description	Fits Product Number	Tooth Count	No. of Positions	Product Weight
81227F	099575822070	Bagged	3/8" Drive Non-Quick Release Ratchet Repair Kit	81211, 81215, 81209, 81212, 81214, 81211F, 81215F, 81209F, 81212F, 81214F	84	-	0.08 lb
81227P	099575821271	Bagged	3/8" Drive Non-Quick Release Ratchet Repair Kit Dual Pawl 120XP	81210P, 81211P, 81212P, 81215P	-	120	0.12 lb

GEARWRENCH® 3/8" Drive Full Polish Flex Handle / Breaker Bar

- Full Polish Chrome Finish
- Ergonomic Handle
- Meets or Exceeds ASME B107.10



Cat. No.	UPC No.	Packaging	Overall Length	Product Weight
81221	099575812217	Carded	12 in	0.85 lb

GEARWRENCH® 3/8" Drive Universal Joint

- Universal Joint Allows for Greater Access
- Full Polish Chrome Finish Cleans Easily and Resists Corrosion



Cat. No.	UPC No.	Packaging	Overall Length	Female Drive Size	Male Drive Size	Product Weight
80549	099575805493	Carded	2 in	3/8"	3/8"	0.15 lb

GEARWRENCH® 3/8" Drive Magnetic Universal Joint

- Strong Magnetic Tips Allow for Contact Through the Base of the Socket to Hold Nuts and Bolts in Place During Use
- Universal Joint Allows for Greater Access
- Full Polish Chrome Finish Cleans Easily and Resists Corrosion



Cat. No.	UPC No.	Packaging	Overall Length	Female Drive Size	Male Drive Size	Product Weight
81256	099575812569	Carded	2.375 in	3/8"	3/8"	0.15 lb

3 / 8 "

3

RATCHETS / SOCKETS / DRIVE TOOLS / SETS

GEARWRENCH® 3/8" Drive Adapters

- Full Polish Chrome Finish Cleans Easily and Resists Corrosion



Cat. No.	UPC No.	Packaging	Overall Length	Female Drive Size	Male Drive Size	Product Weight
81277	099575812774	Carded	1.00 in	3/8"	1/4"	0.40 lb
81278	099575812781	Carded	1.44 in	3/8"	1/2"	0.11 lb

GEARWRENCH® 3/8" Drive Magnetic Adapters

- Magnetic Tip Keeps the Fastener in the Sockets
- Full Polish Chrome Finish Cleans Easily and Resists Corrosion



Cat. No.	UPC No.	Packaging	Female Drive Size	Male Drive Size	Product Weight
81259	099575812590	Carded	3/8"	1/4"	0.25 lb
81260	099575812606	Carded	3/8"	1/2"	0.25 lb

GEARWRENCH® 3/8" Drive SAE Spark Plug Sockets

- Surface Drive® Reduces Fastener Rounding
- Full Polish Chrome Finish
- Meets or Exceeds ASME B107.34



Cat. No.	UPC No.	Packaging	Description	Product Weight
80402	099575804021	Carded	3/8" Drive Spark Plug Socket 5/8"	0.22 lb
80403	099575804038	Carded	3/8" Drive Spark Plug Socket 13/16"	0.35 lb

GEARWRENCH® 3/8" Drive SAE Swivel Magnetic Spark Plug Sockets

- Surface Drive® Reduces Fastener Rounding
- Full Polish Chrome Finish
- Meets or Exceeds ASME B107.34



Cat. No.	UPC No.	Packaging	Fastener Size	Dim. A: Drive End Hex Across Flats	Dim. B: Nose Diameter	Dim. C: Overall Length	Dim. E: Wrench Depth	Product Weight
80404	099575804045	Carded	5/8 in	0.748 in	0.890 in	2.500 in	0.905 in	0.24 lb
80405	099575804052	Carded	13/16 in	0.874 in	1.080 in	2.750 in	1.023 in	0.33 lb
80546	099575805462	Carded	5/8 in	0.748 in	0.866 in	6.000 in	1.810 in	0.43 lb
80547	099575805479	Carded	13/16 in	0.874 in	1.102 in	6.000 in	1.800 in	0.53 lb

GEARWRENCH® 3/8" Drive Standard Extension

- Knurled Grip Provides Non-Slip Surface
- Full Polish Chrome Finish



Cat. No.	UPC No.	Packaging	Length	Wobble	Product Weight
81240	099575812408	Carded	1.5 in	No	0.07 lb
81241	099575812415	Carded	3 in	No	0.15 lb
81242	099575812422	Carded	6 in	No	0.31 lb
81243	099575812439	Carded	10 in	No	0.51 lb
81244	099575812446	Carded	12 in	No	0.55 lb

GEARWRENCH® 3/8" Drive Speeder Handle

- Professional, Full Polish Finish
- Spinner Handle Design for Ultra Fast Action



Cat. No.	UPC No.	Packaging	Length	Product Weight
81239	099575812392	Carded	16.75 in	1.55 lb

GEARWRENCH® 4 Pc. 3/8" Drive Extension Set

- Knurled Grip Provides Non-Slip Surface
- Full Polish Chrome Finish



Cat. No.	UPC No.	Packaging	Product Weight
81200D	099575812002	Carded	1.32 lb

Cat. No.	Description	Cat. No.	Description
81240	3/8" Drive Standard Extension 1.5"	81242	3/8" Drive Standard Extension 6"
81241	3/8" Drive Standard Extension 3"	81244	3/8" Drive Standard Extension 12"

GEARWRENCH® 3/8" Drive Magnetic Extension

- Knurled Grip Provides Non-Slip Surface
- Strong Magnetic Tips Allow for Contact Through the Base of the Socket to Hold Nuts and Bolts in Place During Use
- Full Polish Chrome Finish



Cat. No.	UPC No.	Packaging	Length	Wobble	Product Weight
81262	099575812620	Carded	6 in	No	0.32 lb

GEARWRENCH® 3/8" Drive Wobble Extension

- Knurled Grip Provides Non-Slip Surface
- Full Polish Chrome Finish



Cat. No.	UPC No.	Packaging	Length	Wobble	Product Weight
81245	099575812453	Carded	1.5 in	Yes	0.07 lb
81246	099575812460	Carded	3 in	Yes	0.15 lb
81247	099575812477	Carded	6 in	Yes	0.31 lb
81248	099575812484	Carded	10 in	Yes	0.51 lb
81249	099575812491	Carded	12 in	Yes	0.55 lb

GEARWRENCH® 4 Pc. 3/8" Drive Wobble Extension Set

- Use as either Standard Extension when Fully Inserted in Socket or as a Wobble Extension when Partially Inserted
- Knurled Grip Provides Non-Slip Surface
- Full Polish Chrome Finish



Cat. No.	UPC No.	Packaging	Product Weight
81201	099575812019	Carded	1.32 lb

Cat. No.	Description	Cat. No.	Description
81246	3/8" Drive Wobble Extension 3"	81248	3/8" Drive Wobble Extension 10"
81247	3/8" Drive Wobble Extension 6"	81249	3/8" Drive Wobble Extension 12"

GEARWRENCH® 3/8" Drive Locking Extensions

- Knurled Grip Provides Non-Slip Surface



Cat. No.	UPC No.	Packaging	Length	Wobble	Product Weight
81250	099575812507	Carded	3 in	No	0.15 lb
81251	099575812514	Carded	6 in	No	0.31 lb
81272	099575812729	Carded	10 in	No	0.51 lb

GEARWRENCH® 3 Pc. 3/8" Drive Locking Extension Set

- Knurled Grip Provides Non-Slip Surface



Cat. No.	UPC No.	Packaging	Product Weight
81202	099575812026	Carded	1.10 lb

Cat. No.	Description	Cat. No.	Description
81250	3/8" Drive Locking Extension 3"	81272	3/8" Drive Locking Extension 10"
81251	3/8" Drive Locking Extension 6"		

GEARWRENCH® 3/8" Drive 6 and 12 Point SAE Standard Length Sockets

- Surface Drive® Technology Reduces Fastener Rounding
- Chamfered Opening to Guide Fastener Into Socket
- Large Hard-Stamped Size Identification
- Double Line (SAE) and Knurled (Metric) Ring to Easily Identify Standard vs. Metric Sockets
- Full Polish Chrome Finish Cleans Easily and Resists Corrosion
- Meets or Exceeds ASME B107.1

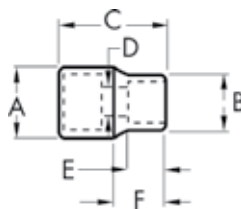

Cat. No.	UPC No.	Packaging	Drive Type	Fastener Size	Dim. A: Drive End	Dim. B: Wrench End	Dim. C: Overall Length	Dim. D: Bolt Clearance	Dim. E: Wrench Depth	Dim. F: Length to Shoulder	Product Weight
80350	099575803505	Carded	6 Point	1/4 in	0.677 in	0.394 in	0.984 in	0.197 in	0.295 in	0.453 in	0.04 lb
80351	099575803512	Carded	6 Point	5/16 in	0.677 in	0.461 in	0.984 in	0.283 in	0.295 in	0.453 in	0.04 lb
80352	099575803529	Carded	6 Point	3/8 in	0.677 in	0.543 in	0.984 in	0.283 in	0.295 in	0.453 in	0.04 lb
80353	099575803536	Carded	6 Point	7/16 in	0.677 in	0.630 in	0.984 in	0.354 in	0.295 in	0.453 in	0.04 lb
80354	099575803543	Carded	6 Point	1/2 in	0.705 in	0.685 in	0.984 in	0.354 in	0.295 in	0.453 in	0.07 lb
80355	099575803550	Carded	6 Point	9/16 in	0.776 in	0.776 in	0.984 in	0.354 in	0.492 in	0.453 in	0.07 lb
80356	099575803567	Carded	6 Point	5/8 in	0.874 in	0.874 in	0.984 in	0.354 in	0.492 in	0.453 in	0.11 lb
80357	099575803574	Carded	6 Point	11/16 in	0.941 in	0.941 in	0.984 in	0.354 in	0.492 in	0.453 in	0.11 lb
80358	099575803581	Carded	6 Point	3/4 in	1.020 in	1.020 in	0.984 in	0.354 in	0.492 in	0.453 in	0.13 lb
80359	099575803598	Carded	6 Point	13/16 in	1.098 in	1.098 in	1.102 in	0.354 in	0.591 in	0.453 in	0.18 lb
80360	099575803604	Carded	6 Point	7/8 in	1.169 in	1.169 in	1.102 in	0.354 in	0.591 in	0.453 in	0.20 lb
80361	099575803611	Carded	6 Point	15/16 in	1.256 in	1.256 in	1.161 in	0.354 in	0.591 in	0.453 in	0.24 lb
80362	099575803628	Carded	6 Point	1 in	1.335 in	1.335 in	1.319 in	0.354 in	0.709 in	0.453 in	0.29 lb
80496	099575804960	Carded	12 Point	1/4 in	0.677 in	0.394 in	0.984 in	0.197 in	0.295 in	0.453 in	0.04 lb
80497D	099575804977	Carded	12 Point	5/16 in	0.677 in	0.461 in	0.984 in	0.283 in	0.295 in	0.453 in	0.04 lb
80498	099575804984	Carded	12 Point	3/8 in	0.677 in	0.543 in	0.984 in	0.283 in	0.295 in	0.453 in	0.05 lb
80499	099575804991	Carded	12 Point	7/16 in	0.677 in	0.630 in	0.984 in	0.354 in	0.295 in	0.453 in	0.05 lb
80500D	099575805004	Carded	12 Point	1/2 in	0.705 in	0.685 in	0.984 in	0.354 in	0.295 in	0.453 in	0.06 lb
80501	099575805011	Carded	12 Point	9/16 in	0.776 in	0.776 in	0.984 in	0.354 in	0.492 in	0.453 in	0.07 lb
80502	099575805028	Carded	12 Point	5/8 in	0.874 in	0.874 in	0.984 in	0.354 in	0.492 in	0.453 in	0.09 lb
80503	099575805035	Carded	12 Point	11/16 in	0.941 in	0.941 in	0.984 in	0.354 in	0.492 in	0.453 in	0.10 lb
80504	099575805042	Carded	12 Point	3/4 in	1.020 in	1.020 in	0.984 in	0.354 in	0.492 in	0.453 in	0.12 lb
80505	099575805059	Carded	12 Point	13/16 in	1.098 in	1.098 in	1.102 in	0.354 in	0.591 in	0.453 in	0.15 lb
80506D	099575805066	Carded	12 Point	7/8 in	1.169 in	1.169 in	1.102 in	0.354 in	0.591 in	0.453 in	0.15 lb
80507	099575805073	Carded	12 Point	15/16 in	1.256 in	1.256 in	1.161 in	0.354 in	0.591 in	0.453 in	0.15 lb
80508	099575805080	Carded	12 Point	1 in	1.335 in	1.335 in	1.319 in	0.354 in	0.709 in	0.453 in	0.16 lb

GEARWRENCH® 3/8" Drive 6 and 12 Point Metric Standard Length Sockets

- Surface Drive® Technology Reduces Fastener Rounding
- Chamfered Opening to Guide Fastener Into Socket
- Large Hard-Stamped Size Identification
- Double Line (SAE) and Knurled (Metric) Ring to Easily Identify Standard vs. Metric Sockets
- Full Polish Chrome Finish Cleans Easily and Resists Corrosion
- Meets or Exceeds ASME B107.5M

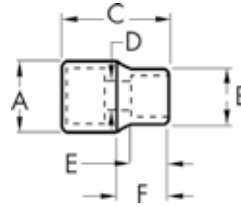

Cat. No.	UPC No.	Packaging	Drive Type	Fastener Size	Dim. A: Drive End	Dim. B: Wrench End	Dim. C: Overall Length	Dim. D: Bolt Clearance	Dim. E: Wrench Depth	Dim. F: Length to Shoulder	Product Weight
80374	099575803741	Carded	6 Point	6 mm	0.669 in	0.366 in	0.984 in	0.197 in	0.295 in	0.453 in	0.04 lb
80375	099575803758	Carded	6 Point	7 mm	0.669 in	0.425 in	0.984 in	0.197 in	0.295 in	0.453 in	0.03 lb
80376	099575803765	Carded	6 Point	8 mm	0.669 in	0.472 in	0.984 in	0.283 in	0.295 in	0.453 in	0.03 lb
80377	099575803772	Carded	6 Point	9 mm	0.669 in	0.508 in	0.984 in	0.283 in	0.295 in	0.453 in	0.04 lb
80378	099575803789	Carded	6 Point	10 mm	0.669 in	0.571 in	0.984 in	0.283 in	0.295 in	0.453 in	0.04 lb
80379	099575803796	Carded	6 Point	11 mm	0.669 in	0.622 in	0.984 in	0.354 in	0.295 in	0.453 in	0.03 lb
80380	099575803802	Carded	6 Point	12 mm	0.669 in	0.654 in	0.984 in	0.354 in	0.315 in	0.453 in	0.03 lb
80381	099575803819	Carded	6 Point	13 mm	0.720 in	0.697 in	0.984 in	0.354 in	0.315 in	0.453 in	0.06 lb
80382	099575803826	Carded	6 Point	14 mm	0.768 in	0.768 in	0.984 in	0.354 in	0.492 in	0.453 in	0.06 lb
80383	099575803833	Carded	6 Point	15 mm	0.819 in	0.819 in	0.984 in	0.354 in	0.492 in	0.453 in	0.07 lb
80384	099575803840	Carded	6 Point	16 mm	0.866 in	0.866 in	0.984 in	0.354 in	0.492 in	0.453 in	0.08 lb
80385	099575803857	Carded	6 Point	17 mm	0.917 in	0.917 in	0.984 in	0.354 in	0.492 in	0.453 in	0.11 lb
80386	099575803864	Carded	6 Point	18 mm	0.937 in	0.937 in	0.984 in	0.354 in	0.492 in	0.453 in	0.11 lb
80387	099575803871	Carded	6 Point	19 mm	0.937 in	0.937 in	0.984 in	0.354 in	0.492 in	0.453 in	0.13 lb
80330	099575803307	Carded	6 Point	20 mm	1.016 in	1.063 in	1.102 in	0.354 in	0.591 in	0.453 in	0.17 lb
80331	099575803314	Carded	6 Point	21 mm	1.051 in	1.098 in	1.102 in	0.354 in	0.591 in	0.453 in	0.19 lb
80332	099575803321	Carded	6 Point	22 mm	1.114 in	1.161 in	1.102 in	0.354 in	0.591 in	0.453 in	0.22 lb
80482	099575804823	Carded	12 Point	6 mm	0.669 in	0.366 in	0.984 in	0.197 in	0.295 in	0.453 in	0.04 lb
80483	099575804830	Carded	12 Point	7 mm	0.669 in	0.425 in	0.984 in	0.197 in	0.295 in	0.453 in	0.03 lb
80484	099575804847	Carded	12 Point	8 mm	0.669 in	0.472 in	0.984 in	0.283 in	0.295 in	0.453 in	0.03 lb
80485	099575804854	Carded	12 Point	9 mm	0.669 in	0.508 in	0.984 in	0.283 in	0.295 in	0.453 in	0.04 lb
80486	099575804861	Carded	12 Point	10 mm	0.669 in	0.571 in	0.984 in	0.283 in	0.295 in	0.453 in	0.04 lb
80487	099575804878	Carded	12 Point	11 mm	0.669 in	0.622 in	0.984 in	0.354 in	0.295 in	0.453 in	0.03 lb
80488	099575804885	Carded	12 Point	12 mm	0.669 in	0.654 in	0.984 in	0.354 in	0.315 in	0.453 in	0.03 lb
80489	099575804892	Carded	12 Point	13 mm	0.720 in	0.697 in	0.984 in	0.354 in	0.315 in	0.453 in	0.06 lb
80490	099575804908	Carded	12 Point	14 mm	0.768 in	0.768 in	0.984 in	0.354 in	0.492 in	0.453 in	0.06 lb
80491	099575804915	Carded	12 Point	15 mm	0.819 in	0.819 in	0.984 in	0.354 in	0.492 in	0.453 in	0.07 lb
80492	099575804922	Carded	12 Point	16 mm	0.866 in	0.866 in	0.984 in	0.354 in	0.492 in	0.453 in	0.08 lb
80493	099575804939	Carded	12 Point	17 mm	0.917 in	0.917 in	0.984 in	0.354 in	0.492 in	0.453 in	0.11 lb
80494	099575804946	Carded	12 Point	18 mm	0.937 in	0.937 in	0.984 in	0.354 in	0.492 in	0.453 in	0.11 lb
80495	099575804953	Carded	12 Point	19 mm	0.957 in	1.004 in	0.984 in	0.354 in	0.492 in	0.453 in	0.13 lb
80596	099575805967	Carded	12 Point	20 mm	1.016 in	1.063 in	1.102 in	0.354 in	0.591 in	0.453 in	0.17 lb
80597	099575805974	Carded	12 Point	21 mm	1.051 in	1.098 in	1.102 in	0.354 in	0.591 in	0.453 in	0.19 lb
80598	099575805981	Carded	12 Point	22 mm	1.114 in	1.161 in	1.102 in	0.354 in	0.591 in	0.453 in	0.22 lb

3 / 8 "

3

RATCHETS / SOCKETS / DRIVE TOOLS / SETS

GEARWRENCH® 3/8" Drive 6 Point SAE Mid Length Sockets

- Mid Length Design for Access to Difficult Fasteners
- Surface Drive® Technology Reduces Fastener Rounding
- Chamfered Opening to Guide Fastener Into Socket
- Large Hard-Stamped Size Identification
- Double Line (SAE) and Knurled (Metric) Ring to Easily Identify Standard vs. Metric Sockets
- Full Polish Chrome Finish Cleans Easily and Resists Corrosion
- Meets or Exceeds ASME B107.1

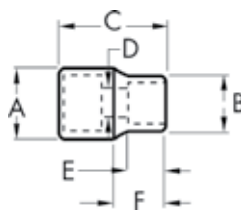

Cat. No.	UPC No.	Packaging	Drive Type	Fastener Size	Dim. A: Drive End	Dim. B: Wrench End	Dim. C: Overall Length	Dim. D: Bolt Clearance	Dim. E: Wrench Depth	Dim. F: Length to Shoulder	Product Weight
80363S	099575823633	Carded	6 Point	1/4 in	0.66 in	0.39 in	1.81 in	0.18 in	0.35 in	1.02 in	0.07 lb
80364S	099575823640	Carded	6 Point	5/16 in	0.66 in	0.46 in	1.81 in	0.20 in	0.51 in	1.02 in	0.07 lb
80365S	099575823657	Carded	6 Point	3/8 in	0.66 in	0.54 in	1.81 in	0.30 in	0.63 in	1.02 in	0.08 lb
80366S	099575823664	Carded	6 Point	7/16 in	0.66 in	0.62 in	1.81 in	0.35 in	0.63 in	1.02 in	0.09 lb
80367S	099575823671	Carded	6 Point	1/2 in	0.74 in	0.74 in	1.81 in	0.43 in	0.83 in	-	0.12 lb
80368S	099575823688	Carded	6 Point	9/16 in	0.78 in	0.78 in	1.81 in	0.47 in	0.83 in	-	0.13 lb
80369S	099575823695	Carded	6 Point	5/8 in	0.81 in	0.86 in	1.81 in	0.55 in	0.83 in	-	0.16 lb
80370S	099575823701	Carded	6 Point	11/16 in	0.87 in	0.94 in	1.81 in	0.59 in	0.83 in	-	0.19 lb
80371S	099575823718	Carded	6 Point	3/4 in	0.94 in	1.02 in	1.81 in	0.67 in	0.83 in	-	0.22 lb
80372S	099575823725	Carded	6 Point	13/16 in	0.98 in	1.09 in	1.81 in	0.75 in	1.02 in	-	0.25 lb
80373S	099575823732	Carded	6 Point	7/8 in	1.08 in	1.17 in	1.81 in	0.79 in	1.02 in	-	0.29 lb

GEARWRENCH® 3/8" Drive 6 Point Metric Mid Length Sockets

- Mid Length Design for Access to Difficult Fasteners
- Surface Drive® Technology Reduces Fastener Rounding
- Chamfered Opening to Guide Fastener Into Socket
- Large Hard-Stamped Size Identification
- Double Line (SAE) and Knurled (Metric) Ring to Easily Identify Standard vs. Metric Sockets
- Full Polish Chrome Finish Cleans Easily and Resists Corrosion
- Meets or Exceeds ASME B107.5M

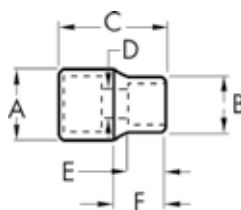

Cat. No.	UPC No.	Packaging	Drive Type	Fastener Size	Dim. A: Drive End	Dim. B: Wrench End	Dim. C: Overall Length	Dim. D: Bolt Clearance	Dim. E: Wrench Depth	Dim. F: Length to Shoulder	Product Weight
80388S	099575823886	Carded	6 Point	6 mm	0.66 in	0.39 in	1.81 in	0.16 in	0.35 in	1.02 in	0.07 lb
80389S	099575823893	Carded	6 Point	7 mm	0.66 in	0.42 in	1.81 in	0.2 in	0.35 in	1.02 in	0.08 lb
80390S	099575823909	Carded	6 Point	8 mm	0.66 in	0.47 in	1.81 in	0.24 in	0.59 in	1.02 in	0.07 lb
80391S	099575823916	Carded	6 Point	9 mm	0.66 in	0.52 in	1.81 in	0.28 in	0.59 in	1.02 in	0.08 lb
80392S	099575823923	Carded	6 Point	10 mm	0.66 in	0.56 in	1.81 in	0.31 in	0.63 in	1.02 in	0.08 lb
80393S	099575823930	Carded	6 Point	11 mm	0.66 in	0.62 in	1.81 in	0.35 in	0.63 in	1.02 in	0.08 lb
80394S	099575823947	Carded	6 Point	12 mm	0.70 in	0.70 in	1.81 in	0.39 in	0.83 in	-	0.11 lb
80395S	099575823954	Carded	6 Point	13 mm	0.74 in	0.74 in	1.81 in	0.43 in	0.83 in	-	0.12 lb
80396S	099575823961	Carded	6 Point	14 mm	0.78 in	0.78 in	1.81 in	0.47 in	0.83 in	-	0.13 lb
80397S	099575823978	Carded	6 Point	15 mm	0.81 in	0.81 in	1.81 in	0.51 in	0.83 in	-	0.16 lb
80398S	099575823985	Carded	6 Point	16 mm	0.81 in	0.81 in	1.81 in	0.55 in	0.83 in	-	0.15 lb
80399S	099575823992	Carded	6 Point	17 mm	0.87 in	0.87 in	1.81 in	0.59 in	0.83 in	-	0.19 lb
80400S	099575834004	Carded	6 Point	18 mm	0.91 in	0.91 in	1.81 in	0.63 in	0.83 in	-	0.21 lb
80401S	099575854019	Carded	6 Point	19 mm	0.94 in	0.94 in	1.81 in	0.67 in	0.83 in	-	0.22 lb

3 / 8 "

3

RATCHETS / SOCKETS / DRIVE TOOLS / SETS

GEARWRENCH® 3/8" Drive 6 and 12 Point SAE Deep Length Sockets

- Surface Drive® Technology Reduces Fastener Rounding
- Chamfered Opening to Guide Fastener Into Socket
- Large Hard-Stamped Size Identification
- Double Line (SAE) and Knurled (Metric) Ring to Easily Identify Standard vs. Metric Sockets
- Full Polish Chrome Finish Cleans Easily and Resists Corrosion
- Meets or Exceeds ASME B107.1

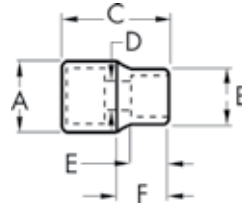

Cat. No.	UPC No.	Packaging	Drive Type	Fastener Size	Dim. A: Drive End	Dim. B: Wrench End	Dim. C: Overall Length	Dim. D: Bolt Clearance	Dim. E: Wrench Depth	Dim. F: Length to Shoulder	Product Weight
80363	099575803635	Carded	6 Point	1/4 in	0.661 in	0.394 in	2.500 in	0.217 in	0.157 in	1.142 in	0.11 lb
80364	099575803642	Carded	6 Point	5/16 in	0.661 in	0.461 in	2.500 in	0.276 in	0.197 in	1.142 in	0.11 lb
80365	099575803659	Carded	6 Point	3/8 in	0.661 in	0.543 in	2.500 in	0.335 in	0.201 in	1.142 in	0.12 lb
80366	099575803666	Carded	6 Point	7/16 in	0.661 in	0.630 in	2.500 in	0.335 in	0.236 in	1.142 in	0.13 lb
80367	099575803673	Carded	6 Point	1/2 in	0.720 in	0.685 in	2.500 in	0.335 in	0.287 in	1.142 in	0.15 lb
80368	099575803680	Carded	6 Point	9/16 in	0.780 in	0.780 in	2.500 in	0.335 in	0.350 in	1.142 in	0.18 lb
80369	099575803697	Carded	6 Point	5/8 in	0.866 in	0.866 in	2.500 in	0.335 in	0.398 in	1.142 in	0.24 lb
80370D	099575803703	Carded	6 Point	11/16 in	0.937 in	0.937 in	2.500 in	0.335 in	0.398 in	1.142 in	0.29 lb
80371	099575803710	Carded	6 Point	3/4 in	1.016 in	1.016 in	2.500 in	0.335 in	0.457 in	1.142 in	0.33 lb
80372	099575803727	Carded	6 Point	13/16 in	1.094 in	1.094 in	2.500 in	0.335 in	0.480 in	1.142 in	0.40 lb
80373	099575803734	Carded	6 Point	7/8 in	1.173 in	1.173 in	2.500 in	0.335 in	0.520 in	1.142 in	0.44 lb
80592	099575805929	Carded	6 Point	15/16 in	1.205 in	1.252 in	2.500 in	0.335 in	0.567 in	1.142 in	0.46 lb
80593	099575805936	Carded	6 Point	1 in	1.272 in	1.319 in	2.500 in	0.335 in	0.567 in	1.142 in	0.52 lb
80509	099575805097	Carded	12 Point	1/4 in	0.661 in	0.394 in	2.500 in	0.217 in	0.157 in	1.142 in	0.11 lb
80510D	099575805103	Carded	12 Point	5/16 in	0.661 in	0.461 in	2.500 in	0.276 in	0.197 in	1.142 in	0.11 lb
80511	099575805110	Carded	12 Point	3/8 in	0.661 in	0.543 in	2.500 in	0.335 in	0.201 in	1.142 in	0.12 lb
80512	099575805127	Carded	12 Point	7/16 in	0.661 in	0.630 in	2.500 in	0.335 in	0.236 in	1.142 in	0.13 lb
80513	099575805134	Carded	12 Point	1/2 in	0.720 in	0.685 in	2.500 in	0.335 in	0.287 in	1.142 in	0.15 lb
80514	099575805141	Carded	12 Point	9/16 in	0.780 in	0.780 in	2.500 in	0.335 in	0.350 in	1.142 in	0.18 lb
80515D	099575805158	Carded	12 Point	5/8 in	0.866 in	0.866 in	2.500 in	0.335 in	0.398 in	1.142 in	0.24 lb
80516	099575805165	Carded	12 Point	11/16 in	0.937 in	0.937 in	2.500 in	0.335 in	0.398 in	1.142 in	0.29 lb
80517	099575805172	Carded	12 Point	3/4 in	1.016 in	1.016 in	2.500 in	0.335 in	0.457 in	1.142 in	0.33 lb
80518	099575805189	Carded	12 Point	13/16 in	1.094 in	1.094 in	2.500 in	0.335 in	0.480 in	1.142 in	0.40 lb
80519	099575805196	Carded	12 Point	7/8 in	1.173 in	1.173 in	2.500 in	0.335 in	0.520 in	1.142 in	0.44 lb
80594	099575805943	Carded	12 Point	15/16 in	1.205 in	1.252 in	2.500 in	0.335 in	0.567 in	1.142 in	0.46 lb
80595	099575805950	Carded	12 Point	1 in	1.272 in	1.319 in	2.500 in	0.335 in	0.567 in	1.142 in	0.52 lb

3 / 8 "

3

RATCHETS / SOCKETS / DRIVE TOOLS / SETS

GEARWRENCH® 3/8" Drive 6 and 12 Point Metric Deep Length Sockets

- Surface Drive® Technology Reduces Fastener Rounding
- Chamfered Opening to Guide Fastener Into Socket
- Large Hard-Stamped Size Identification
- Double Line (SAE) and Knurled (Metric) Ring to Easily Identify Standard vs. Metric Sockets
- Full Polish Chrome Finish Cleans Easily and Resists Corrosion
- Meets or Exceeds ASME B107.5M

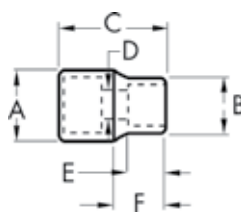

Cat. No.	UPC No.	Packaging	Drive Type	Fastener Size	Dim. A: Drive End	Dim. B: Wrench End	Dim. C: Overall Length	Dim. D: Bolt Clearance	Dim. E: Wrench Depth	Dim. F: Length to Shoulder	Product Weight
80388	099575803888	Carded	6 Point	6 mm	0.661 in	0.508 in	2.500 in	0.315 in	0.197 in	1.142 in	0.11 lb
80389	099575803895	Carded	6 Point	7 mm	0.661 in	0.508 in	2.500 in	0.315 in	0.197 in	1.142 in	0.11 lb
80390	099575803901	Carded	6 Point	8 mm	0.661 in	0.508 in	2.500 in	0.315 in	0.197 in	1.142 in	0.13 lb
80391	099575803918	Carded	6 Point	9 mm	0.661 in	0.508 in	2.500 in	0.315 in	0.197 in	1.142 in	0.13 lb
80392	099575803925	Carded	6 Point	10 mm	0.661 in	0.571 in	2.500 in	0.335 in	0.201 in	1.142 in	0.13 lb
80393D	099575803932	Carded	6 Point	11 mm	0.661 in	0.622 in	2.500 in	0.335 in	0.236 in	1.142 in	0.14 lb
80394D	099575803949	Carded	6 Point	12 mm	0.661 in	0.654 in	2.500 in	0.335 in	0.260 in	1.142 in	0.14 lb
80395	099575803956	Carded	6 Point	13 mm	0.740 in	0.697 in	2.500 in	0.335 in	0.287 in	1.142 in	0.16 lb
80396	099575803963	Carded	6 Point	14 mm	0.768 in	0.768 in	2.500 in	0.335 in	0.350 in	1.142 in	0.16 lb
80397	099575803970	Carded	6 Point	15 mm	0.819 in	0.819 in	2.500 in	0.335 in	0.350 in	1.142 in	0.17 lb
80398	099575803987	Carded	6 Point	16 mm	0.866 in	0.866 in	2.500 in	0.335 in	0.398 in	1.142 in	0.17 lb
80399	099575803994	Carded	6 Point	17 mm	0.937 in	0.937 in	2.500 in	0.335 in	0.398 in	1.142 in	0.19 lb
80400	099575804007	Carded	6 Point	18 mm	0.937 in	0.937 in	2.500 in	0.335 in	0.421 in	1.142 in	0.24 lb
80401	099575804014	Carded	6 Point	19 mm	1.004 in	1.004 in	2.500 in	0.335 in	0.457 in	1.142 in	0.25 lb
80406	099575804069	Carded	6 Point	20 mm	1.016 in	1.063 in	2.500 in	0.335 in	0.480 in	1.142 in	0.25 lb
80407	099575804076	Carded	6 Point	21 mm	1.047 in	1.094 in	2.500 in	0.335 in	0.480 in	1.142 in	0.26 lb
80408	099575804083	Carded	6 Point	22 mm	1.114 in	1.161 in	2.500 in	0.335 in	0.520 in	1.142 in	0.27 lb
80409	099575804090	Carded	6 Point	24 mm	1.205 in	1.252 in	2.500 in	0.335 in	0.567 in	1.142 in	0.28 lb
80520D	099575805202	Carded	12 Point	6 mm	0.661 in	0.394 in	2.500 in	0.217 in	0.157 in	1.142 in	0.11 lb
80521	099575805219	Carded	12 Point	7 mm	0.661 in	0.431 in	2.500 in	0.256 in	0.197 in	1.142 in	0.11 lb
80522	099575805226	Carded	12 Point	8 mm	0.661 in	0.472 in	2.500 in	0.276 in	0.197 in	1.142 in	0.13 lb
80523	099575805233	Carded	12 Point	9 mm	0.661 in	0.508 in	2.500 in	0.315 in	0.197 in	1.142 in	0.13 lb
80524	099575805240	Carded	12 Point	10 mm	0.661 in	0.571 in	2.500 in	0.335 in	0.201 in	1.142 in	0.13 lb
80525	099575805257	Carded	12 Point	11 mm	0.661 in	0.622 in	2.500 in	0.335 in	0.236 in	1.142 in	0.14 lb
80526	099575805264	Carded	12 Point	12 mm	0.661 in	0.654 in	2.500 in	0.335 in	0.260 in	1.142 in	0.14 lb
80527	099575805271	Carded	12 Point	13 mm	0.740 in	0.697 in	2.500 in	0.335 in	0.287 in	1.142 in	0.16 lb
80528	099575805288	Carded	12 Point	14 mm	0.768 in	0.768 in	2.500 in	0.335 in	0.350 in	1.142 in	0.16 lb
80529	099575805295	Carded	12 Point	15 mm	0.819 in	0.819 in	2.500 in	0.335 in	0.350 in	1.142 in	0.17 lb
80530	099575805301	Carded	12 Point	16 mm	0.866 in	0.866 in	2.500 in	0.335 in	0.398 in	1.142 in	0.17 lb
80531	099575805318	Carded	12 Point	17 mm	0.937 in	0.937 in	2.500 in	0.335 in	0.398 in	1.142 in	0.19 lb
80532	099575805325	Carded	12 Point	18 mm	0.937 in	0.937 in	2.500 in	0.335 in	0.421 in	1.142 in	0.24 lb
80533	099575805332	Carded	12 Point	19 mm	1.004 in	1.004 in	2.500 in	0.335 in	0.457 in	1.142 in	0.25 lb

GEARWRENCH® 3/8" Drive 6 Point SAE Flex Sockets

- Large Hard Stamped Identification
- Entry Angle Guides Fastener
- Full Polish Chrome Finish

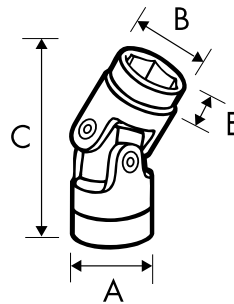

Cat. No.	UPC No.	Packaging	Fastener Size	Dim. A: Drive End	Dim. B: Wrench End	Dim. C: Overall Length	Dim. E: Wrench Depth	Product Weight
80343	099575803437	Carded	3/8 in	0.748 in	0.571 in	1.732 in	0.220 in	0.11 lb
80344	099575803444	Carded	7/16 in	0.748 in	0.610 in	1.811 in	0.270 in	0.12 lb
80345	099575803451	Carded	1/2 in	0.748 in	0.748 in	1.850 in	0.350 in	0.13 lb
80346	099575803468	Carded	9/16 in	0.748 in	0.787 in	1.890 in	0.320 in	0.13 lb
80347	099575803475	Carded	5/8 in	0.748 in	0.866 in	1.890 in	0.400 in	0.14 lb
80348	099575803482	Carded	11/16 in	0.748 in	0.957 in	1.890 in	0.400 in	0.16 lb
80349	099575803499	Carded	3/4 in	0.748 in	1.016 in	2.008 in	0.450 in	0.16 lb

GEARWRENCH® 3/8" Drive 6 Point Metric Flex Sockets

- Large Hard Stamped Identification
- Entry Angle Guides Fastener
- Full Polish Chrome Finish

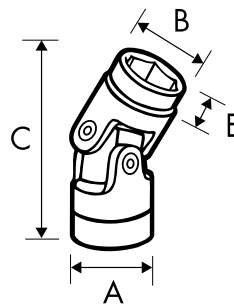

Cat. No.	UPC No.	Packaging	Fastener Size	Dim. A: Drive End	Dim. B: Wrench End	Dim. C: Overall Length	Dim. E: Wrench Depth	Product Weight
80333	099575803338	Carded	10 mm	0.748 in	0.331 in	1.772 in	0.280 in	0.12 lb
80334	099575803345	Carded	11 mm	0.748 in	0.337 in	1.772 in	0.300 in	0.12 lb
80335	099575803352	Carded	12 mm	0.748 in	0.378 in	1.850 in	0.320 in	0.12 lb
80336	099575803369	Carded	13 mm	0.748 in	0.425 in	1.890 in	0.290 in	0.13 lb
80337	099575803376	Carded	14 mm	0.748 in	0.465 in	1.890 in	0.350 in	0.13 lb
80338	099575803383	Carded	15 mm	0.748 in	0.500 in	1.890 in	0.370 in	0.13 lb
80339	099575803390	Carded	16 mm	0.748 in	0.543 in	1.969 in	0.400 in	0.13 lb
80340	099575803406	Carded	17 mm	0.748 in	0.598 in	1.969 in	0.400 in	0.16 lb
80341	099575803413	Carded	18 mm	0.748 in	0.646 in	1.969 in	0.400 in	0.16 lb
80342	099575803420	Carded	19 mm	0.748 in	0.677 in	1.969 in	0.450 in	0.16 lb

GEARWRENCH® 3/8" Drive SAE Ratcheting Crowfoot Wrenches

- Quickly Ratchet Nuts and Bolts Without Removing the Wrench From the Fastener
- Exceeds ASME Requirements for Torque Performance
- Size Laser Etched on Both Sides of Head for Easy Identification
- Bright Chrome Finish



SAE

Cat. No.	UPC No.	Packaging	Fastener Size	End A Width	End A Thickness	End A Length	Product Weight
89120	099575891205	Carded	3/8 in	0.909 in	0.224 in	1.378 in	0.04 lb
89121	099575891212	Carded	7/16 in	0.988 in	0.252 in	1.417 in	0.05 lb
89122	099575891229	Carded	1/2 in	1.134 in	0.319 in	1.575 in	0.09 lb
89123	099575891236	Carded	9/16 in	1.244 in	0.327 in	1.654 in	0.10 lb
89124	099575891243	Carded	5/8 in	1.350 in	0.346 in	1.772 in	0.12 lb
89125	099575891250	Carded	11/16 in	1.476 in	0.362 in	1.890 in	0.14 lb
89126	099575891267	Carded	3/4 in	1.602 in	0.374 in	2.047 in	0.19 lb
89127	099575891274	Carded	13/16 in	1.803 in	0.425 in	2.205 in	0.24 lb
89128	099575891281	Carded	7/8 in	1.866 in	0.449 in	2.283 in	0.29 lb
89129	099575891298	Carded	15/16 in	1.992 in	0.465 in	2.362 in	0.32 lb
89130	099575891304	Carded	1 in	2.087 in	0.476 in	2.441 in	0.32 lb

GEARWRENCH® 3/8" Drive Metric Ratcheting Crowfoot Wrenches

- Quickly Ratchet Nuts and Bolts Without Removing the Wrench From the Fastener
- Exceeds ASME Requirements for Torque Performance
- Size Laser Etched on Both Sides of Head for Easy Identification
- Bright Chrome Finish



mm

Cat. No.	UPC No.	Packaging	Fastener Size	End A Width	End A Thickness	End A Length	Product Weight
89140	099575891403	Carded	10 mm	0.909 in	0.224 in	1.378 in	0.04 lb
89141	099575891410	Carded	11 mm	0.988 in	0.252 in	1.417 in	0.05 lb
89142	099575891427	Carded	12 mm	1.094 in	0.291 in	1.496 in	0.09 lb
89143	099575891434	Carded	13 mm	1.134 in	0.319 in	1.575 in	0.10 lb
89144	099575891441	Carded	14 mm	1.244 in	0.327 in	1.654 in	0.12 lb
89145	099575891458	Carded	15 mm	1.331 in	0.327 in	1.693 in	0.14 lb
89146	099575891465	Carded	16 mm	1.350 in	0.346 in	1.772 in	0.19 lb
89147	099575891472	Carded	17 mm	1.476 in	0.362 in	1.890 in	0.24 lb
89148	099575891489	Carded	18 mm	1.539 in	0.370 in	1.969 in	0.29 lb
89149	099575891496	Carded	19 mm	1.602 in	0.374 in	2.047 in	0.32 lb

GEARWRENCH® 3/8" Drive Metric Crowfoot Wrenches

■ Premium Alloy CV Steel



Cat. No.	UPC No.	Packaging	Fastener Size	End A Width	End A Thickness	End B Width	Overall Length	Product Weight
81614	099575816147	Carded	10 mm	0.906 in	0.118 in	0.709 in	1.300 in	0.09 lb
81615	099575816154	Carded	11 mm	0.906 in	0.118 in	0.709 in	1.380 in	0.09 lb
81616	099575816161	Carded	12 mm	0.906 in	0.118 in	0.709 in	1.378 in	0.09 lb
81617	099575816178	Carded	13 mm	1.024 in	0.118 in	0.709 in	1.417 in	0.09 lb
81618	099575816185	Carded	14 mm	1.100 in	0.118 in	0.709 in	1.570 in	0.09 lb
81619	099575816192	Carded	15 mm	1.260 in	0.236 in	0.709 in	1.654 in	0.12 lb
81620	099575816208	Carded	16 mm	1.260 in	0.236 in	0.709 in	1.654 in	0.12 lb
81621	099575816215	Carded	17 mm	1.378 in	0.276 in	0.709 in	1.772 in	0.12 lb
81622	099575816222	Carded	18 mm	1.378 in	0.276 in	0.709 in	1.772 in	0.13 lb
81623	099575816239	Carded	19 mm	1.575 in	0.276 in	0.748 in	1.969 in	0.16 lb

GEARWRENCH® 3/8" Drive SAE Crowfoot Wrenches

■ Premium Alloy CV Steel



Cat. No.	UPC No.	Packaging	Fastener Size	End A Width	End A Thickness	End B Width	Overall Length	Product Weight
81603	099575816031	Carded	3/8 in	0.866 in	0.118 in	0.709 in	1.299 in	0.09 lb
81604	099575816048	Carded	7/16 in	0.945 in	0.118 in	0.709 in	1.378 in	0.09 lb
81605	099575816055	Carded	1/2 in	1.024 in	0.157 in	0.709 in	1.417 in	0.09 lb
81606	099575816062	Carded	9/16 in	1.142 in	0.157 in	0.709 in	1.535 in	0.09 lb
81607	099575816079	Carded	5/8 in	1.260 in	0.236 in	0.709 in	1.614 in	0.13 lb
81608	099575816086	Carded	11/16 in	1.378 in	0.236 in	0.709 in	1.772 in	0.13 lb
81609	099575816093	Carded	3/4 in	1.575 in	0.236 in	0.866 in	1.890 in	0.15 lb
81610	099575816109	Carded	13/16 in	1.732 in	0.276 in	1.023 in	2.047 in	0.22 lb
81611D	099575816116	Carded	7/8 in	1.819 in	0.315 in	1.023 in	2.204 in	0.22 lb
81612D	099575816123	Carded	15/16 in	2.046 in	0.354 in	1.180 in	2.361 in	0.29 lb
81613	099575816130	Carded	1 in	2.203 in	0.393 in	1.337 in	2.518 in	0.29 lb

GEARWRENCH® 3/8" Drive SAE/Metric Hex Bit Sockets

- Heat Treated Socket Bases for Durability and Serviceability
- Professional, Full Polish Chrome

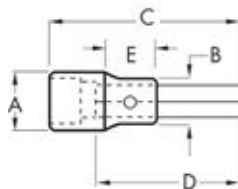

Cat. No.	UPC No.	Packaging	Fastener Size	Dim. A: Drive End	Dim. B: Nose Diameter	Dim. C: Overall Length	Dim. D: Bit Length	Exposed Bit Length	Product Weight
80410	099575804106	Carded	1/16 in	0.688 in	0.590 in	1.653 in	0.984 in	0.591	0.09 lb
80411	099575804113	Carded	5/64 in	0.688 in	0.590 in	1.653 in	0.984 in	0.591	0.11 lb
80412D	099575804120	Carded	3/32 in	0.688 in	0.590 in	1.653 in	0.984 in	0.591	0.13 lb
80413	099575804137	Carded	7/64 in	0.688 in	0.590 in	1.653 in	0.984 in	0.591	0.13 lb
80414	099575804144	Carded	1/8 in	0.688 in	0.590 in	1.653 in	0.984 in	0.591	0.13 lb
80415D	099575804151	Carded	9/64 in	0.688 in	0.590 in	1.653 in	0.984 in	0.591	0.14 lb
80416	099575804168	Carded	5/32 in	0.688 in	0.590 in	1.653 in	0.984 in	0.591	0.14 lb
80417	099575804175	Carded	3/16 in	0.688 in	0.590 in	1.653 in	0.984 in	0.591	0.14 lb
80418	099575804182	Carded	7/32 in	0.688 in	0.590 in	1.653 in	0.984 in	0.591	0.14 lb
80419	099575804199	Carded	1/4 in	0.688 in	0.590 in	1.653 in	0.984 in	0.591	0.14 lb
80420	099575810206	Carded	5/16 in	0.688 in	0.590 in	1.850 in	1.181 in	0.788	0.14 lb
80421	099575804212	Carded	3/8 in	0.750 in	0.750 in	1.850 in	1.181 in	0.788	0.14 lb
80422	099575804229	Carded	2 mm	0.688 in	0.590 in	1.653 in	0.984 in	0.625	0.15 lb
80423	099575804236	Carded	2.5 mm	0.688 in	0.590 in	1.653 in	0.984 in	0.625	0.09 lb
80424	099575804243	Carded	3 mm	0.688 in	0.590 in	1.653 in	0.984 in	0.625	0.11 lb
80425	099575804250	Carded	4 mm	0.688 in	0.590 in	1.653 in	0.984 in	0.625	0.13 lb
80426	099575804267	Carded	5 mm	0.688 in	0.590 in	1.653 in	0.984 in	0.625	0.13 lb
80427	099575804274	Carded	6 mm	0.688 in	0.590 in	1.653 in	0.984 in	0.625	0.13 lb
80428D	099575804281	Carded	7 mm	0.688 in	0.590 in	1.850 in	1.181 in	0.688	0.14 lb
80429	099575804298	Carded	8 mm	0.688 in	0.590 in	1.850 in	1.181 in	0.788	0.14 lb
80430	099575804304	Carded	9 mm	0.750 in	0.750 in	1.968 in	1.181 in	0.906	0.14 lb
80431	099575804311	Carded	10 mm	0.750 in	0.750 in	1.968 in	1.181 in	0.906	0.14 lb
80432	099575804328	Carded	11 mm	0.750 in	0.750 in	1.968 in	1.181 in	0.906	0.14 lb
80433	099575804335	Carded	12 mm	0.750 in	0.750 in	1.968 in	1.181 in	0.906	0.14 lb

3 / 8 "

3

RATCHETS / SOCKETS / DRIVE TOOLS / SETS

GEARWRENCH® 3/8" Drive SAE/Metric Ball End Hex Bit Sockets

- Heat Treated Socket Bases for Durability and Serviceability
- Professional, Full Polish Chrome

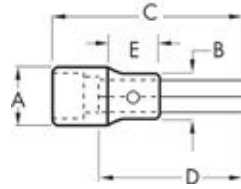

Cat. No.	UPC No.	Packaging	Fastener Size	Dim. A: Drive End	Dim. B: Nose Diameter	Dim. C: Overall Length	Dim. D: Bit Length	Exposed Bit Length	Product Weight
80539	099575805394	Carded	1/8 in	0.688 in	0.590 in	1.653 in	0.984 in	0.591	0.09 lb
80540	099575805400	Carded	5/32 in	0.688 in	0.590 in	1.653 in	0.984 in	0.591	0.10 lb
80541	099575805417	Carded	3/16 in	0.688 in	0.590 in	1.653 in	0.984 in	0.591	0.12 lb
80542	099575805424	Carded	7/32 in	0.688 in	0.590 in	1.653 in	0.984 in	0.591	0.12 lb
80543	099575805431	Carded	1/4 in	0.688 in	0.590 in	1.653 in	0.984 in	0.591	0.13 lb
80544	099575805448	Carded	5/16 in	0.688 in	0.590 in	1.653 in	1.181 in	0.591	0.14 lb
80545	099575805455	Carded	3/8 in	0.750 in	0.750 in	1.968 in	1.181 in	0.906	0.15 lb
82500	099575825002	Carded	4 mm	0.688 in	0.590 in	1.654 in	0.984 in	0.591	0.09 lb
82501	099575825019	Carded	5 mm	0.688 in	0.590 in	1.654 in	0.984 in	0.591	0.10 lb
82502	099575825026	Carded	6 mm	0.688 in	0.590 in	1.654 in	0.984 in	0.591	0.12 lb
82503	099575825033	Carded	7 mm	0.688 in	0.590 in	1.850 in	1.181 in	0.787	0.12 lb
82504	099575825040	Carded	8 mm	0.688 in	0.590 in	1.850 in	1.181 in	0.787	0.13 lb
82505	099575825057	Carded	9 mm	0.750 in	0.750 in	1.968 in	1.181 in	0.906	0.14 lb
82506	099575825064	Carded	10 mm	0.750 in	0.750 in	1.968 in	1.181 in	0.906	0.15 lb

GEARWRENCH® 3/8" Drive SAE/Metric Long Ball End Hex Bit Sockets

- Heat Treated Socket Bases for Durability and Serviceability
- Professional, Full Polish Chrome

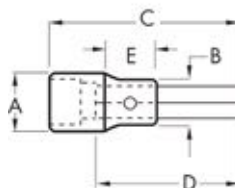

Cat. No.	UPC No.	Packaging	Fastener Size	Dim. A: Drive End	Dim. B: Nose Diameter	Dim. C: Overall Length	Dim. D: Bit Length	Exposed Bit Length	Product Weight
80434	099575804342	Carded	1/8 in	0.688 in	0.590 in	5.984 in	5.196 in	4.922	0.13 lb
80435	099575804359	Carded	5/32 in	0.688 in	0.590 in	5.984 in	5.196 in	4.922	0.14 lb
80436D	099575804366	Carded	3/16 in	0.688 in	0.590 in	5.984 in	5.196 in	4.922	0.14 lb
80437	099575804373	Carded	7/32 in	0.688 in	0.590 in	5.984 in	5.275 in	4.922	0.14 lb
80438	099575804380	Carded	1/4 in	0.688 in	0.590 in	5.984 in	5.393 in	4.922	0.15 lb
80439	099575804397	Carded	5/16 in	0.688 in	0.590 in	5.984 in	5.393 in	4.922	0.16 lb
80440	099575804403	Carded	3/8 in	0.750 in	0.590 in	5.984 in	5.275 in	4.922	0.17 lb
80441	099575804410	Carded	3 mm	0.688 in	0.590 in	5.984 in	5.196 in	4.922	0.13 lb
80442	099575804427	Carded	4 mm	0.688 in	0.590 in	5.984 in	5.196 in	4.922	0.14 lb
80443	099575804434	Carded	5 mm	0.688 in	0.590 in	5.984 in	5.196 in	4.922	0.14 lb
80444	099575804441	Carded	6 mm	0.688 in	0.590 in	5.984 in	5.314 in	4.922	0.14 lb
80445	099575804458	Carded	7 mm	0.688 in	0.590 in	5.984 in	5.393 in	4.922	0.15 lb
80446	099575804465	Carded	8 mm	0.688 in	0.590 in	5.984 in	5.393 in	4.922	0.16 lb
80447	099575804472	Carded	9 mm	0.750 in	0.750 in	5.984 in	5.275 in	4.922	0.17 lb
80448	099575804489	Carded	10 mm	0.750 in	0.750 in	5.984 in	5.275 in	4.922	0.18 lb

GEARWRENCH® 3/8" Drive Metric Triple Square Bit Sockets

- Heat Treated Socket Bases for Durability and Serviceability
- Professional, Full Polish Chrome

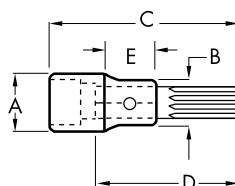

Cat. No.	UPC No.	Packaging	Fastener Size	Dim. A: Drive End	Dim. B: Nose Diameter	Dim. C: Overall Length	Dim. D: Bit Length	Exposed Bit Length	Product Weight
80449	099575804496	Carded	6 mm	0.690 in	0.313 in	3.15 in	2.48 in	2.088	0.15 lb
80450	099575804502	Carded	8 mm	0.690 in	0.313 in	3.66 in	3.66 in	2.598	0.15 lb

GEARWRENCH® 3/8" Drive Torx® Bit Sockets

- Heat Treated Socket Bases for Durability and Serviceability
- Professional, Full Polish Chrome

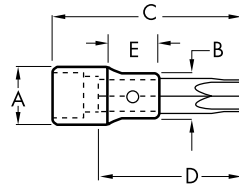

Cat. No.	UPC No.	Packaging	Fastener Size	Dim. A: Drive End	Dim. B: Nose Diameter	Dim. C: Overall Length	Dim. D: Bit Length	Exposed Bit Length	Product Weight
80534	099575805349	Carded	T15	0.688 in	0.590 in	1.181 in	0.984 in	0.119	0.12 lb
80535	099575805356	Carded	T20	0.688 in	0.590 in	1.181 in	0.984 in	0.119	0.12 lb
80536	099575805363	Carded	T25	0.688 in	0.590 in	1.181 in	0.984 in	0.119	0.14 lb
80537	099575805370	Carded	T27	0.688 in	0.590 in	1.181 in	0.984 in	0.119	0.15 lb
80538	099575805387	Carded	T30	0.688 in	0.590 in	1.181 in	0.984 in	0.119	0.15 lb
80451	099575804519	Carded	T40	0.688 in	0.590 in	1.850 in	1.181 in	0.788	0.18 lb
80452	099575804526	Carded	T45	0.688 in	0.590 in	1.850 in	1.181 in	0.788	0.18 lb
80453	099575804533	Carded	T47	0.688 in	0.590 in	1.850 in	1.181 in	0.788	0.18 lb
80454	099575804540	Carded	T50	0.688 in	0.590 in	1.850 in	1.181 in	0.788	0.20 lb
80455	099575804557	Carded	T55	0.688 in	0.590 in	1.850 in	1.181 in	0.788	0.20 lb

GEARWRENCH® 3/8" Drive Torx® Tamper Proof Bit Sockets

- Heat Treated Socket Bases for Durability and Serviceability
- Professional, Full Polish Chrome

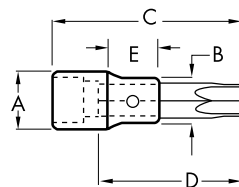

Cat. No.	UPC No.	Packaging	Fastener Size	Dim. A: Drive End	Dim. B: Nose Diameter	Dim. C: Overall Length	Dim. D: Bit Length	Exposed Bit Length	Product Weight
80456D	099575804564	Carded	T40	0.688 in	0.590 in	1.850 in	1.181 in	0.788	0.35 lb
80457	099575804571	Carded	T45	0.688 in	0.590 in	1.850 in	1.181 in	0.788	0.39 lb
80458	099575804588	Carded	T50	0.688 in	0.590 in	1.850 in	1.181 in	0.788	0.45 lb
80459	099575804595	Carded	T55	0.750 in	0.750 in	1.850 in	1.181 in	0.788	0.45 lb

GEARWRENCH® 3/8" Drive Torx® Long Bit Sockets

- Heat Treated Socket Bases for Durability and Serviceability
- Professional, Full Polish Chrome

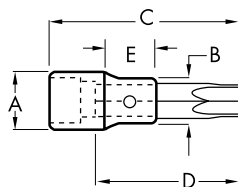

Cat. No.	UPC No.	Packaging	Fastener Size	Dim. A: Drive End	Dim. B: Nose Diameter	Dim. C: Overall Length	Dim. D: Bolt Clearance	Exposed Bit Length	Product Weight
82517	099575825170	Carded	T40	0.688 in	0.590 in	5.984 in	5.196 in	4.922	0.45 lb
82518	099575825187	Carded	T45	0.688 in	0.590 in	5.984 in	5.196 in	4.922	0.48 lb
82519	099575825194	Carded	T50	0.688 in	0.590 in	5.984 in	5.196 in	4.922	0.52 lb

GEARWRENCH® 3/8" Drive External Torx® Sockets

- Black Oxide Finish

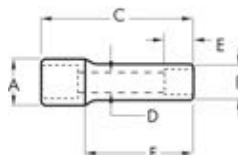

Cat. No.	UPC No.	Packaging	Fastener Size	Dim. A: Drive End	Dim. B: Nose Diameter	Dim. C: Overall Length	Dim. D: Bolt Clearance	Product Weight
80460	099575804601	Carded	E10	0.750 in	0.750 in	1.240 in	0.196 in	0.12 lb
80461	099575804618	Carded	E12	0.750 in	0.750 in	1.240 in	0.314 in	0.14 lb
80462	099575804625	Carded	E14	0.750 in	0.750 in	1.240 in	0.314 in	0.16 lb
80463	099575804632	Carded	E16	0.750 in	0.750 in	1.240 in	0.314 in	0.18 lb

GEARWRENCH® 3/8" Drive Bit Adapter

- Professional, Full Polish Chrome
- Use 80481 5/16" Bit Holder Socket with 80477, 80478 and 80479 Tamper Proof Torx® Bit



Cat. No.	UPC No.	Packaging	Dim. A: Drive End	Dim. B: Nose Diameter	Dim. C: Overall Length	Replacement Bit	Product Weight
80481	099575804816	Carded	0.750 in	0.750 in	1.240 in	Yes	0.12 lb

3 / 8 "

3

RATCHETS / SOCKETS / DRIVE TOOLS / SETS

GEARWRENCH® 3/8" Drive Tamper-Proof Torx® Exchangeable Bits

■ Use 80481 5/16" Bit Holder Socket with 80477, 80478, and 80479D Tamper Proof Torx® Bits



Cat. No.	UPC No.	Packaging	Fastener Size	Dim. A: Drive End	Dim. B: Nose Diameter	Dim. C: Overall Length	Dim. D: Bit Length	Replacement Bit	Product Weight
80477	099575804779	Carded	T40	0.688 in	0.590 in	1.181 in	1.181 in	No	0.15 lb
80478	099575804786	Carded	T45	0.688 in	0.590 in	1.181 in	1.181 in	No	0.17 lb
80479D	099575804793	Carded	T50	0.688 in	0.590 in	1.181 in	1.181 in	No	0.19 lb

GEARWRENCH® 3/8" Drive Slotted/Phillips/Pozidriv® Bit Sockets

■ Heat Treated Socket Bases for Durability and Serviceability
 ■ Professional, Full Polish Chrome

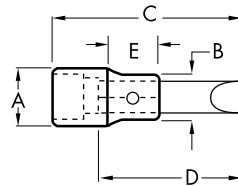

Cat. No.	UPC No.	Packaging	Drive Type	Fastener Size	Dim. A: Drive End	Dim. B: Nose Diameter	Dim. C: Overall Length	Dim. D: Bit Length	Exposed Bit Length	Product Weight
80464	099575804649	Carded	Slotted	4 mm	0.688 in	0.590 in	1.653 in	0.984 in	0.591	0.09 lb
80465	099575804656	Carded	Slotted	5 mm	0.688 in	0.590 in	1.653 in	0.984 in	0.591	0.10 lb
80466	099575804663	Carded	Slotted	6 mm	0.688 in	0.590 in	1.653 in	0.984 in	0.591	0.10 lb
80467	099575804670	Carded	Phillips®	#1	0.688 in	0.590 in	1.653 in	0.984 in	0.591	0.09 lb
80468	099575804687	Carded	Phillips®	#2	0.688 in	0.590 in	1.653 in	0.984 in	0.591	0.09 lb
80469	099575804694	Carded	Phillips®	#3	0.688 in	0.590 in	1.653 in	0.984 in	0.591	0.10 lb
80470	099575804700	Carded	Slotted/Phillips®/ Pozidriv®	#2	0.688 in	0.590 in	1.653 in	0.984 in	0.591	0.09 lb

GEARWRENCH® 49 Pc. 1/2" Drive 6 Point SAE/Metric Standard and Deep Mechanics Tool Set

- Includes Storage Case
- Full Polish Chrome Sockets With Large Hard Stamp Size Markings
- 84 Tooth Full Polish Chrome Thin Profile Ratchet
- Knurled Full Polish Chrome Extensions
- Sockets Feature Surface Drive® Technology To Reduce Fastener Rounding
- Meets or Exceeds ASME B107.1, B107.5M, B107.10



Cat. No.	UPC No.	Packaging	Product Weight
80700D	099575807008	Boxed	9.09 lb

Cat. No.	Description	Cat. No.	Description
81304F	1/2" Drive Full Polish Teardrop Ratchet	80624	1/2" Drive 6 Point Standard Metric Socket 12mm
81340	1/2" Drive Standard Extension 3"	80625	1/2" Drive 6 Point Standard Metric Socket 13mm
81341	1/2" Drive Standard Extension 5"	80626D	1/2" Drive 6 Point Standard Metric Socket 14mm
80602	1/2" Drive 6 Point Standard SAE Socket 7/16"	80627	1/2" Drive 6 Point Standard Metric Socket 15mm
80603	1/2" Drive 6 Point Standard SAE Socket 1/2"	80628	1/2" Drive 6 Point Standard Metric Socket 16mm
80604	1/2" Drive 6 Point Standard SAE Socket 9/16"	80629	1/2" Drive 6 Point Standard Metric Socket 17mm
80605	1/2" Drive 6 Point Standard SAE Socket 5/8"	80630	1/2" Drive 6 Point Standard Metric Socket 18mm
80606	1/2" Drive 6 Point Standard SAE Socket 11/16"	80631	1/2" Drive 6 Point Standard Metric Socket 19mm
80607D	1/2" Drive 6 Point Standard SAE Socket 3/4"	80632	1/2" Drive 6 Point Standard Metric Socket 20mm
80608	1/2" Drive 6 Point Standard SAE Socket 13/16"	80633	1/2" Drive 6 Point Standard Metric Socket 21mm
80609	1/2" Drive 6 Point Standard SAE Socket 7/8"	80634	1/2" Drive 6 Point Standard Metric Socket 22mm
80610D	1/2" Drive 6 Point Standard SAE Socket 15/16"	80635	1/2" Drive 6 Point Standard Metric Socket 23mm
80611	1/2" Drive 6 Point Standard SAE Socket 1"	80636D	1/2" Drive 6 Point Standard Metric Socket 24mm
80612	1/2" Drive 6 Point Standard SAE Socket 1-1/16"	80637	1/2" Drive 6 Point Deep Metric Socket 10mm
80613	1/2" Drive 6 Point Standard SAE Socket 1-1/8"	80638	1/2" Drive 6 Point Deep Metric Socket 11mm
80614	1/2" Drive 6 Point Deep SAE Socket 1/2"	80639	1/2" Drive 6 Point Deep Metric Socket 12mm
80615	1/2" Drive 6 Point Deep SAE Socket 9/16"	80640	1/2" Drive 6 Point Deep Metric Socket 13mm
80616	1/2" Drive 6 Point Deep SAE Socket 5/8"	80641	1/2" Drive 6 Point Deep Metric Socket 14mm
80617	1/2" Drive 6 Point Deep SAE Socket 11/16"	80642	1/2" Drive 6 Point Deep Metric Socket 15mm
80618	1/2" Drive 6 Point Deep SAE Socket 3/4"	80643	1/2" Drive 6 Point Deep Metric Socket 16mm
80619	1/2" Drive 6 Point Deep SAE Socket 13/16"	80644	1/2" Drive 6 Point Deep Metric Socket 17mm
80620	1/2" Drive 6 Point Deep SAE Socket 7/8"	80645	1/2" Drive 6 Point Deep Metric Socket 18mm
80621	1/2" Drive 6 Point Deep SAE Socket 15/16"	80646D	1/2" Drive 6 Point Deep Metric Socket 19mm
80622	1/2" Drive 6 Point Standard Metric Socket 10mm	80600D	1/2" Drive Universal Joint
80623	1/2" Drive 6 Point Standard Metric Socket 11mm		

1 / 2 "

3

RATCHETS / SOCKETS / DRIVE TOOLS / SETS

GEARWRENCH® 49 Pc. 1/2" Drive 12 Point SAE/Metric Standard and Deep Mechanics Tool Set

- Includes Storage Case
- Full Polish Chrome Sockets With Large Hard Stamp Size Markings
- 84 Tooth Full Polish Chrome Thin Profile Ratchet
- Knurled Full Polish Chrome Extensions
- Sockets Feature Surface Drive® Technology To Reduce Fastener Rounding
- Meets or Exceeds ASME B107.1, B107.5M, B107.10



Cat. No.	UPC No.	Packaging	Product Weight
80701	099575807015	Boxed	9.09 lb

Cat. No.	Description	Cat. No.	Description
81304F	1/2" Drive Full Polish Teardrop Ratchet	80747	1/2" Drive 12 Point Standard Metric Socket 12mm
81340	1/2" Drive Standard Extension 3"	80748D	1/2" Drive 12 Point Standard Metric Socket 13mm
81341	1/2" Drive Standard Extension 5"	80749	1/2" Drive 12 Point Standard Metric Socket 14mm
80760	1/2" Drive 12 Point Standard SAE Socket 7/16"	80750	1/2" Drive 12 Point Standard Metric Socket 15mm
80761	1/2" Drive 12 Point Standard SAE Socket 1/2"	80751	1/2" Drive 12 Point Standard Metric Socket 16mm
80762	1/2" Drive 12 Point Standard SAE Socket 9/16"	80752	1/2" Drive 12 Point Standard Metric Socket 17mm
80763	1/2" Drive 12 Point Standard SAE Socket 5/8"	80753	1/2" Drive 12 Point Standard Metric Socket 18mm
80764	1/2" Drive 12 Point Standard SAE Socket 11/16"	80754	1/2" Drive 12 Point Standard Metric Socket 19mm
80765	1/2" Drive 12 Point Standard SAE Socket 3/4"	80755D	1/2" Drive 12 Point Standard Metric Socket 20mm
80766	1/2" Drive 12 Point Standard SAE Socket 13/16"	80756	1/2" Drive 12 Point Standard Metric Socket 21mm
80767	1/2" Drive 12 Point Standard SAE Socket 7/8"	80757	1/2" Drive 12 Point Standard Metric Socket 22mm
80768	1/2" Drive 12 Point Standard SAE Socket 15/16"	80758	1/2" Drive 12 Point Standard Metric Socket 23mm
80769	1/2" Drive 12 Point Standard SAE Socket 1"	80759	1/2" Drive 12 Point Standard Metric Socket 24mm
80770	1/2" Drive 12 Point Standard SAE Socket 1-1/16"	80781	1/2" Drive 12 Point Deep Metric Socket 10mm
80771	1/2" Drive 12 Point Standard SAE Socket 1-1/8"	80782	1/2" Drive 12 Point Deep Metric Socket 11mm
80773	1/2" Drive 12 Point Deep SAE Socket 1/2"	80783	1/2" Drive 12 Point Deep Metric Socket 12mm
80774	1/2" Drive 12 Point Deep SAE Socket 9/16"	80784	1/2" Drive 12 Point Deep Metric Socket 13mm
80775	1/2" Drive 12 Point Deep SAE Socket 5/8"	80785	1/2" Drive 12 Point Deep Metric Socket 14mm
80776	1/2" Drive 12 Point Deep SAE Socket 11/16"	80786	1/2" Drive 12 Point Deep Metric Socket 15mm
80777D	1/2" Drive 12 Point Deep SAE Socket 3/4"	80787	1/2" Drive 12 Point Deep Metric Socket 16mm
80778	1/2" Drive 12 Point Deep SAE Socket 13/16"	80788	1/2" Drive 12 Point Deep Metric Socket 17mm
80779	1/2" Drive 12 Point Deep SAE Socket 7/8"	80789	1/2" Drive 12 Point Deep Metric Socket 18mm
80780	1/2" Drive 12 Point Deep SAE Socket 15/16"	80790	1/2" Drive 12 Point Deep Metric Socket 19mm
80745	1/2" Drive 12 Point Standard Metric Socket 10mm	80600D	1/2" Drive Universal Joint
80746	1/2" Drive 12 Point Standard Metric Socket 11mm		

GEARWRENCH® 49 Pc. 1/2" Drive 6 Point SAE/Metric Standard and Deep Mechanics Tool Set

120XP

- 120 Position, 3° ratcheting arc ratchet with teardrop low profile head and flush mounted on/off switch for improved access
- Full Polish Chrome Sockets With Large Hard Stamp Size Markings
- Knurled Full Polish Extensions
- Sockets Feature Surface Drive® Technology To Reduce Fastener Rounding
- Meets or Exceeds ASME B107.1, B107.5M, B107.10
- Includes storage case



Cat. No.	UPC No.	Product Weight
80700P	099575810701	10.05 lb

Cat. No.	Description	Cat. No.	Description
81304P	1/2" Drive 120XP Full Polish Teardrop Ratchet	80624	1/2" Drive 6 Point Standard Metric Socket 12mm
81340	1/2" Drive Standard Extension 3"	80625	1/2" Drive 6 Point Standard Metric Socket 13mm
81341	1/2" Drive Standard Extension 5"	80626D	1/2" Drive 6 Point Standard Metric Socket 14mm
80602	1/2" Drive 6 Point Standard SAE Socket 7/16"	80627	1/2" Drive 6 Point Standard Metric Socket 15mm
80603	1/2" Drive 6 Point Standard SAE Socket 1/2"	80628	1/2" Drive 6 Point Standard Metric Socket 16mm
80604	1/2" Drive 6 Point Standard SAE Socket 9/16"	80629	1/2" Drive 6 Point Standard Metric Socket 17mm
80605	1/2" Drive 6 Point Standard SAE Socket 5/8"	80630	1/2" Drive 6 Point Standard Metric Socket 18mm
80606	1/2" Drive 6 Point Standard SAE Socket 11/16"	80631	1/2" Drive 6 Point Standard Metric Socket 19mm
80607D	1/2" Drive 6 Point Standard SAE Socket 3/4"	80632	1/2" Drive 6 Point Standard Metric Socket 20mm
80608	1/2" Drive 6 Point Standard SAE Socket 13/16"	80633	1/2" Drive 6 Point Standard Metric Socket 21mm
80609	1/2" Drive 6 Point Standard SAE Socket 7/8"	80634	1/2" Drive 6 Point Standard Metric Socket 22mm
80610D	1/2" Drive 6 Point Standard SAE Socket 15/16"	80635	1/2" Drive 6 Point Standard Metric Socket 23mm
80611	1/2" Drive 6 Point Standard SAE Socket 1"	80636D	1/2" Drive 6 Point Standard Metric Socket 24mm
80612	1/2" Drive 6 Point Standard SAE Socket 1-1/16"	80637	1/2" Drive 6 Point Deep Metric Socket 10mm
80613	1/2" Drive 6 Point Standard SAE Socket 1-1/8"	80638	1/2" Drive 6 Point Deep Metric Socket 11mm
80614	1/2" Drive 6 Point Deep SAE Socket 1/2"	80639	1/2" Drive 6 Point Deep Metric Socket 12mm
80615	1/2" Drive 6 Point Deep SAE Socket 9/16"	80640	1/2" Drive 6 Point Deep Metric Socket 13mm
80616	1/2" Drive 6 Point Deep SAE Socket 5/8"	80641	1/2" Drive 6 Point Deep Metric Socket 14mm
80617	1/2" Drive 6 Point Deep SAE Socket 11/16"	80642	1/2" Drive 6 Point Deep Metric Socket 15mm
80618	1/2" Drive 6 Point Deep SAE Socket 3/4"	80643	1/2" Drive 6 Point Deep Metric Socket 16mm
80619	1/2" Drive 6 Point Deep SAE Socket 13/16"	80644	1/2" Drive 6 Point Deep Metric Socket 17mm
80620	1/2" Drive 6 Point Deep SAE Socket 7/8"	80645	1/2" Drive 6 Point Deep Metric Socket 18mm
80621	1/2" Drive 6 Point Deep SAE Socket 15/16"	80646D	1/2" Drive 6 Point Deep Metric Socket 19mm
80622	1/2" Drive 6 Point Standard Metric Socket 10mm	80600D	1/2" Drive Universal Joint
80623	1/2" Drive 6 Point Standard Metric Socket 11mm		

1 / 2 "

3

RATCHETS / SOCKETS / DRIVE TOOLS / SETS

GEARWRENCH® 33 Pc. 1/2" Drive 6 Point SAE Standard and Deep Mechanics Tool Set

- Includes Storage Case
- Full Polish Chrome Sockets With Large Hard Stamp Size Markings
- 84 Tooth Full Polish Chrome Thin Profile Ratchet
- Knurled Full Polish Chrome Extensions
- Sockets Feature Surface Drive® Technology To Reduce Fastener Rounding
- Meets or Exceeds ASME B107.1, B107.10



Cat. No.	UPC No.	Packaging	Product Weight
80715	099575807152	Boxed	8.55 lb

Cat. No.	Description	Cat. No.	Description
81304F	1/2" Drive Full Polish Teardrop Ratchet	80679	1/2" Drive 6 Point Standard SAE Socket 1-1/2"
81307	1/2" Drive Full Polish Flex Handle 15"	80684	1/2" Drive 6 Point Deep SAE Socket 7/16"
81340	1/2" Drive Standard Extension 3"	80614	1/2" Drive 6 Point Deep SAE Socket 1/2"
81341	1/2" Drive Standard Extension 5"	80615	1/2" Drive 6 Point Deep SAE Socket 9/16"
80602	1/2" Drive 6 Point Standard SAE Socket 7/16"	80616	1/2" Drive 6 Point Deep SAE Socket 5/8"
80603	1/2" Drive 6 Point Standard SAE Socket 1/2"	80617	1/2" Drive 6 Point Deep SAE Socket 11/16"
80604	1/2" Drive 6 Point Standard SAE Socket 9/16"	80618	1/2" Drive 6 Point Deep SAE Socket 3/4"
80605	1/2" Drive 6 Point Standard SAE Socket 5/8"	80619	1/2" Drive 6 Point Deep SAE Socket 13/16"
80606	1/2" Drive 6 Point Standard SAE Socket 11/16"	80620	1/2" Drive 6 Point Deep SAE Socket 7/8"
80607D	1/2" Drive 6 Point Standard SAE Socket 3/4"	80621	1/2" Drive 6 Point Deep SAE Socket 15/16"
80608	1/2" Drive 6 Point Standard SAE Socket 13/16"	80674	1/2" Drive 6 Point Deep SAE Socket 1"
80609	1/2" Drive 6 Point Standard SAE Socket 7/8"	80675	1/2" Drive 6 Point Deep SAE Socket 1-1/16"
80610D	1/2" Drive 6 Point Standard SAE Socket 15/16"	80676	1/2" Drive 6 Point Deep SAE Socket 1-1/8"
80611	1/2" Drive 6 Point Standard SAE Socket 1"	80685	1/2" Drive 6 Point Deep SAE Socket 1-1/4"
80612	1/2" Drive 6 Point Standard SAE Socket 1-1/16"	80686	1/2" Drive 6 Point Deep SAE Socket 1-1/2"
80613	1/2" Drive 6 Point Standard SAE Socket 1-1/8"	80600D	1/2" Drive Universal Joint
80678	1/2" Drive 6 Point Standard SAE Socket 1-1/4"		

GEARWRENCH® 33 Pc. 1/2" Drive 12 Point SAE Standard and Deep Mechanics Tool Set

- Includes Storage Case
- Full Polish Chrome Sockets With Large Hard Stamp Size Markings
- 84 Tooth Full Polish Chrome Thin Profile Ratchet
- Knurled Full Polish Chrome Extensions
- Sockets Feature Surface Drive® Technology To Reduce Fastener Rounding
- Meets or Exceeds ASME B107.1, B107.10



Cat. No.	UPC No.	Packaging	Product Weight
80714D	099575807145	Boxed	6.69 lb

Cat. No.	Description	Cat. No.	Description
81304F	1/2" Drive Full Polish Teardrop Ratchet	80680	1/2" Drive 12 Point Standard SAE Socket 1-1/2"
81307	1/2" Drive Full Polish Flex Handle 15"	80772	1/2" Drive 12 Point Deep SAE Socket 7/16"
81340	1/2" Drive Standard Extension 3"	80773	1/2" Drive 12 Point Deep SAE Socket 1/2"
81341	1/2" Drive Standard Extension 5"	80774	1/2" Drive 12 Point Deep SAE Socket 9/16"
80760	1/2" Drive 12 Point Standard SAE Socket 7/16"	80775	1/2" Drive 12 Point Deep SAE Socket 5/8"
80761	1/2" Drive 12 Point Standard SAE Socket 1/2"	80776	1/2" Drive 12 Point Deep SAE Socket 11/16"
80762	1/2" Drive 12 Point Standard SAE Socket 9/16"	80777D	1/2" Drive 12 Point Deep SAE Socket 3/4"
80763	1/2" Drive 12 Point Standard SAE Socket 5/8"	80778	1/2" Drive 12 Point Deep SAE Socket 13/16"
80764	1/2" Drive 12 Point Standard SAE Socket 11/16"	80779	1/2" Drive 12 Point Deep SAE Socket 7/8"
80765	1/2" Drive 12 Point Standard SAE Socket 3/4"	80780	1/2" Drive 12 Point Deep SAE Socket 15/16"
80766	1/2" Drive 12 Point Standard SAE Socket 13/16"	80795	1/2" Drive 12 Point Deep SAE Socket 1"
80767	1/2" Drive 12 Point Standard SAE Socket 7/8"	80796	1/2" Drive 12 Point Deep SAE Socket 1-1/16"
80768	1/2" Drive 12 Point Standard SAE Socket 15/16"	80797	1/2" Drive 12 Point Deep SAE Socket 1-1/8"
80769	1/2" Drive 12 Point Standard SAE Socket 1"	80798	1/2" Drive 12 Point Deep Socket 1-1/4"
80770	1/2" Drive 12 Point Standard SAE Socket 1-1/16"	80687	1/2" Drive 12 Point Deep SAE Socket 1-1/2"
80771	1/2" Drive 12 Point Standard SAE Socket 1-1/8"	80600D	1/2" Drive Universal Joint
80794	1/2" Drive 12 Point Standard SAE Socket 1-1/4"		

1 / 2 "

3 RATCHETS / SOCKETS / DRIVE TOOLS / SETS

GEARWRENCH® 23 Pc. 1/2" Drive 6 Point SAE Standard and Deep Mechanics Tool Set

- Includes Storage Case
- Full Polish Chrome Sockets With Large Hard Stamp Size Markings
- 84 Tooth Full Polish Chrome Thin Profile Ratchet
- Knurled Full Polish Chrome Extensions
- Sockets Feature Surface Drive® Technology To Reduce Fastener Rounding
- Meets or Exceeds ASME B107.1, B107.10



Cat. No.	UPC No.	Packaging	Product Weight
80707	099575807077	Boxed	5.50 lb

Cat. No.	Description	Cat. No.	Description
81304F	1/2" Drive Full Polish Teardrop Ratchet	80611	1/2" Drive 6 Point Standard SAE Socket 1"
81341	1/2" Drive Standard Extension 5"	80612	1/2" Drive 6 Point Standard SAE Socket 1-1/16"
81343	1/2" Drive Standard Extension 15"	80613	1/2" Drive 6 Point Standard SAE Socket 1-1/8"
80602	1/2" Drive 6 Point Standard SAE Socket 7/16"	80614	1/2" Drive 6 Point Deep SAE Socket 1/2"
80603	1/2" Drive 6 Point Standard SAE Socket 1/2"	80615	1/2" Drive 6 Point Deep SAE Socket 9/16"
80604	1/2" Drive 6 Point Standard SAE Socket 9/16"	80616	1/2" Drive 6 Point Deep SAE Socket 5/8"
80605	1/2" Drive 6 Point Standard SAE Socket 5/8"	80617	1/2" Drive 6 Point Deep SAE Socket 11/16"
80606	1/2" Drive 6 Point Standard SAE Socket 11/16"	80618	1/2" Drive 6 Point Deep SAE Socket 3/4"
80607D	1/2" Drive 6 Point Standard SAE Socket 3/4"	80619	1/2" Drive 6 Point Deep SAE Socket 13/16"
80608	1/2" Drive 6 Point Standard SAE Socket 13/16"	80620	1/2" Drive 6 Point Deep SAE Socket 7/8"
80609	1/2" Drive 6 Point Standard SAE Socket 7/8"	80621	1/2" Drive 6 Point Deep SAE Socket 15/16"
80610D	1/2" Drive 6 Point Standard SAE Socket 15/16"		

GEARWRENCH® 28 Pc. 1/2" Drive 6 and 12 Point Metric Standard and Deep Mechanics Tool Set

- Includes Storage Case
- Full Polish Chrome Sockets With Large Hard Stamp Size Markings
- 84 Tooth Full Polish Chrome Thin Profile Ratchet
- Knurled Full Polish Chrome Extensions
- Sockets Feature Surface Drive® Technology To Reduce Fastener Rounding
- Meets or Exceeds ASME B107.5M, B107.10



Cat. No.	UPC No.	Packaging	Product Weight
80709	099575807091	Boxed	6.50 lb

Cat. No.	Description	Cat. No.	Description
81304F	1/2" Drive Full Polish Teardrop Ratchet	80746	1/2" Drive 12 Point Standard Metric Socket 11mm
81341	1/2" Drive Standard Extension 5"	80747	1/2" Drive 12 Point Standard Metric Socket 12mm
81343	1/2" Drive Standard Extension 15"	80748D	1/2" Drive 12 Point Standard Metric Socket 13mm
80637	1/2" Drive 6 Point Deep Metric Socket 10mm	80749	1/2" Drive 12 Point Standard Metric Socket 14mm
80638	1/2" Drive 6 Point Deep Metric Socket 11mm	80750	1/2" Drive 12 Point Standard Metric Socket 15mm
80639	1/2" Drive 6 Point Deep Metric Socket 12mm	80751	1/2" Drive 12 Point Standard Metric Socket 16mm
80640	1/2" Drive 6 Point Deep Metric Socket 13mm	80752	1/2" Drive 12 Point Standard Metric Socket 17mm
80641	1/2" Drive 6 Point Deep Metric Socket 14mm	80753	1/2" Drive 12 Point Standard Metric Socket 18mm
80642	1/2" Drive 6 Point Deep Metric Socket 15mm	80754	1/2" Drive 12 Point Standard Metric Socket 19mm
80643	1/2" Drive 6 Point Deep Metric Socket 16mm	80755D	1/2" Drive 12 Point Standard Metric Socket 20mm
80644	1/2" Drive 6 Point Deep Metric Socket 17mm	80756	1/2" Drive 12 Point Standard Metric Socket 21mm
80645	1/2" Drive 6 Point Deep Metric Socket 18mm	80757	1/2" Drive 12 Point Standard Metric Socket 22mm
80646D	1/2" Drive 6 Point Deep Metric Socket 19mm	80758	1/2" Drive 12 Point Standard Metric Socket 23mm
80745	1/2" Drive 12 Point Standard Metric Socket 10mm	80759	1/2" Drive 12 Point Standard Metric Socket 24mm

1 / 2 "

3

RATCHETS / SOCKETS / DRIVE TOOLS / SETS

GEARWRENCH® 17 Pc. 1/2" Drive 6 Point SAE Mechanics Tool Set

- Includes Storage Case
- Full Polish Chrome Sockets With Large Hard Stamp Size Markings
- 84 Tooth Full Polish Chrome Thin Profile Ratchet
- Knurled Full Polish Chrome Extension
- Sockets Feature Surface Drive® Technology To Reduce Fastener Rounding
- Meets or Exceeds ASME B107.1, B107.10



Cat. No.	UPC No.	Packaging	Product Weight
80717	099575807176	Boxed	3.95 lb

Cat. No.	Description	Cat. No.	Description
81304F	1/2" Drive Full Polish Teardrop Ratchet	80608	1/2" Drive 6 Point Standard SAE Socket 13/16"
81307	1/2" Drive Full Polish Flex Handle 15"	80609	1/2" Drive 6 Point Standard SAE Socket 7/8"
81341	1/2" Drive Standard Extension 5"	80610D	1/2" Drive 6 Point Standard SAE Socket 15/16"
80602	1/2" Drive 6 Point Standard SAE Socket 7/16"	80611	1/2" Drive 6 Point Standard SAE Socket 1"
80603	1/2" Drive 6 Point Standard SAE Socket 1/2"	80612	1/2" Drive 6 Point Standard SAE Socket 1-1/16"
80604	1/2" Drive 6 Point Standard SAE Socket 9/16"	80613	1/2" Drive 6 Point Standard SAE Socket 1-1/8"
80605	1/2" Drive 6 Point Standard SAE Socket 5/8"	80678	1/2" Drive 6 Point Standard SAE Socket 1-1/4"
80606	1/2" Drive 6 Point Standard SAE Socket 11/16"	80679	1/2" Drive 6 Point Standard SAE Socket 1-1/2"
80607D	1/2" Drive 6 Point Standard SAE Socket 3/4"	80600D	1/2" Drive Universal Joint

GEARWRENCH® 17 Pc. 1/2" Drive 12 Point SAE Mechanics Tool Set

- Includes Storage Case
- Full Polish Chrome Sockets With Large Hard Stamp Size Markings
- 84 Tooth Full Polish Chrome Thin Profile Ratchet
- Knurled Full Polish Chrome Extension
- Sockets Feature Surface Drive® Technology To Reduce Fastener Rounding
- Meets or Exceeds ASME B107.1, B107.10



Cat. No.	UPC No.	Packaging	Product Weight
80716	099575807169	Boxed	3.95 lb

Cat. No.	Description	Cat. No.	Description
81304F	1/2" Drive Full Polish Teardrop Ratchet	80766	1/2" Drive 12 Point Standard SAE Socket 13/16"
81307	1/2" Drive Full Polish Flex Handle 15"	80767	1/2" Drive 12 Point Standard SAE Socket 7/8"
81341	1/2" Drive Standard Extension 5"	80768	1/2" Drive 12 Point Standard SAE Socket 15/16"
80760	1/2" Drive 12 Point Standard SAE Socket 7/16"	80769	1/2" Drive 12 Point Standard SAE Socket 1"
80761	1/2" Drive 12 Point Standard SAE Socket 1/2"	80770	1/2" Drive 12 Point Standard SAE Socket 1-1/16"
80762	1/2" Drive 12 Point Standard SAE Socket 9/16"	80771	1/2" Drive 12 Point Standard SAE Socket 1-1/8"
80763	1/2" Drive 12 Point Standard SAE Socket 5/8"	80794	1/2" Drive 12 Point Standard SAE Socket 1-1/4"
80764	1/2" Drive 12 Point Standard SAE Socket 11/16"	80680	1/2" Drive 12 Point Standard SAE Socket 1-1/2"
80765	1/2" Drive 12 Point Standard SAE Socket 3/4"	80600D	1/2" Drive Universal Joint

GEARWRENCH® 15 Pc. 1/2" Drive 6 Point SAE Mechanics Tool Set

- Includes Storage Case
- Full Polish Chrome Sockets With Large Hard Stamp Size Markings
- 84 Tooth Full Polish Chrome Thin Profile Ratchet
- Knurled Full Polish Chrome Extension
- Sockets Feature Surface Drive® Technology To Reduce Fastener Rounding
- Meets or Exceeds ASME B107.1, B107.10



Cat. No.	UPC No.	Packaging	Product Weight
80706	099575807060	Boxed	5.80 lb

Cat. No.	Description	Cat. No.	Description
81304F	1/2" Drive Full Polish Teardrop Ratchet	80607D	1/2" Drive 6 Point Standard SAE Socket 3/4"
81341	1/2" Drive Standard Extension 5"	80608	1/2" Drive 6 Point Standard SAE Socket 13/16"
81343	1/2" Drive Standard Extension 15"	80609	1/2" Drive 6 Point Standard SAE Socket 7/8"
80602	1/2" Drive 6 Point Standard SAE Socket 7/16"	80610D	1/2" Drive 6 Point Standard SAE Socket 15/16"
80603	1/2" Drive 6 Point Standard SAE Socket 1/2"	80611	1/2" Drive 6 Point Standard SAE Socket 1"
80604	1/2" Drive 6 Point Standard SAE Socket 9/16"	80612	1/2" Drive 6 Point Standard SAE Socket 1-1/16"
80605	1/2" Drive 6 Point Standard SAE Socket 5/8"	80613	1/2" Drive 6 Point Standard SAE Socket 1-1/8"
80606	1/2" Drive 6 Point Standard SAE Socket 11/16"		

GEARWRENCH® 18 Pc. 1/2" Drive 6 Point Metric Mechanics Tool Set

- Includes Storage Case
- Full Polish Chrome Sockets With Large Hard Stamp Size Markings
- 84 Tooth Full Polish Chrome Thin Profile Ratchet
- Knurled Full Polish Chrome Extension
- Sockets Feature Surface Drive® Technology To Reduce Fastener Rounding
- Meets or Exceeds ASME B107.5M, B107.10



Cat. No.	UPC No.	Packaging	Product Weight
80708	099575807084	Boxed	7.97 lb

Cat. No.	Description	Cat. No.	Description
81304F	1/2" Drive Full Polish Teardrop Ratchet	80628	1/2" Drive 6 Point Standard Metric Socket 16mm
81341	1/2" Drive Standard Extension 5"	80629	1/2" Drive 6 Point Standard Metric Socket 17mm
81343	1/2" Drive Standard Extension 15"	80630	1/2" Drive 6 Point Standard Metric Socket 18mm
80622	1/2" Drive 6 Point Standard Metric Socket 10mm	80631	1/2" Drive 6 Point Standard Metric Socket 19mm
80623	1/2" Drive 6 Point Standard Metric Socket 11mm	80632	1/2" Drive 6 Point Standard Metric Socket 20mm
80624	1/2" Drive 6 Point Standard Metric Socket 12mm	80633	1/2" Drive 6 Point Standard Metric Socket 21mm
80625	1/2" Drive 6 Point Standard Metric Socket 13mm	80634	1/2" Drive 6 Point Standard Metric Socket 22mm
80626D	1/2" Drive 6 Point Standard Metric Socket 14mm	80635	1/2" Drive 6 Point Standard Metric Socket 23mm
80627	1/2" Drive 6 Point Standard Metric Socket 15mm	80636D	1/2" Drive 6 Point Standard Metric Socket 24mm

1 / 2 " 3 RATCHETS / SOCKETS / DRIVE TOOLS / SETS

GEARWRENCH® 27 Pc. 1/2" Drive 6 Point SAE Standard and Deep Socket Set

- Surface Drive® Technology Reduces Fastener Rounding
- Chamfered Opening to Guide Fastener Into Socket
- Large Hard-Stamped Size Identification
- Double Line (SAE) and Knurled (Metric) Ring to Easily Identify Standard vs. Metric Sockets
- Full Polish Chrome Finish Cleans Easily and Resists Corrosion
- Meets or Exceeds ASME B107.1



Cat. No.	UPC No.	Packaging	Drive Type	Product Weight
80729	099575807299	Boxed	6 Point	12.31 lb

Cat. No.	Description	Cat. No.	Description
80602	1/2" Drive 6 Point Standard SAE Socket 7/16"	80614	1/2" Drive 6 Point Deep SAE Socket 1/2"
80603	1/2" Drive 6 Point Standard SAE Socket 1/2"	80615	1/2" Drive 6 Point Deep SAE Socket 9/16"
80604	1/2" Drive 6 Point Standard SAE Socket 9/16"	80616	1/2" Drive 6 Point Deep SAE Socket 5/8"
80605	1/2" Drive 6 Point Standard SAE Socket 5/8"	80617	1/2" Drive 6 Point Deep SAE Socket 11/16"
80606	1/2" Drive 6 Point Standard SAE Socket 11/16"	80618	1/2" Drive 6 Point Deep SAE Socket 3/4"
80607D	1/2" Drive 6 Point Standard SAE Socket 3/4"	80619	1/2" Drive 6 Point Deep SAE Socket 13/16"
80608	1/2" Drive 6 Point Standard SAE Socket 13/16"	80620	1/2" Drive 6 Point Deep SAE Socket 7/8"
80609	1/2" Drive 6 Point Standard SAE Socket 7/8"	80621	1/2" Drive 6 Point Deep SAE Socket 15/16"
80610D	1/2" Drive 6 Point Standard SAE Socket 15/16"	80674	1/2" Drive 6 Point Deep SAE Socket 1"
80611	1/2" Drive 6 Point Standard SAE Socket 1"	80675	1/2" Drive 6 Point Deep SAE Socket 1-1/16"
80612	1/2" Drive 6 Point Standard SAE Socket 1-1/16"	80676	1/2" Drive 6 Point Deep SAE Socket 1-1/8"
80613	1/2" Drive 6 Point Standard SAE Socket 1-1/8"	80685	1/2" Drive 6 Point Deep SAE Socket 1-1/4"
80678	1/2" Drive 6 Point Standard SAE Socket 1-1/4"	80686	1/2" Drive 6 Point Deep SAE Socket 1-1/2"
80679	1/2" Drive 6 Point Standard SAE Socket 1-1/2"		

GEARWRENCH® 37 Pc. 1/2" Drive 12 Point Metric Standard and Deep Socket Set

- Surface Drive® Technology Reduces Fastener Rounding
- Chamfered Opening to Guide Fastener Into Socket
- Large Hard-Stamped Size Identification
- Double Line (SAE) and Knurled (Metric) Ring to Easily Identify Standard vs. Metric Sockets
- Full Polish Chrome Finish Cleans Easily and Resists Corrosion
- Meets or Exceeds ASME B107.5M



Cat. No.	UPC No.	Packaging	Drive Type	Product Weight
80730	099575807305	Boxed	12 Point	13.80 lb

Cat. No.	Description	Cat. No.	Description
80806	1/2" Drive 12 Point Standard Metric Socket 9mm	80682	1/2" Drive 12 Point Standard Metric Socket 28mm
80745	1/2" Drive 12 Point Standard Metric Socket 10mm	80683	1/2" Drive 12 Point Standard Metric Socket 29mm
80746	1/2" Drive 12 Point Standard Metric Socket 11mm	80813	1/2" Drive 12 Point Standard Metric Socket 30mm
80747	1/2" Drive 12 Point Standard Metric Socket 12mm	80814D	1/2" Drive 12 Point Standard Metric Socket 32mm
80748D	1/2" Drive 12 Point Standard Metric Socket 13mm	80815D	1/2" Drive 12 Point Standard Metric Socket 36mm
80749	1/2" Drive 12 Point Standard Metric Socket 14mm	80785	1/2" Drive 12 Point Deep Metric Socket 14mm
80750	1/2" Drive 12 Point Standard Metric Socket 15mm	80786	1/2" Drive 12 Point Deep Metric Socket 15mm
80751	1/2" Drive 12 Point Standard Metric Socket 16mm	80787	1/2" Drive 12 Point Deep Metric Socket 16mm
80752	1/2" Drive 12 Point Standard Metric Socket 17mm	80788	1/2" Drive 12 Point Deep Metric Socket 17mm
80753	1/2" Drive 12 Point Standard Metric Socket 18mm	80789	1/2" Drive 12 Point Deep Metric Socket 18mm
80754	1/2" Drive 12 Point Standard Metric Socket 19mm	80790	1/2" Drive 12 Point Deep Metric Socket 19mm
80755D	1/2" Drive 12 Point Standard Metric Socket 20mm	80817D	1/2" Drive 12 Point Deep Metric Socket 20mm
80756	1/2" Drive 12 Point Standard Metric Socket 21mm	80818	1/2" Drive 12 Point Deep Metric Socket 21mm
80757	1/2" Drive 12 Point Standard Metric Socket 22mm	80820	1/2" Drive 12 Point Deep Metric Socket 22mm
80758	1/2" Drive 12 Point Standard Metric Socket 23mm	80822	1/2" Drive 12 Point Deep Metric Socket 24mm
80759	1/2" Drive 12 Point Standard Metric Socket 24mm	80824	1/2" Drive 12 Point Deep Metric Socket 27mm
80811	1/2" Drive 12 Point Standard Metric Socket 25mm	80826	1/2" Drive 12 Point Deep Metric Socket 30mm
80681	1/2" Drive 12 Point Standard Metric Socket 26mm	80827	1/2" Drive 12 Point Deep Metric Socket 32mm
80812	1/2" Drive 12 Point Standard Metric Socket 27mm		

1 / 2 " 3 RATCHETS / SOCKETS / DRIVE TOOLS / SETS

GEARWRENCH® 15 Pc. 1/2" Drive 12 Point SAE Socket Set

- Surface Drive® Technology Reduces Fastener Rounding
- Chamfered Opening to Guide Fastener Into Socket
- Large Hard-Stamped Size Identification
- Double Line (SAE) and Knurled (Metric) Ring to Easily Identify Standard vs. Metric Sockets
- Full Polish Chrome Finish Cleans Easily and Resists Corrosion
- Meets or Exceeds ASME B107.1



Cat. No.	UPC No.	Packaging	Drive Type	Product Weight
80731	099575807312	Boxed	12 Point	4.98 lb

Cat. No.	Description	Cat. No.	Description
80760	1/2" Drive 12 Point Standard SAE Socket 7/16"	80768	1/2" Drive 12 Point Standard SAE Socket 15/16"
80761	1/2" Drive 12 Point Standard SAE Socket 1/2"	80769	1/2" Drive 12 Point Standard SAE Socket 1"
80762	1/2" Drive 12 Point Standard SAE Socket 9/16"	80770	1/2" Drive 12 Point Standard SAE Socket 1-1/16"
80763	1/2" Drive 12 Point Standard SAE Socket 5/8"	80771	1/2" Drive 12 Point Standard SAE Socket 1-1/8"
80764	1/2" Drive 12 Point Standard SAE Socket 11/16"	80793	1/2" Drive 12 Point Standard SAE Socket 1-3/16"
80765	1/2" Drive 12 Point Standard SAE Socket 3/4"	80794	1/2" Drive 12 Point Standard SAE Socket 1-1/4"
80766	1/2" Drive 12 Point Standard SAE Socket 13/16"	80680	1/2" Drive 12 Point Standard SAE Socket 1-1/2"
80767	1/2" Drive 12 Point Standard SAE Socket 7/8"		

GEARWRENCH® 11 Pc. 1/2" Drive 6 Point SAE Socket Set

- Surface Drive® Technology Reduces Fastener Rounding
- Chamfered Opening to Guide Fastener Into Socket
- Large Hard-Stamped Size Identification
- Double Line (SAE) and Knurled (Metric) Ring to Easily Identify Standard vs. Metric Sockets
- Full Polish Chrome Finish Cleans Easily and Resists Corrosion
- Meets or Exceeds ASME B107.1



Cat. No.	UPC No.	Packaging	Drive Type	Product Weight
80703	099575807039	Carded	6 Point	2.87 lb

Cat. No.	Description	Cat. No.	Description
80603	1/2" Drive 6 Point Standard SAE Socket 1/2"	80609	1/2" Drive 6 Point Standard SAE Socket 7/8"
80604	1/2" Drive 6 Point Standard SAE Socket 9/16"	80610D	1/2" Drive 6 Point Standard SAE Socket 15/16"
80605	1/2" Drive 6 Point Standard SAE Socket 5/8"	80611	1/2" Drive 6 Point Standard SAE Socket 1"
80606	1/2" Drive 6 Point Standard SAE Socket 11/16"	80612	1/2" Drive 6 Point Standard SAE Socket 1-1/16"
80607D	1/2" Drive 6 Point Standard SAE Socket 3/4"	80613	1/2" Drive 6 Point Standard SAE Socket 1-1/8"
80608	1/2" Drive 6 Point Standard SAE Socket 13/16"		

GEARWRENCH® 11 Pc. 1/2" Drive 12 Point SAE Socket Set

- Surface Drive® Technology Reduces Fastener Rounding
- Chamfered Opening to Guide Fastener Into Socket
- Large Hard-Stamped Size Identification
- Double Line (SAE) and Knurled (Metric) Ring to Easily Identify Standard vs. Metric Sockets
- Full Polish Chrome Finish Cleans Easily and Resists Corrosion
- Meets or Exceeds ASME B107.1



Cat. No.	UPC No.	Packaging	Drive Type	Product Weight
80711	099575807114	Carded	12 Point	2.86 lb

Cat. No.	Description	Cat. No.	Description
80761	1/2" Drive 12 Point Standard SAE Socket 1/2"	80767	1/2" Drive 12 Point Standard SAE Socket 7/8"
80762	1/2" Drive 12 Point Standard SAE Socket 9/16"	80768	1/2" Drive 12 Point Standard SAE Socket 15/16"
80763	1/2" Drive 12 Point Standard SAE Socket 5/8"	80769	1/2" Drive 12 Point Standard SAE Socket 1"
80764	1/2" Drive 12 Point Standard SAE Socket 11/16"	80770	1/2" Drive 12 Point Standard SAE Socket 1-1/16"
80765	1/2" Drive 12 Point Standard SAE Socket 3/4"	80771	1/2" Drive 12 Point Standard SAE Socket 1-1/8"
80766	1/2" Drive 12 Point Standard SAE Socket 13/16"		

GEARWRENCH® 14 Pc. 1/2" Drive 6 Point SAE Deep Socket Set

- Surface Drive® Technology Reduces Fastener Rounding
- Chamfered Opening to Guide Fastener Into Socket
- Large Hard-Stamped Size Identification
- Double Line (SAE) and Knurled (Metric) Ring to Easily Identify Standard vs. Metric Sockets
- Full Polish Chrome Finish Cleans Easily and Resists Corrosion
- Meets or Exceeds ASME B107.1



Cat. No.	UPC No.	Packaging	Drive Type	Product Weight
80733	099575807336	Boxed	6 Point	8.74 lb

Cat. No.	Description	Cat. No.	Description
80684	1/2" Drive 6 Point Deep SAE Socket 7/16"	80620	1/2" Drive 6 Point Deep SAE Socket 7/8"
80614	1/2" Drive 6 Point Deep SAE Socket 1/2"	80621	1/2" Drive 6 Point Deep SAE Socket 15/16"
80615	1/2" Drive 6 Point Deep SAE Socket 9/16"	80674	1/2" Drive 6 Point Deep SAE Socket 1"
80616	1/2" Drive 6 Point Deep SAE Socket 5/8"	80675	1/2" Drive 6 Point Deep SAE Socket 1-1/16"
80617	1/2" Drive 6 Point Deep SAE Socket 11/16"	80676	1/2" Drive 6 Point Deep SAE Socket 1-1/8"
80618	1/2" Drive 6 Point Deep SAE Socket 3/4"	80685	1/2" Drive 6 Point Deep SAE Socket 1-1/4"
80619	1/2" Drive 6 Point Deep SAE Socket 13/16"	80686	1/2" Drive 6 Point Deep SAE Socket 1-1/2"

1 / 2 "

3

RATCHETS / SOCKETS / DRIVE TOOLS / SETS

GEARWRENCH® 14 Pc. 1/2" Drive 12 Point SAE Deep Socket Set

- Surface Drive® Technology Reduces Fastener Rounding
- Chamfered Opening to Guides Fastener Into Socket
- Large Hard-Stamped Size Identification
- Double Line (SAE) and Knurled (Metric) Ring to Easily Identify Standard vs. Metric Sockets
- Full Polish Chrome Finish Cleans Easily and Resists Corrosion
- Meets or Exceeds ASME B107.1



Cat. No.	UPC No.	Packaging	Drive Type	Product Weight
80732	099575807329	Boxed	12 Point	8.74 lb

Cat. No.	Description	Cat. No.	Description
80772	1/2" Drive 12 Point Deep SAE Socket 7/16"	80779	1/2" Drive 12 Point Deep SAE Socket 7/8"
80773	1/2" Drive 12 Point Deep SAE Socket 1/2"	80780	1/2" Drive 12 Point Deep SAE Socket 15/16"
80774	1/2" Drive 12 Point Deep SAE Socket 9/16"	80795	1/2" Drive 12 Point Deep SAE Socket 1"
80775	1/2" Drive 12 Point Deep SAE Socket 5/8"	80796	1/2" Drive 12 Point Deep SAE Socket 1-1/16"
80776	1/2" Drive 12 Point Deep SAE Socket 11/16"	80797	1/2" Drive 12 Point Deep SAE Socket 1-1/8"
80777D	1/2" Drive 12 Point Deep SAE Socket 3/4"	80798	1/2" Drive 12 Point Deep Socket 1-1/4"
80778	1/2" Drive 12 Point Deep SAE Socket 13/16"	80687	1/2" Drive 12 Point Deep SAE Socket 1-1/2"

GEARWRENCH® 8 Pc. 1/2" Drive 6 Point SAE Deep Socket Set

- Surface Drive® Technology Reduces Fastener Rounding
- Chamfered Opening to Guide Fastener Into Socket
- Large Hard-Stamped Size Identification
- Double Line (SAE) and Knurled (Metric) Ring to Easily Identify Standard vs. Metric Sockets
- Full Polish Chrome Finish Cleans Easily and Resists Corrosion
- Meets or Exceeds ASME B107.1



Cat. No.	UPC No.	Packaging	Drive Type	Product Weight
80705	099575807053	Carded	6 Point	2.87 lb

Cat. No.	Description	Cat. No.	Description
80614	1/2" Drive 6 Point Deep SAE Socket 1/2"	80618	1/2" Drive 6 Point Deep SAE Socket 3/4"
80615	1/2" Drive 6 Point Deep SAE Socket 9/16"	80619	1/2" Drive 6 Point Deep SAE Socket 13/16"
80616	1/2" Drive 6 Point Deep SAE Socket 5/8"	80620	1/2" Drive 6 Point Deep SAE Socket 7/8"
80617	1/2" Drive 6 Point Deep SAE Socket 11/16"	80621	1/2" Drive 6 Point Deep SAE Socket 15/16"

GEARWRENCH® 8 Pc. 1/2" Drive 12 Point SAE Deep Socket Set

- Surface Drive® Technology Reduces Fastener Rounding
- Chamfered Opening to Guide Fastener Into Socket
- Large Hard-Stamped Size Identification
- Double Line (SAE) and Knurled (Metric) Ring to Easily Identify Standard vs. Metric Sockets
- Full Polish Chrome Finish Cleans Easily and Resists Corrosion
- Meets or Exceeds ASME B107.1



Cat. No.	UPC No.	Packaging	Drive Type	Product Weight
80713	099575807138	Carded	12 Point	2.86 lb

Cat. No.	Description	Cat. No.	Description
80773	1/2" Drive 12 Point Deep SAE Socket 1/2"	80777D	1/2" Drive 12 Point Deep SAE Socket 3/4"
80774	1/2" Drive 12 Point Deep SAE Socket 9/16"	80778	1/2" Drive 12 Point Deep SAE Socket 13/16"
80775	1/2" Drive 12 Point Deep SAE Socket 5/8"	80779	1/2" Drive 12 Point Deep SAE Socket 7/8"
80776	1/2" Drive 12 Point Deep SAE Socket 11/16"	80780	1/2" Drive 12 Point Deep SAE Socket 15/16"

GEARWRENCH® 13 Pc. 1/2" Drive 6 Point Metric Socket Set

- Surface Drive® Technology Reduces Fastener Rounding
- Chamfered Opening to Guide Fastener Into Socket
- Large Hard-Stamped Size Identification
- Double Line (SAE) and Knurled (Metric) Ring to Easily Identify Standard vs. Metric Sockets
- Full Polish Chrome Finish Cleans Easily and Resists Corrosion
- Meets or Exceeds ASME B107.5M



Cat. No.	UPC No.	Packaging	Drive Type	Product Weight
80702	099575807022	Carded	6 Point	2.65 lb

Cat. No.	Description	Cat. No.	Description
80624	1/2" Drive 6 Point Standard Metric Socket 12mm	80631	1/2" Drive 6 Point Standard Metric Socket 19mm
80625	1/2" Drive 6 Point Standard Metric Socket 13mm	80632	1/2" Drive 6 Point Standard Metric Socket 20mm
80626D	1/2" Drive 6 Point Standard Metric Socket 14mm	80633	1/2" Drive 6 Point Standard Metric Socket 21mm
80627	1/2" Drive 6 Point Standard Metric Socket 15mm	80634	1/2" Drive 6 Point Standard Metric Socket 22mm
80628	1/2" Drive 6 Point Standard Metric Socket 16mm	80635	1/2" Drive 6 Point Standard Metric Socket 23mm
80629	1/2" Drive 6 Point Standard Metric Socket 17mm	80636D	1/2" Drive 6 Point Standard Metric Socket 24mm
80630	1/2" Drive 6 Point Standard Metric Socket 18mm		

1 / 2 "

3

RATCHETS / SOCKETS / DRIVE TOOLS / SETS

GEARWRENCH® 13 Pc. 1/2" Drive 12 Point Metric Socket Set

- Surface Drive® Technology Reduces Fastener Rounding
- Chamfered Opening to Guide Fastener Into Socket
- Large Hard-Stamped Size Identification
- Double Line (SAE) and Knurled (Metric) Ring to Easily Identify Standard vs. Metric Sockets
- Full Polish Chrome Finish Cleans Easily and Resists Corrosion
- Meets or Exceeds ASME B107.5M



Cat. No.	UPC No.	Packaging	Drive Type	Product Weight
80710D	099575807107	Carded	12 Point	2.55 lb

Cat. No.	Description	Cat. No.	Description
80747	1/2" Drive 12 Point Standard Metric Socket 12mm	80754	1/2" Drive 12 Point Standard Metric Socket 19mm
80748D	1/2" Drive 12 Point Standard Metric Socket 13mm	80755D	1/2" Drive 12 Point Standard Metric Socket 20mm
80749	1/2" Drive 12 Point Standard Metric Socket 14mm	80756	1/2" Drive 12 Point Standard Metric Socket 21mm
80750	1/2" Drive 12 Point Standard Metric Socket 15mm	80757	1/2" Drive 12 Point Standard Metric Socket 22mm
80751	1/2" Drive 12 Point Standard Metric Socket 16mm	80758	1/2" Drive 12 Point Standard Metric Socket 23mm
80752	1/2" Drive 12 Point Standard Metric Socket 17mm	80759	1/2" Drive 12 Point Standard Metric Socket 24mm
80753	1/2" Drive 12 Point Standard Metric Socket 18mm		

GEARWRENCH® 10 Pc. 1/2" Drive 6 Point Metric Deep Socket Set

- Surface Drive® Technology Reduces Fastener Rounding
- Chamfered Opening to Guide Fastener Into Socket
- Large Hard-Stamped Size Identification
- Double Line (SAE) and Knurled (Metric) Ring to Easily Identify Standard vs. Metric Sockets
- Full Polish Chrome Finish Cleans Easily and Resists Corrosion
- Meets or Exceeds ASME B107.5M



Cat. No.	UPC No.	Packaging	Drive Type	Product Weight
80704	099575807046	Carded	6 Point	3.09 lb

Cat. No.	Description	Cat. No.	Description
80637	1/2" Drive 6 Point Deep Metric Socket 10mm	80642	1/2" Drive 6 Point Deep Metric Socket 15mm
80638	1/2" Drive 6 Point Deep Metric Socket 11mm	80643	1/2" Drive 6 Point Deep Metric Socket 16mm
80639	1/2" Drive 6 Point Deep Metric Socket 12mm	80644	1/2" Drive 6 Point Deep Metric Socket 17mm
80640	1/2" Drive 6 Point Deep Metric Socket 13mm	80645	1/2" Drive 6 Point Deep Metric Socket 18mm
80641	1/2" Drive 6 Point Deep Metric Socket 14mm	80646D	1/2" Drive 6 Point Deep Metric Socket 19mm

GEARWRENCH® 10 Pc. 1/2" Drive 12 Point Metric Deep Socket Set

- Surface Drive® Technology Reduces Fastener Rounding
- Chamfered Opening to Guide Fastener Into Socket
- Large Hard-Stamped Size Identification
- Double Line (SAE) and Knurled (Metric) Ring to Easily Identify Standard vs. Metric Sockets
- Full Polish Chrome Finish Cleans Easily and Resists Corrosion
- Meets or Exceeds ASME B107.5M



Cat. No.	UPC No.	Packaging	Drive Type	Product Weight
80712	099575807121	Carded	12 Point	3.11 lb

Cat. No.	Description	Cat. No.	Description
80781	1/2" Drive 12 Point Deep Metric Socket 10mm	80786	1/2" Drive 12 Point Deep Metric Socket 15mm
80782	1/2" Drive 12 Point Deep Metric Socket 11mm	80787	1/2" Drive 12 Point Deep Metric Socket 16mm
80783	1/2" Drive 12 Point Deep Metric Socket 12mm	80788	1/2" Drive 12 Point Deep Metric Socket 17mm
80784	1/2" Drive 12 Point Deep Metric Socket 13mm	80789	1/2" Drive 12 Point Deep Metric Socket 18mm
80785	1/2" Drive 12 Point Deep Metric Socket 14mm	80790	1/2" Drive 12 Point Deep Metric Socket 19mm

GEARWRENCH® 7 Pc. 1/2" Drive SAE Hex Bit Socket Set

- Heat Treated Socket Bases for Durability and Serviceability
- Professional, Full Polish Chrome



Cat. No.	UPC No.	Packaging	Product Weight
80721	099575807213	Carded	2.25 lb

Cat. No.	Description	Cat. No.	Description	Cat. No.	Description
80651	1/2" Drive Hex Bit Socket, 5/16"	80654	1/2" Drive Hex Bit Socket, 1/2"	80657	1/2" Drive Hex Bit Socket, 3/4"
80652	1/2" Drive Hex Bit Socket, 3/8"	80655	1/2" Drive Hex Bit Socket, 9/16"		
80653	1/2" Drive Hex Bit Socket, 7/16"	80656	1/2" Drive Hex Bit Socket, 5/8"		

GEARWRENCH® 7 Pc. 1/2" Drive Metric Hex Bit Socket Set

- Heat Treated Socket Bases for Durability and Serviceability
- Professional, Full Polish Chrome



Cat. No.	UPC No.	Packaging	Product Weight
80720	099575807206	Carded	2.30 lb

Cat. No.	Description	Cat. No.	Description	Cat. No.	Description
80658	1/2" Drive Hex Bit Socket, 6mm	80661	1/2" Drive Hex Bit Socket, 12mm	80664	1/2" Drive Hex Bit Socket, 19mm
80659	1/2" Drive Hex Bit Socket, 8mm	80662	1/2" Drive Hex Bit Socket, 14mm		
80660	1/2" Drive Hex Bit Socket, 10mm	80663	1/2" Drive Hex Bit Socket, 17mm		

1 / 2 "

3

RATCHETS / SOCKETS / DRIVE TOOLS / SETS

GEARWRENCH® 1/2" Drive 120XP™ Teardrop Ratchet



- 120 Positions, 3° Ratcheting Arc
- The Gear is Alternately Engaged by the Double-Stacked Pawls which give a 3° Swing Arc for Faster Work
- Highly Visible On/Off Markings on the Head
- Enclosed Head Design for Extreme Resistance to Dirt Infiltration
- Double-Stacked Pawls Engage a 60-tooth Gear Providing Exceptional Strength, Exceeding ASME Specifications
- Teardrop Low Profile Head and Flush Mounted On/Off Switch Allow Better Access in Tight Spaces
- Longer Reach Handle to Access Hard to Reach Fasteners
- Full Polish Chrome Handle
- Meets or Exceeds ASME B107.10



Cat. No.	UPC No.	Packaging	Overall Length	Head Thickness	No. of Positions	Repair Kit	Product Weight
81304P	099575830402	Carded	11.0 in	0.74 in	120	81339P	1.87 lb

GEARWRENCH® 1/2" Drive 120XP™ Full Polish Teardrop Flex Head Ratchet



- 120 Positions, 3° Ratcheting Arc
- The Gear is Alternately Engaged by the Double-Stacked Pawls which give a 3° Swing Arc for Faster Work
- 6-Position Flex Head for Adjustable Access Angle
- Highly Visible On/Off Markings on the Head
- Enclosed Head Design for Extreme Resistance to Dirt Infiltration
- Double-Stacked Pawls Engage a 60-tooth Gear Providing Exceptional Strength, Exceeding ASME Specifications
- Teardrop Low Profile Head and Flush Mounted On/Off Switch Allow Better Access in Tight Spaces
- Longer Reach Handle to Access Hard to Reach Fasteners
- Full Polish Chrome Handle
- Meets or Exceeds ASME B107.10



Cat. No.	UPC No.	Packaging	Overall Length	Head Width	Head Thickness	No. of Positions	Product Weight
81306P	099575003066	Carded	16.9 in	1.77 in	0.75 in	120	2.44 lb

GEARWRENCH® 1/2" Drive Full Polish Teardrop Ratchet

- Flush Mounted On-Off Lever
- 84 Tooth Teardrop Shaped Head
- Full Polish Chrome Handle
- Bright Chrome Finish
- Meets or Exceeds ASME B107.10



Cat. No.	UPC No.	Packaging	Overall Length	Head Width	Head Thickness	Tooth Count	Repair Kit	Product Weight
81304F	099575813146	Carded	11.0 in	1.72 in	0.64 in	84	81339F	1.85 lb

GEARWRENCH® 1/2" Drive Long Handle Full Polish Teardrop Ratchet

- Full Polish Chrome, Long Handle for Increased Access
- Flush Mounted On-Off Lever
- Teardrop Shaped Head
- Full Polish Chrome Finish
- Meets or Exceeds ASME B107.10



Cat. No.	UPC No.	Packaging	Overall Length	Head Width	Head Thickness	Tooth Count	Repair Kit	Product Weight
81360	099575813603	Carded	15 in	1.72 in	0.64 in	84	81339F	1.97 lb

GEARWRENCH® 1/2" Drive Full Polish Flex Teardrop Ratchet

- Flush Mounted On-Off Lever
- Teardrop Shaped Head
- Full Polish Chrome Handle
- Bright Chrome Finish
- Meets or Exceeds ASME B107.10



Cat. No.	UPC No.	Packaging	Overall Length	Head Width	Head Thickness	Tooth Count	Repair Kit	Product Weight
81306F	099575813160	Carded	16.98 in	1.72 in	0.64 in	84	81339F	2.05 lb

GEARWRENCH® 1/2" Drive Quick-Release Teardrop Ratchet

- Quick-Release Drive Tool Retention
- Teardrop Shaped Head
- Full Polish Chrome Handle
- Bright Chrome Finish
- Meets or Exceeds ASME B107.10



Cat. No.	UPC No.	Packaging	Overall Length	Head Width	Head Thickness	Tooth Count	Product Weight
81309	099575813092	Carded	9.6 in	1.69 in	0.72 in	45	1.45 lb

GEARWRENCH® 1/2" Drive Cushion Grip Teardrop Ratchet

- Quick-Release Drive Tool Retention
- 84 Tooth Teardrop Shaped Head
- Full Polish Chrome Handle
- Bright Chrome Finish
- Meets or Exceeds ASME B107.10



Cat. No.	UPC No.	Packaging	Overall Length	Head Width	Head Thickness	Tooth Count	Repair Kit	Product Weight
81303F	099575830136	Carded	11.610 in	1.69 in	0.64 in	84	81339F	1.30 lb

GEARWRENCH® 1/2" Drive Long Handle Cushion Grip Teardrop Ratchet

- Dual Material Comfort Grip, Long Handle for Increased Access
- Flush Mounted On-Off Lever
- Teardrop Shaped Head
- Full Polish Chrome Finish
- Meets or Exceeds ASME B107.10



Cat. No.	UPC No.	Packaging	Overall Length	Head Width	Head Thickness	Repair Kit	Product Weight
81361	099575813610	Carded	16.5 in	1.72 in	0.64 in	81339F	1.991 lb

1 / 2 "

3

RATCHETS / SOCKETS / DRIVE TOOLS / SETS

GEARWRENCH® 1/2" Drive Ratchet Repair Kits

■ For Non-Quick Release and Non-Roto Ratchets



Cat. No.	UPC No.	Packaging	Description	Fits Product Number	Tooth Count	No. of Positions
81339F	099575811395	Bagged	1/2" Drive Non Quick Release Ratchet Repair Kit	81304, 81306, 81303, 81304F, 81306F, 81303F	84	-
81339P	099575831393	Bagged	1/2" Drive Non-Quick Release Ratchet Repair Kit Dual Pawl 120XP	81304P, 81306P	-	120

GEARWRENCH® 1/2" Drive T-Handle

- T-Handle Slides for Optimum Position
- Full Polish Chrome Finish



Cat. No.	UPC No.	Packaging	Overall Length	Product Weight
81311	099575813115	Carded	15 in	0.95 lb

GEARWRENCH® 1/2" Drive Full Polish Flex Handle / Breaker Bar

- Full Polish Chrome Finish
- Ergonomic Handle
- Meets or Exceeds ASME B107.10



Cat. No.	UPC No.	Packaging	Overall Length	Product Weight
81307	099575813078	Carded	15 in	1.54 lb
81308D	099575813085	Carded	24 in	2.75 lb

GEARWRENCH® 1/2" Drive Universal Joint

- Universal Joint Allows for Greater Access
- Full Polish Chrome finish Cleans Easily and Resists Corrosion



Cat. No.	UPC No.	Packaging	Overall Length	Female Drive Size	Male Drive Size	Product Weight
80600D	099575806001	Carded	2.875 in	1/2"	1/2"	0.33 lb

GEARWRENCH® 1/2" Drive Magnetic Universal Joint

- Strong Magnetic Tips Allow for Contact Through the Base of the Socket to Hold Nuts and Bolts in Place During Use
- Universal Joint Allows for Greater Access



Cat. No.	UPC No.	Packaging	Overall Length	Female Drive Size	Male Drive Size	Product Weight
81257	099575812576	Carded	3.25 in	1/2"	1/2"	0.50 lb

GEARWRENCH® 1/2" Drive Standard Adapters

- Full Polish Chrome Finish Cleans Easily and Resists Corrosion



Cat. No.	UPC No.	Packaging	Overall Length	Female Drive Size	Male Drive Size	Product Weight
81354	099575813542	Carded	1.38 in	1/2"	3/8"	0.06 lb
81355	099575813559	Carded	1.5 in	1/2"	3/4"	0.28 lb

GEARWRENCH® 1/2" Drive Standard Extensions

- Knurled Grip Provides Non-Slip Surface
- Full Polish Chrome finish Cleans Easily and Resists Corrosion



Cat. No.	UPC No.	Packaging	Length	Wobble	Product Weight
81340	099575813405	Carded	3 in	No	0.27 lb
81341	099575813412	Carded	5 in	No	0.44 lb
81342	099575813429	Carded	10 in	No	0.86 lb
81343	099575813436	Carded	15 in	No	1.30 lb

GEARWRENCH® 1/2" Drive Speeder Handle

- Professional, Full Polish Finish
- Spinner Handle Design for Ultra Fast Action



Cat. No.	UPC No.	Packaging	Length	Product Weight
81312	099575813122	Carded	19 in	2.45 lb

GEARWRENCH® 3 Pc. 1/2" Drive Standard Extension Set

- Knurled Grip Provides Non-Slip Surface
- Full Polish Chrome finish Cleans Easily and Resists Corrosion



Cat. No.	UPC No.	Packaging	Product Weight
81300	099575813009	Carded	2.98 lb

Cat. No.	Description	Cat. No.	Description
81341	1/2" Drive Standard Extension 5"	81343	1/2" Drive Standard Extension 15"
81342	1/2" Drive Standard Extension 10"		

GEARWRENCH® 1/2" Drive Magnetic Extension

- Knurled Grip Provides Non-Slip Surface
- Strong Magnetic Tips Allow for Contact Through the Base of the Socket to Hold Nuts and Bolts in Place During Use
- Full Polish Chrome finish Cleans Easily and Resists Corrosion



Cat. No.	UPC No.	Packaging	Length	Wobble	Product Weight
81263	099575812637	Carded	6 in	No	0.70 lb

GEARWRENCH® 1/2" Drive Wobble Extension

- Use as either Standard Extension when Fully Inserted in Socket or as Wobble Extension when Partially Inserted
- Knurled Grip Provides Non-Slip Surface
- Full Polished Chrome Finish



Cat. No.	UPC No.	Packaging	Length	Wobble	Product Weight
81344	099575813443	Carded	3 in	Yes	0.27 lb
81345	099575813450	Carded	5 in	Yes	0.44 lb
81346	099575813467	Carded	10 in	Yes	0.86 lb
81347	099575813474	Carded	15 in	Yes	0.62 lb

GEARWRENCH® 3 Pc. 1/2" Drive Wobble Extension Set

- Use as either Standard Extension when Fully Inserted in Socket or as Wobble Extension when Partially Inserted
- Knurled Grip Provides Non-Slip Surface
- Full Polished Chrome Finish



Cat. No.	UPC No.	Packaging	Product Weight
81301	099575813016	Carded	2.98 lb

Cat. No.	Description	Cat. No.	Description
81345	1/2" Drive Wobble Extension 5"	81347	1/2" Drive Wobble Extension 15"
81346	1/2" Drive Wobble Extension 10"		

GEARWRENCH® 1/2" Drive Locking Extensions

■ Knurled Grip Provides Non-Slip Surface



Cat. No.	UPC No.	Packaging	Length	Wobble	Product Weight
81348	099575813481	Carded	3 in	No	0.29 lb
81349	099575813498	Carded	5 in	No	0.44 lb
81350	099575813504	Carded	10 in	No	0.86 lb

GEARWRENCH® 3 Pc. 1/2" Drive Locking Extension Set

■ Knurled Grip Provides Non-Slip Surface



Cat. No.	UPC No.	Packaging	Product Weight
81302	099575813023	Carded	1.76 lb

Cat. No.	Description	Cat. No.	Description
81348	1/2" Drive Locking Extension 3"	81350	1/2" Drive Locking Extension 10"
81349	1/2" Drive Locking Extension 5"		

1 / 2 "

3 RATCHETS / SOCKETS / DRIVE TOOLS / SETS

GEARWRENCH® 1/2" Drive 6 and 12 Point SAE Standard Length Sockets

- Surface Drive® Technology Reduces Fastener Rounding
- Chamfered Opening to Guide Fastener Into Socket
- Large Hard-Stamped Size Identification
- Double Line (SAE) and Knurled (Metric) Ring to Easily Identify Standard vs. Metric Sockets
- Full Polish Chrome Finish Cleans Easily and Resists Corrosion
- Meets or Exceeds ASME B107.1

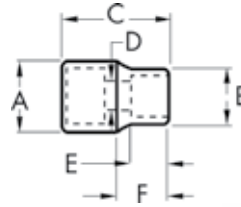

Cat. No.	UPC No.	Packaging	Drive Type	Fastener Size	Dim. A: Drive End	Dim. B: Wrench End	Dim. C: Overall Length	Dim. D: Bolt Clearance	Dim. E: Wrench Depth	Dim. F: Length to Shoulder	Product Weight
80602	099575806025	Carded	6 Point	7/16 in	0.874 in	0.669 in	1.488 in	0.283 in	0.551 in	0.748 in	0.13 lb
80605	099575806056	Carded	6 Point	5/8 in	0.874 in	0.732 in	1.488 in	0.354 in	0.551 in	0.748 in	0.13 lb
80603	099575806032	Carded	6 Point	1/2 in	0.874 in	0.732 in	1.488 in	0.354 in	0.551 in	0.748 in	0.13 lb
80604	099575806049	Carded	6 Point	9/16 in	0.874 in	0.732 in	1.488 in	0.354 in	0.551 in	0.748 in	0.13 lb
80606	099575806063	Carded	6 Point	11/16 in	0.937 in	0.937 in	1.488 in	0.472 in	0.591 in	0.748 in	0.15 lb
80607D	099575806070	Carded	6 Point	3/4 in	1.020 in	1.020 in	1.488 in	0.472 in	0.768 in	0.748 in	0.18 lb
80608	099575806087	Carded	6 Point	13/16 in	1.098 in	1.098 in	1.488 in	0.472 in	0.768 in	0.748 in	0.22 lb
80609	099575806094	Carded	6 Point	7/8 in	1.177 in	1.177 in	1.488 in	0.472 in	0.768 in	0.748 in	0.24 lb
80610D	099575806100	Carded	6 Point	15/16 in	1.256 in	1.256 in	1.488 in	0.472 in	0.807 in	0.748 in	0.29 lb
80611	099575806117	Carded	6 Point	1 in	1.335 in	1.335 in	1.575 in	0.472 in	0.886 in	0.748 in	0.33 lb
80612	099575806124	Carded	6 Point	1-1/16 in	1.413 in	1.413 in	1.575 in	0.472 in	0.886 in	0.748 in	0.38 lb
80613	099575806131	Carded	6 Point	1-1/8 in	1.492 in	1.492 in	1.654 in	0.472 in	0.965 in	0.748 in	0.44 lb
80677	099575806773	Carded	6 Point	1-3/16 in	1.524 in	1.571 in	1.654 in	0.453 in	0.965 in	1.496 in	0.50 lb
80678	099575806780	Carded	6 Point	1-1/4 in	1.602 in	1.650 in	1.654 in	0.453 in	0.965 in	1.496 in	0.50 lb
80679	099575806797	Carded	6 Point	1-1/2 in	1.913 in	1.961 in	1.969 in	0.453 in	1.220 in	1.496 in	0.55 lb
80760	099575807602	Carded	12 Point	7/16 in	0.874 in	0.669 in	1.488 in	0.283 in	0.551 in	0.748 in	0.12 lb
80761	099575807619	Carded	12 Point	1/2 in	0.874 in	0.732 in	1.488 in	0.354 in	0.551 in	0.748 in	0.12 lb
80763	099575807633	Carded	12 Point	5/8 in	0.874 in	0.732 in	1.488 in	0.354 in	0.551 in	0.748 in	0.13 lb
80762	099575807626	Carded	12 Point	9/16 in	0.874 in	0.732 in	1.488 in	0.354 in	0.551 in	0.748 in	0.12 lb
80764	099575807640	Carded	12 Point	11/16 in	0.937 in	0.937 in	1.488 in	0.472 in	0.591 in	0.748 in	0.17 lb
80765	099575807657	Carded	12 Point	3/4 in	1.020 in	1.020 in	1.488 in	0.472 in	0.768 in	0.748 in	0.17 lb
80766	099575807664	Carded	12 Point	13/16 in	1.098 in	1.098 in	1.488 in	0.472 in	0.768 in	0.748 in	0.19 lb
80767	099575807671	Carded	12 Point	7/8 in	1.177 in	1.177 in	1.488 in	0.472 in	0.768 in	0.748 in	0.22 lb
80768	099575807688	Carded	12 Point	15/16 in	1.256 in	1.256 in	1.488 in	0.472 in	0.807 in	0.748 in	0.25 lb
80769	099575807695	Carded	12 Point	1 in	1.335 in	1.335 in	1.575 in	0.472 in	0.886 in	0.748 in	0.32 lb
80770	099575807701	Carded	12 Point	1-1/16 in	1.413 in	1.413 in	1.575 in	0.472 in	0.886 in	0.748 in	0.34 lb
80771	099575807718	Carded	12 Point	1-1/8 in	1.492 in	1.492 in	1.654 in	0.472 in	0.965 in	1.496 in	0.35 lb
80793	099575807930	Carded	12 Point	1-3/16 in	1.524 in	1.571 in	1.654 in	0.472 in	0.965 in	1.496 in	0.45 lb
80794	099575807947	Carded	12 Point	1-1/4 in	1.602 in	1.650 in	1.654 in	0.472 in	0.965 in	1.496 in	0.50 lb
80680	099575806803	Carded	12 Point	1-1/2 in	1.913 in	1.961 in	1.969 in	0.472 in	1.220 in	1.496 in	0.86 lb

GEARWRENCH® 1/2" Drive 6 and 12 Point Metric Standard Length Sockets

- Surface Drive® Technology Reduces Fastener Rounding
- Chamfered Opening to Guide Fastener Into Socket
- Large Hard-Stamped Size Identification
- Double Line (SAE) and Knurled (Metric) Ring to Easily Identify Standard vs. Metric Sockets
- Full Polish Chrome Finish Cleans Easily and Resists Corrosion
- Meets or Exceeds ASME B107.5M

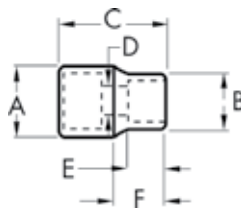

Cat. No.	UPC No.	Packaging	Drive Type	Fastener Size	Dim. A: Drive End	Dim. B: Wrench End	Dim. C: Overall Length	Dim. D: Bolt Clearance	Dim. E: Wrench Depth	Dim. F: Length to Shoulder	Product Weight
80622	099575806223	Carded	6 Point	10 mm	0.866 in	0.602 in	1.488 in	0.283 in	0.551 in	0.748 in	0.11 lb
80623	099575806230	Carded	6 Point	11 mm	0.866 in	0.650 in	1.488 in	0.354 in	0.551 in	0.748 in	0.11 lb
80624	099575806247	Carded	6 Point	12 mm	0.866 in	0.701 in	1.488 in	0.354 in	0.551 in	0.748 in	0.11 lb
80625	099575806254	Carded	6 Point	13 mm	0.866 in	0.748 in	1.488 in	0.421 in	0.551 in	0.748 in	0.12 lb
80626D	099575806261	Carded	6 Point	14 mm	0.866 in	0.799 in	1.488 in	0.421 in	0.571 in	0.748 in	0.12 lb
80627	099575806278	Carded	6 Point	15 mm	0.866 in	0.843 in	1.488 in	0.421 in	0.571 in	0.748 in	0.12 lb
80628	099575806285	Carded	6 Point	16 mm	0.866 in	0.850 in	1.488 in	0.472 in	0.571 in	0.748 in	0.13 lb
80629	099575806292	Carded	6 Point	17 mm	0.941 in	0.941 in	1.488 in	0.472 in	0.591 in	0.748 in	0.15 lb
80630	099575806308	Carded	6 Point	18 mm	0.980 in	0.980 in	1.488 in	0.472 in	0.591 in	0.748 in	0.17 lb
80631	099575806315	Carded	6 Point	19 mm	1.020 in	1.020 in	1.488 in	0.472 in	0.768 in	0.748 in	0.18 lb
80632	099575806322	Carded	6 Point	20 mm	1.094 in	1.094 in	1.488 in	0.472 in	0.768 in	0.748 in	0.18 lb
80633	099575806339	Carded	6 Point	21 mm	1.098 in	1.098 in	1.488 in	0.472 in	0.768 in	0.748 in	0.18 lb
80634	099575806346	Carded	6 Point	22 mm	1.177 in	1.177 in	1.488 in	0.472 in	0.768 in	0.748 in	0.22 lb
80635	099575806353	Carded	6 Point	23 mm	1.256 in	1.256 in	1.488 in	0.472 in	0.807 in	0.748 in	0.26 lb
80636D	099575806360	Carded	6 Point	24 mm	1.256 in	1.256 in	1.488 in	0.472 in	0.807 in	0.748 in	0.28 lb
80805	099575808050	Carded	12 Point	8 mm	0.866 in	0.524 in	1.488 in	0.283 in	0.551 in	0.748 in	0.11 lb
80806	099575808067	Carded	12 Point	9 mm	0.866 in	0.563 in	1.488 in	0.283 in	0.551 in	0.748 in	0.11 lb
80745	099575807459	Carded	12 Point	10 mm	0.866 in	0.602 in	1.488 in	0.283 in	0.551 in	0.748 in	0.11 lb
80746	099575807466	Carded	12 Point	11 mm	0.866 in	0.650 in	1.488 in	0.354 in	0.551 in	0.748 in	0.11 lb
80747	099575807473	Carded	12 Point	12 mm	0.866 in	0.701 in	1.488 in	0.354 in	0.551 in	0.748 in	0.12 lb
80748D	099575807480	Carded	12 Point	13 mm	0.866 in	0.748 in	1.488 in	0.421 in	0.551 in	0.748 in	0.13 lb
80749	099575807497	Carded	12 Point	14 mm	0.866 in	0.799 in	1.488 in	0.421 in	0.571 in	0.748 in	0.13 lb
80750	099575807503	Carded	12 Point	15 mm	0.866 in	0.843 in	1.488 in	0.421 in	0.571 in	0.748 in	0.13 lb
80751	099575807510	Carded	12 Point	16 mm	0.866 in	0.850 in	1.488 in	0.472 in	0.571 in	0.748 in	0.16 lb
80752	099575807527	Carded	12 Point	17 mm	0.941 in	0.941 in	1.488 in	0.472 in	0.591 in	0.748 in	0.17 lb
80753	099575807534	Carded	12 Point	18 mm	0.980 in	0.980 in	1.488 in	0.472 in	0.591 in	0.748 in	0.18 lb
80754	099575807541	Carded	12 Point	19 mm	1.020 in	1.020 in	1.488 in	0.472 in	0.768 in	0.748 in	0.20 lb
80755D	099575807558	Carded	12 Point	20 mm	1.094 in	1.094 in	1.488 in	0.472 in	0.768 in	0.748 in	0.20 lb
80756	099575807565	Carded	12 Point	21 mm	1.098 in	1.098 in	1.488 in	0.472 in	0.768 in	0.748 in	0.22 lb
80757	099575807572	Carded	12 Point	22 mm	1.177 in	1.177 in	1.488 in	0.472 in	0.768 in	0.748 in	0.26 lb
80758	099575807589	Carded	12 Point	23 mm	1.256 in	1.256 in	1.488 in	0.472 in	0.807 in	0.748 in	0.28 lb
80759	099575807596	Carded	12 Point	24 mm	1.256 in	1.256 in	1.488 in	0.472 in	0.807 in	0.748 in	0.28 lb
80811	099575808111	Carded	12 Point	25 mm	1.262 in	1.309 in	1.488 in	0.453 in	0.807 in	0.748 in	0.30 lb
80681	099575806810	Carded	12 Point	26 mm	1.287 in	1.335 in	1.575 in	0.453 in	0.886 in	1.496 in	0.33 lb
80812	099575808128	Carded	12 Point	27 mm	1.366 in	1.413 in	1.575 in	0.453 in	0.886 in	0.748 in	0.33 lb
80682	099575806827	Carded	12 Point	28 mm	1.433 in	1.480 in	1.575 in	0.453 in	0.886 in	1.496 in	0.35 lb

1 / 2 "

3

RATCHETS / SOCKETS / DRIVE TOOLS / SETS

Cat. No.	UPC No.	Packaging	Drive Type	Fastener Size	Dim. A: Drive End	Dim. B: Wrench End	Dim. C: Overall Length	Dim. D: Bolt Clearance	Dim. E: Wrench Depth	Dim. F: Length to Shoulder	Product Weight
80683	099575806834	Carded	12 Point	29 mm	1.445 in	1.492 in	1.575 in	0.453 in	0.886 in	1.496 in	0.35 lb
80813	099575808135	Carded	12 Point	30 mm	1.524 in	1.571 in	1.654 in	0.453 in	0.965 in	0.748 in	0.35 lb
80814D	099575808142	Carded	12 Point	32 mm	1.602 in	1.650 in	1.654 in	0.453 in	0.965 in	0.748 in	0.37 lb
80815D	099575808159	Carded	12 Point	36 mm	1.921 in	1.969 in	1.969 in	0.453 in	1.102 in	0.748 in	0.39 lb

GEARWRENCH® 1/2" Drive 6 and 12 Point SAE Deep Length Sockets

- Surface Drive® Technology Reduces Fastener Rounding
- Chamfered Opening to Guide Fastener Into Socket
- Large Hard-Stamped Size Identification
- Double Line (SAE) and Knurled (Metric) Ring to Easily Identify Standard vs. Metric Sockets
- Full Polish Chrome Finish Cleans Easily and Resists Corrosion
- Meets or Exceeds ASME B107.1

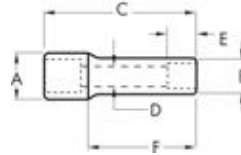

Cat. No.	UPC No.	Packaging	Drive Type	Fastener Size	Dim. A: Drive End	Dim. B: Wrench End	Dim. C: Overall Length	Dim. D: Bolt Clearance	Dim. E: Wrench Depth	Dim. F: Length to Shoulder	Product Weight
80684	099575806841	Carded	6 Point	7/16 in	0.866 in	0.669 in	3.031 in	0.394 in	0.000 in	1.496 in	0.22 lb
80614	099575806148	Carded	6 Point	1/2 in	0.866 in	0.732 in	3.031 in	0.453 in	0.287 in	1.496 in	0.24 lb
80615	099575806155	Carded	6 Point	9/16 in	0.866 in	0.811 in	3.031 in	0.453 in	0.350 in	1.496 in	0.27 lb
80616	099575806162	Carded	6 Point	5/8 in	0.866 in	0.850 in	3.031 in	0.453 in	0.398 in	1.496 in	0.27 lb
80617	099575806179	Carded	6 Point	11/16 in	0.937 in	0.937 in	3.031 in	0.453 in	0.398 in	1.496 in	0.31 lb
80618	099575806186	Carded	6 Point	3/4 in	1.016 in	1.016 in	3.031 in	0.453 in	0.457 in	1.496 in	0.38 lb
80619	099575806193	Carded	6 Point	13/16 in	1.094 in	1.094 in	3.031 in	0.453 in	0.480 in	1.496 in	0.42 lb
80620	099575806209	Carded	6 Point	7/8 in	1.173 in	1.173 in	3.031 in	0.453 in	0.520 in	1.496 in	0.51 lb
80621	099575806216	Carded	6 Point	15/16 in	1.252 in	1.252 in	3.031 in	0.453 in	0.567 in	1.496 in	0.57 lb
80674	099575806742	Carded	6 Point	1 in	1.283 in	1.331 in	3.031 in	0.453 in	0.457 in	1.496 in	0.80 lb
80675	099575806759	Carded	6 Point	1-1/16 in	1.362 in	1.409 in	3.031 in	0.453 in	0.457 in	1.496 in	0.90 lb
80676	099575806766	Carded	6 Point	1-1/8 in	1.441 in	1.488 in	3.031 in	0.453 in	0.457 in	1.496 in	0.99 lb
80685	099575806858	Carded	6 Point	1-1/4 in	1.598 in	1.646 in	3.031 in	0.453 in	0.000 in	0.000 in	1.15 lb
80686	099575806865	Carded	6 Point	1-1/2 in	1.913 in	1.961 in	1.969 in	0.000 in	1.220 in	0.000 in	1.37 lb
80772	099575807725	Carded	12 Point	7/16 in	0.870 in	0.670 in	3.030 in	0.390 in	0.240 in	1.500 in	0.22 lb
80773	099575807732	Carded	12 Point	1/2 in	0.866 in	0.732 in	3.031 in	0.453 in	0.287 in	1.496 in	0.24 lb
80774	099575807749	Carded	12 Point	9/16 in	0.866 in	0.811 in	3.031 in	0.453 in	0.350 in	1.496 in	0.27 lb
80775	099575807756	Carded	12 Point	5/8 in	0.866 in	0.850 in	3.031 in	0.453 in	0.398 in	1.496 in	0.27 lb
80776	099575807763	Carded	12 Point	11/16 in	0.937 in	0.937 in	3.031 in	0.453 in	0.398 in	1.496 in	0.31 lb
80777D	099575807770	Carded	12 Point	3/4 in	1.016 in	1.016 in	3.031 in	0.453 in	0.457 in	1.496 in	0.38 lb
80778	099575807787	Carded	12 Point	13/16 in	1.094 in	1.094 in	3.031 in	0.453 in	0.480 in	1.496 in	0.42 lb
80779	099575807794	Carded	12 Point	7/8 in	1.173 in	1.173 in	3.031 in	0.453 in	0.520 in	1.496 in	0.51 lb
80780	099575807800	Carded	12 Point	15/16 in	1.252 in	1.252 in	3.031 in	0.453 in	0.567 in	1.496 in	0.57 lb
80795	099575807954	Carded	12 Point	1 in	1.283 in	1.331 in	3.031 in	0.453 in	0.642 in	1.496 in	0.80 lb
80796	099575807961	Carded	12 Point	1-1/16 in	1.362 in	1.409 in	3.031 in	0.453 in	0.677 in	1.496 in	0.90 lb
80797	099575807978	Carded	12 Point	1-1/8 in	1.441 in	1.488 in	3.031 in	0.453 in	0.772 in	1.496 in	0.99 lb
80798	099575807985	Carded	12 Point	1-1/4 in	1.598 in	1.646 in	3.031 in	0.453 in	0.870 in	1.496 in	1.15 lb
80687	099575806872	Carded	12 Point	1-1/2 in	1.598 in	1.646 in	3.031 in	0.453 in	0.870 in	1.496 in	1.37 lb

GEARWRENCH® 1/2" Drive 6 and 12 Point Metric Deep Length Sockets

- Surface Drive® Technology Reduces Fastener Rounding
- Chamfered Opening to Guide Fastener Into Socket
- Large Hard-Stamped Size Identification
- Double Line (SAE) and Knurled (Metric) Ring to Easily Identify Standard vs. Metric Sockets
- Full Polish Chrome Finish Cleans Easily and Resists Corrosion
- Meets or Exceeds ASME B107.5M

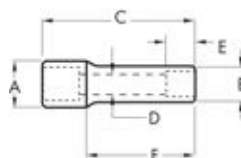

Cat. No.	UPC No.	Packaging	Drive Type	Fastener Size	Dim. A: Drive End	Dim. B: Wrench End	Dim. C: Overall Length	Dim. D: Bolt Clearance	Dim. E: Wrench Depth	Dim. F: Length to Shoulder	Product Weight
80637	099575806377	Carded	6 Point	10 mm	0.866 in	0.602 in	3.031 in	0.374 in	0.201 in	1.496 in	0.23 lb
80638	099575806384	Carded	6 Point	11 mm	0.866 in	0.650 in	3.031 in	0.394 in	0.236 in	1.496 in	0.23 lb
80639	099575806391	Carded	6 Point	12 mm	0.866 in	0.701 in	3.031 in	0.433 in	0.260 in	1.496 in	0.24 lb
80640	099575806407	Carded	6 Point	13 mm	0.866 in	0.748 in	3.031 in	0.453 in	0.287 in	1.496 in	0.25 lb
80641	099575806414	Carded	6 Point	14 mm	0.866 in	0.799 in	3.031 in	0.453 in	0.350 in	1.496 in	0.25 lb
80642	099575806421	Carded	6 Point	15 mm	0.866 in	0.843 in	3.031 in	0.453 in	0.350 in	1.496 in	0.25 lb
80643	099575806438	Carded	6 Point	16 mm	0.866 in	0.850 in	3.031 in	0.453 in	0.398 in	1.496 in	0.29 lb
80644	099575806445	Carded	6 Point	17 mm	0.937 in	0.937 in	3.031 in	0.453 in	0.398 in	1.496 in	0.30 lb
80645	099575806452	Carded	6 Point	18 mm	0.976 in	0.976 in	3.031 in	0.453 in	0.421 in	1.496 in	0.33 lb
80646D	099575806469	Carded	6 Point	19 mm	1.016 in	1.016 in	3.031 in	0.453 in	0.457 in	1.496 in	0.34 lb
80781	099575807817	Carded	12 Point	10 mm	0.866 in	0.602 in	3.031 in	0.374 in	0.201 in	1.496 in	0.23 lb
80782	099575807824	Carded	12 Point	11 mm	0.866 in	0.650 in	3.031 in	0.394 in	0.236 in	1.496 in	0.23 lb
80783	099575807831	Carded	12 Point	12 mm	0.866 in	0.701 in	3.031 in	0.433 in	0.260 in	1.496 in	0.24 lb
80784	099575807848	Carded	12 Point	13 mm	0.866 in	0.748 in	3.031 in	0.453 in	0.287 in	1.496 in	0.25 lb
80785	099575807855	Carded	12 Point	14 mm	0.866 in	0.799 in	3.031 in	0.453 in	0.350 in	1.496 in	0.25 lb
80786	099575807862	Carded	12 Point	15 mm	0.866 in	0.843 in	3.031 in	0.453 in	0.350 in	1.496 in	0.25 lb
80787	099575807879	Carded	12 Point	16 mm	0.866 in	0.850 in	3.031 in	0.453 in	0.398 in	1.496 in	0.29 lb
80788	099575807886	Carded	12 Point	17 mm	0.937 in	0.937 in	3.031 in	0.453 in	0.398 in	1.496 in	0.30 lb
80789	099575807893	Carded	12 Point	18 mm	0.976 in	0.976 in	3.031 in	0.453 in	0.421 in	1.496 in	0.33 lb
80790	099575807909	Carded	12 Point	19 mm	1.016 in	1.016 in	3.031 in	0.453 in	0.457 in	1.496 in	0.34 lb
80817D	099575808173	Carded	12 Point	20 mm	1.047 in	1.094 in	3.031 in	0.453 in	0.480 in	0.748 in	0.40 lb
80818	099575808180	Carded	12 Point	21 mm	1.047 in	1.094 in	3.031 in	0.453 in	0.480 in	0.748 in	0.43 lb
80820	099575808203	Carded	12 Point	22 mm	1.126 in	1.173 in	3.031 in	0.453 in	0.520 in	0.748 in	0.45 lb
80822	099575808227	Carded	12 Point	24 mm	1.205 in	1.252 in	3.031 in	0.453 in	0.567 in	0.748 in	0.46 lb
80824	099575808241	Carded	12 Point	27 mm	1.362 in	1.409 in	3.031 in	0.453 in	0.642 in	0.748 in	0.48 lb
80826	099575808265	Carded	12 Point	30 mm	1.520 in	1.567 in	3.031 in	0.453 in	0.677 in	0.748 in	0.50 lb
80827	099575808272	Carded	12 Point	32 mm	1.598 in	1.646 in	3.031 in	0.453 in	0.772 in	0.748 in	0.55 lb

1 / 2 "

3

RATCHETS / SOCKETS / DRIVE TOOLS / SETS

GEARWRENCH® 1/2" Drive SAE/Metric Hex Bit Sockets

- Heat Treated Socket Bases for Durability and Serviceability
- Professional, Full Polish Chrome

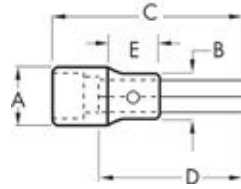

Cat. No.	UPC No.	Packaging	Fastener Size	Dim. A: Drive End	Dim. B: Nose Diameter	Dim. C: Overall Length	Dim. D: Bit Length	Exposed Bit Length	Product Weight
80651	099575806513	Carded	5/16 in	0.944 in	0.665 in	2.480 in	1.490 in	1.097	0.21 lb
80652	099575806520	Carded	3/8 in	0.944 in	0.700 in	2.480 in	1.490 in	1.097	0.23 lb
80653	099575806537	Carded	7/16 in	0.944 in	0.748 in	2.480 in	1.490 in	1.097	0.24 lb
80654	099575806544	Carded	1/2 in	0.944 in	0.944 in	2.480 in	1.490 in	1.097	0.28 lb
80655	099575806551	Carded	9/16 in	1.023 in	1.023 in	2.480 in	1.490 in	1.097	0.33 lb
80656	099575806568	Carded	5/8 in	1.023 in	1.023 in	2.480 in	1.490 in	1.097	0.34 lb
80657	099575806575	Carded	3/4 in	1.102 in	1.102 in	2.480 in	1.490 in	1.097	0.44 lb
80658	099575806582	Carded	6 mm	0.944 in	0.665 in	2.480 in	1.490 in	1.097	0.21 lb
80659	099575806599	Carded	8 mm	0.944 in	0.665 in	2.480 in	1.490 in	1.097	0.23 lb
80660	099575806605	Carded	10 mm	0.944 in	0.748 in	2.480 in	1.490 in	1.097	0.24 lb
80661	099575806612	Carded	12 mm	0.944 in	0.944 in	2.480 in	1.490 in	1.097	0.28 lb
80662	099575806629	Carded	14 mm	1.023 in	1.023 in	2.480 in	1.490 in	1.097	0.33 lb
80663	099575806636	Carded	17 mm	1.102 in	1.102 in	2.480 in	1.490 in	1.097	0.34 lb
80664	099575806643	Carded	19 mm	1.102 in	1.102 in	2.480 in	1.490 in	1.097	0.44 lb

GEARWRENCH® 1/2" Drive Metric Triple Square Bit Sockets

- Heat Treated Socket Bases for Durability and Serviceability
- Professional, Full Polish Chrome

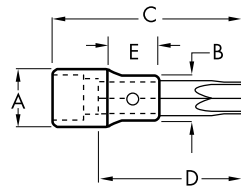

Cat. No.	UPC No.	Packaging	Fastener Size	Dim. A: Drive End	Dim. B: Nose Diameter	Dim. C: Overall Length	Dim. D: Bit Length	Exposed Bit Length	Product Weight
80665	099575806650	Carded	10 mm	0.944 in	0.748 in	4.210 in	3.180 in	2.827	0.38 lb
80666	099575806667	Carded	12 mm	0.944 in	0.944 in	4.680 in	3.660 in	3.297	0.38 lb

GEARWRENCH® 1/2" Drive Torx® Bit Sockets

- Heat Treated Socket Bases for Durability and Serviceability
- Professional, Full Polish Chrome

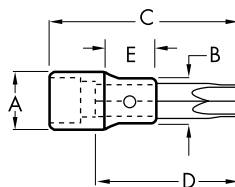

Cat. No.	UPC No.	Packaging	Fastener Size	Dim. A: Drive End	Dim. B: Nose Diameter	Dim. C: Overall Length	Dim. D: Bit Length	Exposed Bit Length	Product Weight
80667	099575806674	Carded	T60	0.944 in	0.944 in	2.480 in	1.490 in	1.097	0.30 lb

GEARWRENCH® 1/2" Drive Torx® Tamper Proof Bit Sockets

- Heat Treated Socket Bases for Durability and Serviceability
- Professional, Full Polish Chrome

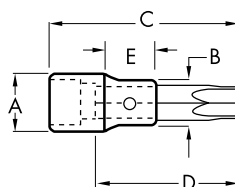

Cat. No.	UPC No.	Packaging	Fastener Size	Dim. A: Drive End	Dim. B: Nose Diameter	Dim. C: Overall Length	Dim. D: Bit Length	Exposed Bit Length	Product Weight
80668	099575806681	Carded	T60	0.944 in	0.944 in	2.480 in	1.490 in	1.097	0.30 lb

GEARWRENCH® 1/2" Drive External Torx® Sockets

- Black Oxide Finish

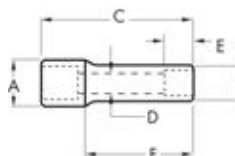

Cat. No.	UPC No.	Packaging	Fastener Size	Dim. A: Drive End	Dim. B: Nose Diameter	Dim. C: Overall Length	Product Weight
80669D	099575806698	Carded	E18	0.944 in	0.944 in	1.500 in	0.30 lb
80670	099575806704	Carded	E20	0.944 in	0.944 in	1.750 in	0.34 lb
80672	099575806728	Carded	E22	1.125 in	1.125 in	2.000 in	0.36 lb
80673	099575806735	Carded	E24	1.125 in	1.125 in	2.000 in	0.38 lb

GEARWRENCH® 27 Pc. 3/4" Drive 12 Point SAE Mechanics Tool Set

- Includes Metal Storage Box
- Full Polish Chrome Sockets With Large Hard Stamp Size Markings
- 24 Tooth Full Polish Chrome Quick-Release Ratchet
- Knurled Full Polish Chrome Extensions
- Full Polish Chrome Flex Handle With Knurled Grip
- Sockets Feature Surface Drive® Technology To Reduce Fastener Rounding
- Meets or Exceeds ASME B107.1, B107.10



Cat. No.	UPC No.	Packaging	Product Weight
80880	099575808807	Boxed	26.40 lb

Cat. No.	Description	Cat. No.	Description	Cat. No.	Description
81400	3/4" Drive Quick Release Ratchet	80834	3/4" Drive 12 Point Socket 1-1/16"	80856	3/4" Drive 12 Point Socket 1-11/16"
81404	3/4" Drive Flex Handle/Breaker Bar 19" Long	80835D	3/4" Drive 12 Point Socket 1-1/8"	80857	3/4" Drive 12 Point Socket 1-3/4"
81401	18" Sliding T Handle	80838	3/4" Drive 12 Point Socket 1-3/16"	80859	3/4" Drive 12 Point Socket 1-13/16"
81411	3/4" Drive Standard Extension 5"	80839	3/4" Drive 12 Point Socket 1-1/4"	80860	3/4" Drive 12 Point Socket 1-7/8"
81412	3/4" Drive Standard Extension 8"	80840	3/4" Drive 12 Point Socket 1-5/16"	80861	3/4" Drive 12 Point Socket 2"
81413	3/4" Drive Standard Extension 16"	80841	3/4" Drive 12 Point Socket 1-3/8"	80862	3/4" Drive 12 Point Socket 2-1/8"
80830	3/4" Drive 12 Point Socket 7/8"	80852	3/4" Drive 12 Point Socket 1-7/16"	80863	3/4" Drive 12 Point Socket 2-3/16"
80831	3/4" Drive 12 Point Socket 15/16"	80854	3/4" Drive 12 Point Socket 1-1/2"	80864	3/4" Drive 12 Point Socket 2-1/4"
80833	3/4" Drive 12 Point Socket 1"	80855D	3/4" Drive 12 Point Socket 1-5/8"	80865	3/4" Drive 12 Point Socket 2-3/8"

GEARWRENCH® 13 Pc. 3/4" Drive 12 Point SAE Mechanics Tool Set

- Includes Metal Storage Box
- Full Polish Chrome Sockets With Large Hard Stamp Size Markings
- 24 Tooth Full Polish Chrome Quick-Release Ratchet
- Knurled Full Polish Chrome Extension
- Sockets Feature Surface Drive® Technology To Reduce Fastener Rounding
- Meets or Exceeds ASME B107.1, B107.10



Cat. No.	UPC No.	Packaging	Product Weight
80879	099575808791	Boxed	18.8 lb

Cat. No.	Description	Cat. No.	Description	Cat. No.	Description
81400	3/4" Drive Quick Release Ratchet	80834	3/4" Drive 12 Point Socket 1-1/16"	80841	3/4" Drive 12 Point Socket 1-3/8"
81412	3/4" Drive Standard Extension 8"	80835D	3/4" Drive 12 Point Socket 1-1/8"	80852	3/4" Drive 12 Point Socket 1-7/16"
80830	3/4" Drive 12 Point Socket 7/8"	80838	3/4" Drive 12 Point Socket 1-3/16"	80854	3/4" Drive 12 Point Socket 1-1/2"
80831	3/4" Drive 12 Point Socket 15/16"	80839	3/4" Drive 12 Point Socket 1-1/4"		
80833	3/4" Drive 12 Point Socket 1"	80840	3/4" Drive 12 Point Socket 1-5/16"		

GEARWRENCH® 3/4" Drive Quick Release Teardrop Ratchet

- Quick-Release Drive Tool Retention
- Teardrop Shaped Head
- Full Polish Chrome Handle
- Bright Chrome Finish



Cat. No.	UPC No.	Packaging	Overall Length	Head Thickness	Tooth Count	Product Weight
81400	099575814006	Carded	19.750 in	1.34 in	24	5.20 lb

GEARWRENCH® 3/4" Drive Ratchet Repair Kit

Cat. No.	UPC No.	Packaging	Description	Fits Product Number	Tooth Count
81499	099575814990	Bagged	3/4" Drive Ratchet Repair Kit	81400	24

GEARWRENCH® 3/4" Drive T-Handle



Cat. No.	UPC No.	Product Weight
81401	099575814013	3.07 lb

GEARWRENCH® 3/4" Drive Flex Handle / Breaker Bar

- Full Polish Chrome Finish
- Ergonomic Handle



Cat. No.	UPC No.	Packaging	Overall Length	Product Weight
81404	099575814044	Carded	19 in	4.07 lb

GEARWRENCH® 3/4" Drive Standard Extensions

- Knurled Grip Provides Non-Slip Surface



Cat. No.	UPC No.	Packaging	Length	Wobble	Product Weight
81411	099575814112	Carded	5 in	No	1.10 lb
81412	099575814129	Carded	8 in	No	2.00 lb
81413	099575814136	Carded	16 in	No	2.58 lb

GEARWRENCH® 3/4" Drive 12 Point SAE Standard Length Sockets

- Surface Drive® Technology Reduces Fastener Rounding
- Chamfered Opening to Guide Fastener Into Socket
- Large Hard-Stamped Size Identification
- Full Polish Chrome Finish Cleans Easily and Resists Corrosion
- Meets or Exceeds ASME B107.1

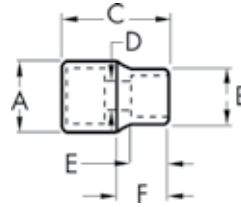

Cat. No.	UPC No.	Packaging	Drive Type	Fastener Size	Dim. A: Drive End	Dim. B: Wrench End	Dim. C: Overall Length	Dim. E: Wrench Depth	Dim. F: Length to Shoulder	Product Weight
80830	099575808302	Carded	12 Point	7/8 in	1.417 in	1.268 in	1.969 in	0.551 in	0.866 in	0.462 lb
80831	099575808319	Carded	12 Point	15/16 in	1.417 in	1.346 in	2.008 in	0.630 in	0.866 in	0.484 lb
80833	099575808333	Carded	12 Point	1 in	1.417 in	1.457 in	2.047 in	0.630 in	1.181 in	0.484 lb
80834	099575808340	Carded	12 Point	1-1/16 in	1.417 in	1.496 in	2.047 in	0.866 in	1.181 in	0.484 lb
80835D	099575808357	Carded	12 Point	1-1/8 in	1.496 in	1.575 in	2.047 in	0.866 in	1.181 in	0.550 lb
80838	099575808388	Carded	12 Point	1-3/16 in	1.496 in	1.654 in	2.126 in	0.945 in	1.260 in	0.594 lb
80839	099575808395	Carded	12 Point	1-1/4 in	1.496 in	1.732 in	2.205 in	0.945 in	1.299 in	0.638 lb
80840	099575808401	Carded	12 Point	1-5/16 in	1.496 in	1.811 in	2.205 in	1.024 in	1.299 in	0.682 lb
80841	099575808418	Carded	12 Point	1-3/8 in	1.654 in	1.890 in	2.283 in	1.024 in	1.378 in	0.814 lb
80852	099575808524	Carded	12 Point	1-7/16 in	1.654 in	1.969 in	2.283 in	1.102 in	1.378 in	0.858 lb
80854	099575808548	Carded	12 Point	1-1/2 in	1.772 in	2.047 in	2.362 in	1.102 in	1.417 in	0.990 lb
80855D	099575808555	Carded	12 Point	1-5/8 in	1.772 in	2.205 in	2.520 in	1.181 in	1.575 in	1.166 lb
80856	099575808562	Carded	12 Point	1-11/16 in	1.772 in	2.283 in	2.559 in	1.260 in	1.535 in	1.210 lb
80857	099575808579	Carded	12 Point	1-3/4 in	1.890 in	2.362 in	2.598 in	1.260 in	1.575 in	1.320 lb
80859	099575808593	Carded	12 Point	1-13/16 in	1.850 in	2.441 in	2.677 in	1.339 in	1.575 in	1.430 lb
80860	099575808609	Carded	12 Point	1-7/8 in	1.890 in	2.520 in	2.756 in	1.339 in	1.654 in	1.540 lb
80861	099575808616	Carded	12 Point	2 in	1.890 in	2.677 in	2.835 in	1.417 in	1.654 in	1.628 lb
80862	099575808623	Carded	12 Point	2-1/8 in	1.890 in	2.835 in	2.913 in	1.496 in	1.732 in	1.804 lb
80863	099575808630	Carded	12 Point	2-3/16 in	1.890 in	2.913 in	2.992 in	1.496 in	1.772 in	1.914 lb
80864	099575808647	Carded	12 Point	2-1/4 in	1.890 in	2.992 in	2.992 in	1.575 in	1.772 in	2.024 lb
80865	099575808654	Carded	12 Point	2-3/8 in	1.890 in	3.150 in	3.071 in	1.575 in	1.811 in	2.200 lb

GEARWRENCH® 27 Pc. 1/4" Drive 6 Point SAE/Metric Pass-Thru® with Locking Flex GearRatchet™ Mechanics Tool Set

- Up to 50% Thinner Head Profile Than Conventional Ratchet Systems
- 11 Locking Head Positions
- 5 Degree Ratcheting Arc
- Up to 40% Stronger Than Traditional Ratchets By Eliminating Drive Tang
- Dual Material Comfort Grip Handle
- Pass-Thru® Ratchet & Socket System Eliminates the Need for Deep Sockets



Cat. No.	UPC No.	Packaging	Product Weight
891427	082171891427	Blow Mold Case	10.37 lb

Cat. No.	Description	Cat. No.	Description
891400	1/4" Drive (13mm) Pass Thru Ratchet XL Locking Flex-Head	522350GR	1/4" Drive (13mm) Vortex Socket 3.5mm
221060GR	1/4" Vortex Extension 3"	522040GR	1/4" Drive (13mm) Vortex Socket 4mm
221080GR	1/4" Vortex Extension 6"	522450GR	1/4" Drive (13mm) Vortex Socket 4.5mm
231061GR	1/4" Drive Pass-Thru® Quick-Release Adapters	522050GR	1/4" Drive (13mm) Vortex Socket 5mm
122050GR	1/4" Drive (13mm) Vortex Socket 5/32"	522550GR	1/4" Drive (13mm) Vortex Socket 5.5mm
122060GR	1/4" Drive (13mm) Vortex Socket 3/16"	522060GR	1/4" Drive (13mm) Vortex Socket 6mm
122070GR	1/4" Drive (13mm) Vortex Socket 7/32"	522070GR	1/4" Drive (13mm) Vortex Socket 7mm
122080GR	1/4" Drive (13mm) Vortex Socket 1/4"	522080GR	1/4" Drive (13mm) Vortex Socket 8mm
122090GR	1/4" Drive (13mm) Vortex Socket 9/32"	522090GR	1/4" Drive (13mm) Vortex Socket 9mm
122100GR	1/4" Drive (13mm) Vortex Socket 5/16"	522100GR	1/4" Drive (13mm) Vortex Socket 10mm
122120GR	1/4" Drive (13mm) Vortex Socket 3/8"	522110GR	1/4" Drive (13mm) Vortex Socket 11mm
122140GR	1/4" Drive (13mm) Vortex Socket 7/16"	522120GR	1/4" Drive (13mm) Vortex Socket 12mm
122160GR	1/4" Drive (13mm) Vortex Socket 1/2"	522130GR	1/4" Drive (13mm) Vortex Socket 13mm
122180GR	1/4" Drive (13mm) Vortex Socket 9/16"		

XL PASS-THRU

3

RATCHETS / SOCKETS / DRIVE TOOLS / SETS

GEARWRENCH® 23 Pc. 3/8" Drive 6 Point SAE/Metric Pass-Thru® with Locking Flex GearRatchet™ Mechanics Tool Set

- Up to 50% Thinner Head Profile Than Conventional Ratchet Systems
- 11 Locking Head Positions
- 5 Degree Ratcheting Arc
- Up to 40% Stronger Than Traditional Ratchets By Eliminating Drive Tang
- Dual Material Comfort Grip Handle
- Pass-Thru® Ratchet & Socket System Eliminates the Need for Deep Sockets



Cat. No.	UPC No.	Packaging	Product Weight
893823	082171893827	Blow Mold Case	4.19 lb

Cat. No.	Description	Cat. No.	Description
893800	3/8" Drive (20mm) Pass Thru Ratchet XL Locking Flex-Head	132280GR	3/8" Vortex Socket 7/8"
231062GR	3/8" Pass-Thru® Quick-Release Adapters	532100GR	3/8" Vortex Socket 10mm
231060GR	3/8" Vortex Extension 3"	532110GR	3/8" Vortex Socket 11mm
231080GR	3/8" Vortex Extension 6"	532120GR	3/8" Vortex Socket 12mm
132120GR	3/8" Vortex Socket 3/8"	532130GR	3/8" Vortex Socket 13mm
132140GR	3/8" Vortex Socket 7/16"	532140GR	3/8" Vortex Socket 14mm
132160GR	3/8" Vortex Socket 1/2"	532150GR	3/8" Vortex Socket 15mm
132180GR	3/8" Vortex Socket 9/16"	532160GR	3/8" Vortex Socket 16mm
132200GR	3/8" Vortex Socket 5/8"	532170GR	3/8" Vortex Socket 17mm
132220GR	3/8" Vortex Socket 11/16"	532180GR	3/8" Vortex Socket 18mm
132240GR	3/8" Vortex Socket 3/4"	532190GR	3/8" Vortex Socket 19mm
132260GR	3/8" Vortex Socket 13/16"		

XL PASS-THRU

3

RATCHETS / SOCKETS / DRIVE TOOLS / SETS

GEARWRENCH® 25 Pc. 1/2" Drive 6 Point SAE/Metric Pass-Thru® with Locking Flex GearRatchet™ Mechanics Tool Set

- Up to 50% Thinner Head Profile Than Conventional Ratchet Systems
- 11 Locking Head Positions
- 5 Degree Ratcheting Arc
- Up to 40% Stronger Than Traditional Ratchets By Eliminating Drive Tang
- Dual Material Comfort Grip Handle
- Pass-Thru® Ratchet & Socket System Eliminates the Need for Deep Sockets



Cat. No.	UPC No.	Packaging	Product Weight
891226	082171891229	Blow Mold Case	9.96 lb

Cat. No.	Description	Cat. No.	Description
891200	1/2" Drive (30mm) Pass Thru Ratchet XL Locking Flex-Head Ratchet	542150GR	1/2" Vortex Socket 15mm
241062GR	1/2" Pass-Thru® Quick-Release Adapters	542160GR	1/2" Vortex Socket 16mm
241080GR	1/2" Vortex Extension 6"	542170GR	1/2" Vortex Socket 17mm
142200GR	1/2" Vortex Socket 5/8"	542180GR	1/2" Vortex Socket 18mm
142220GR	1/2" Vortex Socket 11/16"	542190GR	1/2" Vortex Socket 19mm
142240GR	1/2" Vortex Socket 3/4"	542200GR	1/2" Vortex Socket 20mm
142260GR	1/2" Vortex Socket 13/16"	542210GR	1/2" Vortex Socket 21mm
142280GR	1/2" Vortex Socket 7/8"	542220GR	1/2" Vortex Socket 22mm
142300GR	1/2" Vortex Socket 15/16"	542240GR	1/2" Vortex Socket 24mm
142320GR	1/2" Vortex Socket 1"	542270GR	1/2" Vortex Socket 27mm
142340GR	1/2" Vortex Socket 1-1/16"	542300GR	1/2" Vortex Socket 30mm
142360GR	1/2" Vortex Socket 1-1/8"	542320GR	1/2" Vortex Socket 32mm
142380GR	1/2" Vortex Socket 1-1/4"		

XL PASS-THRU

3

RATCHETS / SOCKETS / DRIVE TOOLS / SETS

GEARWRENCH 39 Pc. 1/4" and 3/8" Drive SAE/Metric Vortex™ Bit Socket Set

- Vortex™ Bit Sockets Are Available in Hex, Torx®, Phillips, and Slotted
- Vortex™ Bit Sockets are Broached for Use with 1/4" and 3/8" Conventional Square Drive Ratchets



Cat. No.	UPC No.	Packaging	Product Weight
890040	082171890147	Blow Mold Case	3.671 lb

Cat. No.	Description	Cat. No.	Description
89014	1/4" Vortex Bit Socket Hex 1/16"	89013D	1/4" Vortex Bit Socket T30
89015	1/4" Vortex Bit Socket Hex 5/64"	89027	3/8" Vortex Bit Socket Hex 9/64"
89016	1/4" Vortex Bit Socket Hex 3/32"	89028	3/8" Vortex Bit Socket Hex 5/32"
89017	1/4" Vortex Bit Socket Hex 7/64"	89029	3/8" Vortex Bit Socket Hex 3/16"
89018	1/4" Vortex Bit Socket Hex 1/8"	89030	3/8" Vortex Bit Socket Hex 7/32"
89019	1/4" Vortex Bit Socket Hex 2mm	89031	3/8" Vortex Bit Socket Hex 1/4"
89020	1/4" Vortex Bit Socket Hex 2.5mm	89032	3/8" Vortex Bit Socket Hex 5/16"
89021	1/4" Vortex Bit Socket Hex 3mm	89033	3/8" Vortex Bit Socket Hex 3/8"
89001D	1/4" Vortex Bit Socket Phillips #1	89034	3/8" Vortex Bit Socket Hex 4mm
89002D	1/4" Vortex Bit Socket Phillips #2	89035	3/8" Vortex Bit Socket Hex 5mm
89003	1/4" Vortex Bit Socket Phillips #3	89036	3/8" Vortex Bit Socket Hex 6mm
89004	1/4" Vortex Bit Socket Slotted 1/8"	89037	3/8" Vortex Bit Socket Hex 7mm
89005	1/4" Vortex Bit Socket Slotted 3/16"	89038	3/8" Vortex Bit Socket Hex 8mm
89006	1/4" Vortex Bit Socket Slotted 1/4"	89039	3/8" Vortex Bit Socket Hex 10mm
89007	1/4" Vortex Bit Socket T8	89022	3/8" Vortex Bit Socket T40
89008	1/4" Vortex Bit Socket T10	89023	3/8" Vortex Bit Socket T45
89009	1/4" Vortex Bit Socket T15	89024D	3/8" Vortex Bit Socket T47
89010	1/4" Vortex Bit Socket T20	89025D	3/8" Vortex Bit Socket T50
89011	1/4" Vortex Bit Socket T25	89026	3/8" Vortex Bit Socket T55
89012	1/4" Vortex Bit Socket T27		

GEARWRENCH Locking Flex GearRatchet™ Handles



Cat. No.	UPC No.	Packaging	Drive Tang Size	Overall Length	Head Thickness	Length	Tooth Count	Product Weight
891400	082171891403	Bagged	1/4 in	6.500 in	0.335 in	-	72	0.28 lb
893800	082171893803	Bagged	3/8 in	12.000 in	0.453 in	-	72	0.93 lb
891200	082171891205	Bagged	1/2 in	15.000 in	9 in	23 in	72	1.94 lb

GEARWRENCH® 1/4" Drive 6 Point SAE Vortex™ Sockets

- Socket System Features the Vortex™ Drive System That Links Drive Tools and Sockets
- Pass-Thru® Socket System Eliminates the Need for Deep Sockets
- Reach Fasteners in Tight Spaces with Ease



Cat. No.	UPC No.	Packaging	Fastener Size	Length	Product Weight
122050GR	082171220500	Carded	5/32 in	0.98 in	0.019 lb
122060GR	082171220609	Carded	3/16 in	0.98 in	0.019 lb
122070GR	082171220708	Carded	7/32 in	0.98 in	0.02 lb
122080GR	082171220807	Carded	1/4 in	0.98 in	0.022 lb
122090GR	082171220906	Carded	9/32 in	1.02 in	0.023 lb
122100GR	082171221002	Carded	5/16 in	1.02 in	0.24 lb
122120GR	082171221200	Carded	3/8 in	1.02 in	0.024 lb
122140GR	082171221408	Carded	7/16 in	1.02 in	0.031 lb
122160GR	082171221606	Carded	1/2 in	1.02 in	0.036 lb
122180GR	082171221804	Carded	9/16 in	1.02 in	0.037 lb

GEARWRENCH® 1/4" Drive 6 Point Metric Vortex™ Sockets

- Socket System Features the Vortex™ Drive System That Links Drive Tools and Sockets
- Pass-Thru® Socket System Eliminates the Need for Deep Sockets
- Reach Fasteners in Tight Spaces with Ease



Cat. No.	UPC No.	Packaging	Fastener Size	Length	Product Weight
522350GR	082171552359	Retail Packaging	3.5 mm	0.98 in	0.02 lb
522040GR	082171220401	Retail Packaging	4 mm	0.98 in	0.02 lb
522450GR	082171522451	Retail Packaging	4.5 mm	0.98 in	0.02 lb
522050GR	082171020506	Retail Packaging	5 mm	0.98 in	0.02 lb
522550GR	082171522550	Retail Packaging	5.5 mm	0.98 in	0.03 lb
522060GR	082171020605	Retail Packaging	6 mm	0.98 in	0.02 lb
522070GR	082171000706	Retail Packaging	7 mm	0.98 in	0.02 lb
522080GR	082171020803	Retail Packaging	8 mm	0.98 in	0.02 lb
522090GR	082171020902	Retail Packaging	9 mm	1.02 in	0.03 lb
522100GR	082171021008	Retail Packaging	10 mm	1.02 in	0.03 lb
522110GR	082171221101	Retail Packaging	11 mm	1.02 in	0.04 lb
522120GR	082171021206	Retail Packaging	12 mm	1.02 in	0.35 lb
522130GR	082171522130	Retail Packaging	13 mm	1.02 in	0.04 lb

XL PASS-THRU

3

RATCHETS / SOCKETS / DRIVE TOOLS / SETS

GEARWRENCH® 3/8" Drive 6 Point SAE Vortex™ Sockets

- Socket System Features the Vortex™ Drive System That Links Drive Tools and Sockets
- Pass-Thru® Socket System Eliminates the Need for Deep Sockets
- Reach Fasteners in Tight Spaces with Ease



Cat. No.	UPC No.	Packaging	Fastener Size	Length	Product Weight
132120GR	082171991134	Carded	3/8 in	1.26 in	0.055 lb
132140GR	082171991141	Carded	7/16 in	1.26 in	0.055 lb
132160GR	082171991158	Carded	1/2 in	1.26 in	0.055 lb
132180GR	082171991165	Carded	9/16 in	1.26 in	0.066 lb
132200GR	082171322006	Carded	5/8 in	1.26 in	0.066 lb
132220GR	082171322204	Carded	11/16 in	1.26 in	0.066 lb
132240GR	082171322402	Carded	3/4 in	1.30 in	0.077 lb
132260GR	082171132261	Carded	13/16 in	1.38 in	0.088 lb
132280GR	082171132285	Carded	7/8 in	1.38 in	0.088 lb

GEARWRENCH® 3/8" Drive 6 Point Metric Vortex™ Sockets

- Socket System Features the Vortex™ Drive System That Links Drive Tools and Sockets
- Pass-Thru® Socket System Eliminates the Need for Deep Sockets
- Reach Fasteners in Tight Spaces with Ease



Cat. No.	UPC No.	Packaging	Fastener Size	Length	Product Weight
532100GR	082171321009	Carded	10 mm	1.26 in	0.055 lb
532110GR	082171321108	Carded	11 mm	1.26 in	0.055 lb
532120GR	082171321207	Carded	12 mm	1.26 in	0.055 lb
532130GR	082171321306	Carded	13 mm	1.26 in	0.055 lb
532140GR	082171321405	Carded	14 mm	1.26 in	0.059 lb
532150GR	082171321504	Carded	15 mm	1.26 in	0.059 lb
532160GR	082171321603	Carded	16 mm	1.26 in	0.066 lb
532170GR	082171321702	Carded	17 mm	1.26 in	0.066 lb
532180GR	082171321801	Carded	18 mm	1.26 in	0.07 lb
532190GR	082171321900	Carded	19 mm	1.30 in	0.077 lb

GEARWRENCH® 1/2" Drive 6 Point SAE Vortex® Sockets

- Socket System Features the Vortex™ Drive System That Links Drive Tools and Sockets
- Pass-Thru® Socket System Eliminates the Need for Deep Sockets
- Reach Fasteners in Tight Spaces with Ease



Cat. No.	UPC No.	Packaging	Fastener Size	Length	Product Weight
142200GR	082171142208	Carded	5/8 in	1.65 in	0.165 lb
142220GR	082171142222	Carded	11/16 in	1.65 in	0.165 lb
142240GR	082171142246	Carded	3/4 in	1.65 in	0.165 lb
142260GR	082171142604	Carded	13/16 in	1.65 in	0.165 lb
142280GR	082171142086	Carded	7/8 in	1.65 in	0.176 lb
142300GR	082171142307	Carded	15/16 in	1.65 in	0.187 lb
142320GR	082171142000	Carded	1 in	1.65 in	0.209 lb
142340GR	082171144004	Carded	1-1/16 in	1.65 in	0.22 lb
142360GR	082171142635	Carded	1-1/8 in	1.77 in	0.264 lb
142380GR	082171142833	Carded	1-1/4 in	1.89 in	0.308 lb

GEARWRENCH® 1/2" Drive 6 Point Metric Vortex® Sockets

- Socket System Features the Vortex™ Drive System That Links Drive Tools and Sockets
- Pass-Thru® Socket System Eliminates the Need for Deep Sockets
- Reach Fasteners in Tight Spaces with Ease



Cat. No.	UPC No.	Packaging	Fastener Size	Length	Product Weight
542150GR	082171542152	Carded	15 mm	1.30 in	0.165 lb
542160GR	082171542169	Carded	16 mm	1.30 in	0.165 lb
542170GR	082171542176	Carded	17 mm	1.30 in	0.165 lb
542180GR	082171542183	Carded	18 mm	1.30 in	0.165 lb
542190GR	082171542190	Carded	19 mm	1.30 in	0.165 lb
542200GR	082171542206	Carded	20 mm	1.30 in	0.172 lb
542210GR	082171542213	Carded	21 mm	1.30 in	0.172 lb
542220GR	082171542220	Carded	22 mm	1.30 in	0.176 lb
542240GR	082171542244	Carded	24 mm	1.30 in	0.187 lb
542270GR	082171542275	Carded	27 mm	1.30 in	0.22 lb
542300GR	082171542305	Carded	30 mm	1.77 in	0.286 lb
542320GR	082171542329	Carded	32 mm	1.89 in	0.308 lb

XL PASS-THRU

3

RATCHETS / SOCKETS / DRIVE TOOLS / SETS

GEARWRENCH® 1/4" Drive SAE/Metric/Torx®/Slotted/Phillips Vortex™ Bit Sockets

- Vortex™ Bit Sockets Are Broached for Use with 1/4" and 3/8" Conventional Square Drive Ratchets
- Available in Hex, Torx®, Phillips, and Slotted



Cat. No.	UPC No.	Packaging	Drive Type	Fastener Size	Length	Product Weight
89001D	082171890017	Carded	Phillips®	#1	1.34 in	0.033 lb
89002D	082171890024	Carded	Phillips®	#2	1.34 in	0.033 lb
89003	082171890031	Carded	Phillips®	#3	1.34 in	0.033 lb
89004	082171890406	Carded	Slotted	1/8 in	1.34 in	0.033 lb
89005	082171890055	Carded	Slotted	3/16 in	1.34 in	0.033 lb
89006	082171890062	Carded	Slotted	1/4 in	1.34 in	0.033 lb
89007	082171890079	Carded	Slotted/Phillips®/Hex/Torx®	T8	1.34 in	0.033 lb
89008	082171890086	Carded	Slotted/Phillips®/Hex/Torx®	T10	1.34 in	0.033 lb
89009	082171890093	Carded	Slotted/Phillips®/Hex/Torx®	T15	1.34 in	0.033 lb
89010	082171890109	Carded	Slotted/Phillips®/Hex/Torx®	T20	1.34 in	0.033 lb
89011	082171890116	Carded	Slotted/Phillips®/Hex/Torx®	T25	1.34 in	0.033 lb
89012	082171890123	Carded	Slotted/Phillips®/Hex/Torx®	T27	1.34 in	0.033 lb
89013D	082171890130	Carded	Slotted/Phillips®/Hex/Torx®	T30	1.34 in	0.033 lb
89014	082171890413	Carded	Slotted/Phillips®/Hex/Torx®	1/16 in	1.34 in	0.033 lb
89015	082171891052	Carded	Slotted/Phillips®/Hex/Torx®	5/64 in	1.34 in	0.033 lb
89016	082171890161	Carded	Slotted/Phillips®/Hex/Torx®	3/32 in	1.34 in	0.033 lb
89017	082171890178	Carded	Slotted/Phillips®/Hex/Torx®	7/64 in	1.34 in	0.033 lb
89018	082171890185	Carded	Slotted/Phillips®/Hex/Torx®	1/8 in	1.34 in	0.033 lb
89019	082171890192	Carded	Slotted/Phillips®/Hex/Torx®	2 mm	1.34 in	0.033 lb
89020	082171890208	Carded	Slotted/Phillips®/Hex/Torx®	2.5 mm	1.34 in	0.033 lb
89021	082171890215	Carded	Slotted/Phillips®/Hex/Torx®	3 mm	1.34 in	0.033 lb

GEARWRENCH® 3/8" Drive SAE/Metric/Torx® Vortex™ Bit Sockets

- Vortex™ Bit Sockets Are Broached for Use with 1/4" and 3/8" Conventional Square Drive Ratchets
- Available in Hex, Torx®, Phillips, and Slotted



Cat. No.	UPC No.	Packaging	Drive Type	Fastener Size	Length	Product Weight
89022	082171890222	Carded	Hex/Torx®	T40	1.80 in	0.128 lb
89023	082171890239	Carded	Hex/Torx®	T45	1.80 in	0.132 lb
89024D	082171890246	Carded	Hex/Torx®	T47	1.80 in	0.132 lb
89025D	082171890253	Carded	Hex/Torx®	T50	1.80 in	0.142 lb
89026	082171890260	Carded	Hex/Torx®	T55	1.80 in	0.143 lb
89027	082171890277	Carded	Hex/Torx®	9/64 in	1.80 in	0.128 lb
89028	082171890284	Carded	Hex/Torx®	5/32 in	1.80 in	0.128 lb
89029	082171890291	Carded	Hex/Torx®	3/16 in	1.80 in	0.132 lb
89030	082171890307	Carded	Hex/Torx®	7/32 in	1.80 in	0.132 lb
89031	082171890314	Carded	Hex/Torx®	1/4 in	1.80 in	0.143 lb
89032	082171890321	Carded	Hex/Torx®	5/16 in	1.80 in	0.143 lb
89033	082171890338	Carded	Hex/Torx®	3/8 in	1.80 in	0.143 lb
89034	082171890345	Carded	Hex/Torx®	4 mm	1.80 in	0.128 lb
89035	082171890352	Carded	Hex/Torx®	5 mm	1.80 in	0.128 lb
89036	082171890369	Carded	Hex/Torx®	6 mm	1.80 in	0.132 lb
89037	082171890376	Carded	Hex/Torx®	7 mm	1.80 in	0.143 lb
89038	082171890383	Carded	Hex/Torx®	8 mm	1.80 in	0.143 lb
89039	082171890390	Carded	Hex/Torx®	10 mm	1.80 in	0.143 lb

GEARWRENCH® Pass-Thru® Quick-Release Adapters

- Adapter Adds Push Button Quick Release Feature



Cat. No.	UPC No.	Packaging	Drive Tang Size	Length	Product Weight
231061GR	082171310614	Carded	1/4 in	0.89 in	0.10 lb
231062GR	082171310621	Carded	3/8 in	1.17 in	0.10 lb
241062GR	082171241604	Carded	1/2 in	1.57 in	0.25 lb

GEARWRENCH® Vortex™ Extensions

■ Pass-Thru® System Eliminates the Need for Deep Sockets



Cat. No.	UPC No.	Packaging	Drive Tang Size	Length	Product Weight
221060GR	082171210600	Carded	1/4 in	3 in	0.08 lb
221080GR	082171221088	Carded	1/4 in	6 in	0.16 lb
231060GR	082171310607	Carded	3/8 in	3 in	0.25 lb
231080GR	082171231087	Carded	3/8 in	6 in	0.36 lb
241080GR	082171241000	Carded	1/2 in	6 in	0.18 lb



GEARWRENCH®

1/4" Drive Sets	191
1/4" Drive Open Stock	197
3/8" Drive Sets	202
3/8" Drive Open Stock.....	207
1/2" Drive Sets	212
1/2" Drive Open Stock.....	218
3/4" Drive Open Stock.....	226

GEARWRENCH® Impact Sockets

GearWrench® offers a full range of sockets from 1/4" to 3/4" drive. Sockets are made of Chrome Molybdenum (Cr-Mo) that outlasts other alloy steels and provides the durability and hardness required for impact applications. The sockets are coated in Manganese Phosphate that gives up to double the protection of standard Black Oxide coatings and are laser and hard stamped with sizes for easy identification. Socket sets come in heavy-duty reinforced cases with steel hinges and buckles.

IMPACT SOCKETS

- AVAILABLE IN:**
- 1/4" Drive
 - 3/8" Drive
 - 1/2" Drive
 - 3/4" Drive
 - Universal Sockets
 - Hex Sockets
 - Adapters & Drive Tools



Reinforced steel hinges for added durability

Reinforced molded cases with sizes marked for quick identification and storage

Steel buckles provide security and strength



Surface Drive™ technology

Chrome Molybdenum Alloy Steel (Cr-Mo) for exceptional strength and long lasting durability

Additional hard stamping (on opposite side)

High visibility laser etched markings



Pin hole available for use with pin and O-ring for secure socket retention

GEARWRENCH® 71 Pc. 1/4" Drive 6 Point SAE/Metric Std./Deep/Universal Impact Socket Set

- Chrome Molybdenum Alloy Steel (Cr-Mo) for Exceptional Strength and Durability
- Surface Drive™ Technology Reduces Fastener Rounding
- Manganese Phosphate Coating to Resist Corrosion
- High Visibility Laser Etched Markings
- Secondary Hard Stamping
- Includes Blow Mold Case
- Meets or Exceeds ASME B107.2/B107.33M



Cat. No.	UPC No.	Packaging	Product Weight
84903	099575849039	Case	8.50 lb

Cat. No.	Description	Cat. No.	Description
84100	1/4" Drive 6 Point Standard Impact Socket 3/16"	84123	1/4" Drive 6 Point Standard Impact Socket 14mm
84101	1/4" Drive 6 Point Standard Impact Socket 7/32"	84124	1/4" Drive 6 Point Standard Impact Socket 15mm
84102	1/4" Drive 6 Point Standard Impact Socket 1/4"	84137	1/4" Drive 6 Point Deep Impact Socket 4mm
84103	1/4" Drive 6 Point Standard Impact Socket 9/32"	84138	1/4" Drive 6 Point Deep Impact Socket 4.5mm
84104	1/4" Drive 6 Point Standard Impact Socket 5/16"	84139	1/4" Drive 6 Point Deep Impact Socket 5mm
84105D	1/4" Drive 6 Point Standard Impact Socket 11/32"	84140	1/4" Drive 6 Point Deep Impact Socket 5.5mm
84106	1/4" Drive 6 Point Standard Impact Socket 3/8"	84141	1/4" Drive 6 Point Deep Impact Socket 6mm
84107	1/4" Drive 6 Point Standard Impact Socket 7/16"	84142	1/4" Drive 6 Point Deep Impact Socket 7mm
84108	1/4" Drive 6 Point Standard Impact Socket 1/2"	84143	1/4" Drive 6 Point Deep Impact Socket 8mm
84109	1/4" Drive 6 Point Standard Impact Socket 9/16"	84144	1/4" Drive 6 Point Deep Impact Socket 9mm
84126	1/4" Drive 6 Point Deep Impact Socket 3/16"	84145	1/4" Drive 6 Point Deep Impact Socket 10mm
84127	1/4" Drive 6 Point Deep Impact Socket 7/32"	84146	1/4" Drive 6 Point Deep Impact Socket 11mm
84128	1/4" Drive 6 Point Deep Impact Socket 1/4"	84147	1/4" Drive 6 Point Deep Impact Socket 12mm
84129	1/4" Drive 6 Point Deep Impact Socket 9/32"	84148	1/4" Drive 6 Point Deep Impact Socket 13mm
84130	1/4" Drive 6 Point Deep Impact Socket 5/16"	84149	1/4" Drive 6 Point Deep Impact Socket 14mm
84131	1/4" Drive 6 Point Deep Impact Socket 11/32"	84150D	1/4" Drive 6 Point Deep Impact Socket 15mm
84132	1/4" Drive 6 Point Deep Impact Socket 3/8"	84152	1/4" Drive Universal Impact Socket 1/4"
84133	1/4" Drive 6 Point Deep Impact Socket 7/16"	84153	1/4" Drive Universal Impact Socket 5/16"
84134	1/4" Drive 6 Point Deep Impact Socket 1/2"	84154	1/4" Drive Universal Impact Socket 3/8"
84135	1/4" Drive 6 Point Deep Impact Socket 9/16"	84155	1/4" Drive Universal Impact Socket 7/16"
84111	1/4" Drive 6 Point Standard Impact Socket 4mm	84156	1/4" Drive Universal Impact Socket 1/2"
84112	1/4" Drive 6 Point Standard Impact Socket 4.5mm	84157	1/4" Drive Universal Impact Socket 9/16"
84113	1/4" Drive 6 Point Standard Impact Socket 5mm	84159	1/4" Drive Universal Impact Socket 5mm
84114	1/4" Drive 6 Point Standard Impact Socket 5.5mm	84160	1/4" Drive Universal Impact Socket 5.5mm
84115	1/4" Drive 6 Point Standard Impact Socket 6mm	84161	1/4" Drive Universal Impact Socket 6mm
84116	1/4" Drive 6 Point Standard Impact Socket 7mm	84162	1/4" Drive Universal Impact Socket 7mm
84117	1/4" Drive 6 Point Standard Impact Socket 8mm	84163	1/4" Drive Universal Impact Socket 8mm
84118	1/4" Drive 6 Point Standard Impact Socket 9mm	84164	1/4" Drive Universal Impact Socket 9mm
84119	1/4" Drive 6 Point Standard Impact Socket 10mm	84165	1/4" Drive Universal Impact Socket 10mm
84120	1/4" Drive 6 Point Standard Impact Socket 11mm	84166	1/4" Drive Universal Impact Socket 11mm
84121	1/4" Drive 6 Point Standard Impact Socket 12mm	84167	1/4" Drive Universal Impact Socket 12mm
84122	1/4" Drive 6 Point Standard Impact Socket 13mm	84168	1/4" Drive Universal Impact Socket 13mm

Contents continued on next page.

1 / 4 " I M P A C T S O C K E T S

Cat. No.	Description	Cat. No.	Description
84169	1/4" Drive Universal Impact Socket 14mm	84172	1/4" Drive Impact Extension 2"
84170	1/4" Drive Universal Impact Socket 15mm	84173	1/4" Drive Impact Extension 4"
80101	1/4" Drive Impact Universal Joint	84174	1/4" Drive Impact Extension 6"
84176	1/4"F x 3/8"M Impact Adapter		

GEARWRENCH® 48 Pc. 1/4" Drive 6 Point SAE/Metric Std./Deep Impact Socket Set

- Chrome Molybdenum Alloy Steel (Cr-Mo) for Exceptional Strength and Durability
- Surface Drive™ Technology Reduces Fastener Rounding
- Manganese Phosphate Coating to Resist Corrosion
- High Visibility Laser Etched Markings
- Secondary Hard Stamping
- Includes Blow Mold Case
- Meets or Exceeds ASME B107.2/B107.33M



Cat. No.	UPC No.	Packaging	Product Weight
84902	099575849022	Case	2.63 lb

Cat. No.	Description	Cat. No.	Description
84100	1/4" Drive 6 Point Standard Impact Socket 3/16"	84115	1/4" Drive 6 Point Standard Impact Socket 6mm
84101	1/4" Drive 6 Point Standard Impact Socket 7/32"	84116	1/4" Drive 6 Point Standard Impact Socket 7mm
84102	1/4" Drive 6 Point Standard Impact Socket 1/4"	84117	1/4" Drive 6 Point Standard Impact Socket 8mm
84103	1/4" Drive 6 Point Standard Impact Socket 9/32"	84118	1/4" Drive 6 Point Standard Impact Socket 9mm
84104	1/4" Drive 6 Point Standard Impact Socket 5/16"	84119	1/4" Drive 6 Point Standard Impact Socket 10mm
84105D	1/4" Drive 6 Point Standard Impact Socket 11/32"	84120	1/4" Drive 6 Point Standard Impact Socket 11mm
84106	1/4" Drive 6 Point Standard Impact Socket 3/8"	84121	1/4" Drive 6 Point Standard Impact Socket 12mm
84107	1/4" Drive 6 Point Standard Impact Socket 7/16"	84122	1/4" Drive 6 Point Standard Impact Socket 13mm
84108	1/4" Drive 6 Point Standard Impact Socket 1/2"	84123	1/4" Drive 6 Point Standard Impact Socket 14mm
84109	1/4" Drive 6 Point Standard Impact Socket 9/16"	84124	1/4" Drive 6 Point Standard Impact Socket 15mm
84126	1/4" Drive 6 Point Deep Impact Socket 3/16"	84137	1/4" Drive 6 Point Deep Impact Socket 4mm
84127	1/4" Drive 6 Point Deep Impact Socket 7/32"	84138	1/4" Drive 6 Point Deep Impact Socket 4.5mm
84128	1/4" Drive 6 Point Deep Impact Socket 1/4"	84139	1/4" Drive 6 Point Deep Impact Socket 5mm
84129	1/4" Drive 6 Point Deep Impact Socket 9/32"	84140	1/4" Drive 6 Point Deep Impact Socket 5.5mm
84130	1/4" Drive 6 Point Deep Impact Socket 5/16"	84141	1/4" Drive 6 Point Deep Impact Socket 6mm
84131	1/4" Drive 6 Point Deep Impact Socket 11/32"	84142	1/4" Drive 6 Point Deep Impact Socket 7mm
84132	1/4" Drive 6 Point Deep Impact Socket 3/8"	84143	1/4" Drive 6 Point Deep Impact Socket 8mm
84133	1/4" Drive 6 Point Deep Impact Socket 7/16"	84144	1/4" Drive 6 Point Deep Impact Socket 9mm
84134	1/4" Drive 6 Point Deep Impact Socket 1/2"	84145	1/4" Drive 6 Point Deep Impact Socket 10mm
84135	1/4" Drive 6 Point Deep Impact Socket 9/16"	84146	1/4" Drive 6 Point Deep Impact Socket 11mm
84111	1/4" Drive 6 Point Standard Impact Socket 4mm	84147	1/4" Drive 6 Point Deep Impact Socket 12mm
84112	1/4" Drive 6 Point Standard Impact Socket 4.5mm	84148	1/4" Drive 6 Point Deep Impact Socket 13mm
84113	1/4" Drive 6 Point Standard Impact Socket 5mm	84149	1/4" Drive 6 Point Deep Impact Socket 14mm
84114	1/4" Drive 6 Point Standard Impact Socket 5.5mm	84150D	1/4" Drive 6 Point Deep Impact Socket 15mm

GEARWRENCH® 20 Pc. 1/4" Drive 6 Point SAE Std./Deep Impact Socket Set

- Chrome Molybdenum Alloy Steel (Cr-Mo) for Exceptional Strength and Durability
- Surface Drive™ Technology Reduces Fastener Rounding
- Manganese Phosphate Coating to Resist Corrosion
- High Visibility Laser Etched Markings
- Secondary Hard Stamping
- Includes Blow Mold Case
- Meets or Exceeds ASME B107.2



Cat. No.	UPC No.	Packaging	Product Weight
84900	099575849008	Case	2.25 lb

Cat. No.	Description	Cat. No.	Description
84100	1/4" Drive 6 Point Standard Impact Socket 3/16"	84126	1/4" Drive 6 Point Deep Impact Socket 3/16"
84101	1/4" Drive 6 Point Standard Impact Socket 7/32"	84127	1/4" Drive 6 Point Deep Impact Socket 7/32"
84102	1/4" Drive 6 Point Standard Impact Socket 1/4"	84128	1/4" Drive 6 Point Deep Impact Socket 1/4"
84103	1/4" Drive 6 Point Standard Impact Socket 9/32"	84129	1/4" Drive 6 Point Deep Impact Socket 9/32"
84104	1/4" Drive 6 Point Standard Impact Socket 5/16"	84130	1/4" Drive 6 Point Deep Impact Socket 5/16"
84105D	1/4" Drive 6 Point Standard Impact Socket 11/32"	84131	1/4" Drive 6 Point Deep Impact Socket 11/32"
84106	1/4" Drive 6 Point Standard Impact Socket 3/8"	84132	1/4" Drive 6 Point Deep Impact Socket 3/8"
84107	1/4" Drive 6 Point Standard Impact Socket 7/16"	84133	1/4" Drive 6 Point Deep Impact Socket 7/16"
84108	1/4" Drive 6 Point Standard Impact Socket 1/2"	84134	1/4" Drive 6 Point Deep Impact Socket 1/2"
84109	1/4" Drive 6 Point Standard Impact Socket 9/16"	84135	1/4" Drive 6 Point Deep Impact Socket 9/16"

1 / 4 "

4
I M P A C T S O C K E T S

GEARWRENCH® 28 Pc. 1/4" Drive 6 Point Metric Std/Deep Impact Socket Set

- Chrome Molybdenum Alloy Steel (Cr-Mo) for Exceptional Strength and Durability
- Surface Drive™ Technology Reduces Fastener Rounding
- Manganese Phosphate Coating to Resist Corrosion
- High Visibility Laser Etched Markings
- Secondary Hard Stamping
- Includes Blow Mold Case
- Meets or Exceeds ASME B107.33M



Cat. No.	UPC No.	Packaging	Product Weight
84901	099575849015	Case	2.88 lb

Cat. No.	Description	Cat. No.	Description
84111	1/4" Drive 6 Point Standard Impact Socket 4mm	84137	1/4" Drive 6 Point Deep Impact Socket 4mm
84112	1/4" Drive 6 Point Standard Impact Socket 4.5mm	84138	1/4" Drive 6 Point Deep Impact Socket 4.5mm
84113	1/4" Drive 6 Point Standard Impact Socket 5mm	84139	1/4" Drive 6 Point Deep Impact Socket 5mm
84114	1/4" Drive 6 Point Standard Impact Socket 5.5mm	84140	1/4" Drive 6 Point Deep Impact Socket 5.5mm
84115	1/4" Drive 6 Point Standard Impact Socket 6mm	84141	1/4" Drive 6 Point Deep Impact Socket 6mm
84116	1/4" Drive 6 Point Standard Impact Socket 7mm	84142	1/4" Drive 6 Point Deep Impact Socket 7mm
84117	1/4" Drive 6 Point Standard Impact Socket 8mm	84143	1/4" Drive 6 Point Deep Impact Socket 8mm
84118	1/4" Drive 6 Point Standard Impact Socket 9mm	84144	1/4" Drive 6 Point Deep Impact Socket 9mm
84119	1/4" Drive 6 Point Standard Impact Socket 10mm	84145	1/4" Drive 6 Point Deep Impact Socket 10mm
84120	1/4" Drive 6 Point Standard Impact Socket 11mm	84146	1/4" Drive 6 Point Deep Impact Socket 11mm
84121	1/4" Drive 6 Point Standard Impact Socket 12mm	84147	1/4" Drive 6 Point Deep Impact Socket 12mm
84122	1/4" Drive 6 Point Standard Impact Socket 13mm	84148	1/4" Drive 6 Point Deep Impact Socket 13mm
84123	1/4" Drive 6 Point Standard Impact Socket 14mm	84149	1/4" Drive 6 Point Deep Impact Socket 14mm
84124	1/4" Drive 6 Point Standard Impact Socket 15mm	84150D	1/4" Drive 6 Point Deep Impact Socket 15mm

GEARWRENCH® 10 Pc. 1/4" Drive 6 Point SAE Impact Socket Set

- Chrome Molybdenum Alloy Steel (Cr-Mo) for Exceptional Strength and Durability
- Surface Drive™ Technology Reduces Fastener Rounding
- Manganese Phosphate Coating to Resist Corrosion
- High Visibility Laser Etched Markings
- Secondary Hard Stamping
- Includes Plastic Socket Rail
- Meets or Exceeds ASME B107.2



Cat. No.	UPC No.	Packaging	Product Weight
84906	099575849060	Carded	1.80 lb

Cat. No.	Description	Cat. No.	Description
84100	1/4" Drive 6 Point Standard Impact Socket 3/16"	84105D	1/4" Drive 6 Point Standard Impact Socket 11/32"
84101	1/4" Drive 6 Point Standard Impact Socket 7/32"	84106	1/4" Drive 6 Point Standard Impact Socket 3/8"
84102	1/4" Drive 6 Point Standard Impact Socket 1/4"	84107	1/4" Drive 6 Point Standard Impact Socket 7/16"
84103	1/4" Drive 6 Point Standard Impact Socket 9/32"	84108	1/4" Drive 6 Point Standard Impact Socket 1/2"
84104	1/4" Drive 6 Point Standard Impact Socket 5/16"	84109	1/4" Drive 6 Point Standard Impact Socket 9/16"

GEARWRENCH® 14 Pc. 1/4" Drive 6 Point Metric Impact Socket Set

- Chrome Molybdenum Alloy Steel (Cr-Mo) for Exceptional Strength and Durability
- Surface Drive™ Technology Reduces Fastener Rounding
- Manganese Phosphate Coating to Resist Corrosion
- High Visibility Laser Etched Markings
- Secondary Hard Stamping
- Includes Plastic Socket Rail
- Meets or Exceeds ASME B107.33M



Cat. No.	UPC No.	Packaging	Product Weight
84907	099575849077	Carded	2.30 lb

Cat. No.	Description	Cat. No.	Description
84111	1/4" Drive 6 Point Standard Impact Socket 4mm	84118	1/4" Drive 6 Point Standard Impact Socket 9mm
84112	1/4" Drive 6 Point Standard Impact Socket 4.5mm	84119	1/4" Drive 6 Point Standard Impact Socket 10mm
84113	1/4" Drive 6 Point Standard Impact Socket 5mm	84120	1/4" Drive 6 Point Standard Impact Socket 11mm
84114	1/4" Drive 6 Point Standard Impact Socket 5.5mm	84121	1/4" Drive 6 Point Standard Impact Socket 12mm
84115	1/4" Drive 6 Point Standard Impact Socket 6mm	84122	1/4" Drive 6 Point Standard Impact Socket 13mm
84116	1/4" Drive 6 Point Standard Impact Socket 7mm	84123	1/4" Drive 6 Point Standard Impact Socket 14mm
84117	1/4" Drive 6 Point Standard Impact Socket 8mm	84124	1/4" Drive 6 Point Standard Impact Socket 15mm

GEARWRENCH® 10 Pc. 1/4" Drive 6 Point SAE Deep Impact Socket Set

- Chrome Molybdenum Alloy Steel (Cr-Mo) for Exceptional Strength and Durability
- Surface Drive™ Technology Reduces Fastener Rounding
- Manganese Phosphate Coating to Resist Corrosion
- High Visibility Laser Etched Markings
- Secondary Hard Stamping
- Includes Plastic Socket Rail
- Meets or Exceeds ASME B107.2



Cat. No.	UPC No.	Packaging	Product Weight
84908	099575849084	Carded	1.15 lb

Cat. No.	Description	Cat. No.	Description
84126	1/4" Drive 6 Point Deep Impact Socket 3/16"	84131	1/4" Drive 6 Point Deep Impact Socket 11/32"
84127	1/4" Drive 6 Point Deep Impact Socket 7/32"	84132	1/4" Drive 6 Point Deep Impact Socket 3/8"
84128	1/4" Drive 6 Point Deep Impact Socket 1/4"	84133	1/4" Drive 6 Point Deep Impact Socket 7/16"
84129	1/4" Drive 6 Point Deep Impact Socket 9/32"	84134	1/4" Drive 6 Point Deep Impact Socket 1/2"
84130	1/4" Drive 6 Point Deep Impact Socket 5/16"	84135	1/4" Drive 6 Point Deep Impact Socket 9/16"

1 / 4 "

4

I M P A C T S O C K E T S

GEARWRENCH® 14 Pc. 1/4" Drive 6 Point Metric Deep Impact Socket Set

- Chrome Molybdenum Alloy Steel (Cr-Mo) for Exceptional Strength and Durability
- Surface Drive™ Technology Reduces Fastener Rounding
- Manganese Phosphate Coating to Resist Corrosion
- High Visibility Laser Etched Markings
- Secondary Hard Stamping
- Includes Plastic Socket Rail
- Meets or Exceeds ASME B107.33M



Cat. No.	UPC No.	Packaging	Product Weight
84909	099575849091	Carded	1.58 lb

Cat. No.	Description	Cat. No.	Description
84137	1/4" Drive 6 Point Deep Impact Socket 4mm	84144	1/4" Drive 6 Point Deep Impact Socket 9mm
84138	1/4" Drive 6 Point Deep Impact Socket 4.5mm	84145	1/4" Drive 6 Point Deep Impact Socket 10mm
84139	1/4" Drive 6 Point Deep Impact Socket 5mm	84146	1/4" Drive 6 Point Deep Impact Socket 11mm
84140	1/4" Drive 6 Point Deep Impact Socket 5.5mm	84147	1/4" Drive 6 Point Deep Impact Socket 12mm
84141	1/4" Drive 6 Point Deep Impact Socket 6mm	84148	1/4" Drive 6 Point Deep Impact Socket 13mm
84142	1/4" Drive 6 Point Deep Impact Socket 7mm	84149	1/4" Drive 6 Point Deep Impact Socket 14mm
84143	1/4" Drive 6 Point Deep Impact Socket 8mm	84150D	1/4" Drive 6 Point Deep Impact Socket 15mm

GEARWRENCH® 6 Pc. 1/4" Drive 6 Point SAE Universal Impact Socket Set

- Chrome Molybdenum Alloy Steel (Cr-Mo) for Exceptional Strength and Durability
- Surface Drive™ Technology Reduces Fastener Rounding
- Manganese Phosphate Coating to Resist Corrosion
- High Visibility Laser Etched Markings



Cat. No.	UPC No.	Packaging	Product Weight
84904	099575849046	Carded	1.10 lb

Cat. No.	Description	Cat. No.	Description
84152	1/4" Drive Universal Impact Socket 1/4"	84155	1/4" Drive Universal Impact Socket 7/16"
84153	1/4" Drive Universal Impact Socket 5/16"	84156	1/4" Drive Universal Impact Socket 1/2"
84154	1/4" Drive Universal Impact Socket 3/8"	84157	1/4" Drive Universal Impact Socket 9/16"

1 / 4 "

4

IMPACT SOCKETS

GEARWRENCH® 12 Pc. 1/4" Drive 6 Point Metric Universal Impact Socket Set

- Chrome Molybdenum Alloy Steel (Cr-Mo) for Exceptional Strength and Durability
- Surface Drive™ Technology Reduces Fastener Rounding
- Manganese Phosphate Coating to Resist Corrosion
- High Visibility Laser Etched Markings



Cat. No.	UPC No.	Packaging	Product Weight
84905	099575849053	Carded	1.43 lb

Cat. No.	Description	Cat. No.	Description
84159	1/4" Drive Universal Impact Socket 5mm	84165	1/4" Drive Universal Impact Socket 10mm
84160	1/4" Drive Universal Impact Socket 5.5mm	84166	1/4" Drive Universal Impact Socket 11mm
84161	1/4" Drive Universal Impact Socket 6mm	84167	1/4" Drive Universal Impact Socket 12mm
84162	1/4" Drive Universal Impact Socket 7mm	84168	1/4" Drive Universal Impact Socket 13mm
84163	1/4" Drive Universal Impact Socket 8mm	84169	1/4" Drive Universal Impact Socket 14mm
84164	1/4" Drive Universal Impact Socket 9mm	84170	1/4" Drive Universal Impact Socket 15mm

GEARWRENCH® 1/4" Drive Impact Extensions

- Chrome Molybdenum Alloy Steel (Cr-Mo) for Exceptional Strength and Long Lasting Durability
- Pin Hole for Use with Pin and O-Ring for Secure Socket Retention
- High Visibility Laser Etched Markings
- Meets or Exceeds ASME B107.2



Cat. No.	UPC No.	Packaging	Male Drive Size	Female Drive Size	Overall Length	Product Weight
84172	099575841729	Carded	1/4"	1/4"	2 in	0.10 lb
84173	099575841736	Carded	1/4"	1/4"	4 in	0.20 lb
84174	099575841743	Carded	1/4"	1/4"	6 in	0.30 lb

GEARWRENCH® 1/4" Drive Impact Drive Adapter

- Chrome Molybdenum Alloy Steel (Cr-Mo) for Exceptional Strength and Long Lasting Durability
- High Visibility Laser Etched Markings
- Meets or Exceeds ASME B107.1



Cat. No.	UPC No.	Packaging	Female Drive Size	Male Drive Size	Dim. A: Drive End	Length	Product Weight
84176	099575841767	Carded	1/4"	3/8"	0.626 in	1.000 in	0.15 lb

1 / 4 "

4

I M P A C T S O C K E T S

GEARWRENCH® 1/4" Drive Impact Universal Joint

- Chrome Molybdenum Alloy Steel (Cr-Mo) for Exceptional Strength and Long Lasting Durability
- Manganese Phosphate Coating to Resist Corrosion
- Meets or Exceeds ASME B107.2



Cat. No.	UPC No.	Packaging	Female Drive Size	Male Drive Size	Dim. A: Drive End	Length	Product Weight
80101	099575801013	Carded	1/4"	1/4"	0.62 in	1.450 in	0.28 lb

GEARWRENCH® 1/4" Drive 6 Point SAE Standard Impact Sockets

- Chrome Molybdenum Alloy Steel (Cr-Mo) for Exceptional Strength and Durability
- Surface Drive™ Technology Reduces Fastener Rounding
- Manganese Phosphate Coating to Resist Corrosion
- High Visibility Laser Etched Markings
- Secondary Hard Stamping
- Meets or Exceeds ASME B107.2

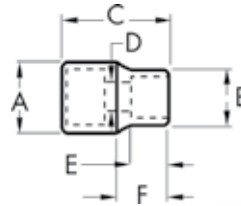

Cat. No.	UPC No.	Packaging	Fastener Size	Dim. A: Drive End	Dim. B: Wrench End	Dim. C: Overall Length	Dim. D: Bolt Clearance	Dim. E: Wrench Depth	Dim. F: Length to Shoulder	Product Weight
84100	099575841002	Carded	3/16 in	0.512 in	0.335 in	0.906 in	0.130 in	0.110 in	0.393 in	0.02 lb
84101	099575841019	Carded	7/32 in	0.512 in	0.374 in	0.906 in	0.130 in	0.125 in	0.393 in	0.04 lb
84102	099575841026	Carded	1/4 in	0.512 in	0.406 in	0.906 in	0.150 in	0.125 in	0.393 in	0.05 lb
84103	099575841033	Carded	9/32 in	0.512 in	0.445 in	0.906 in	0.171 in	0.125 in	0.393 in	0.05 lb
84104	099575841040	Carded	5/16 in	0.512 in	0.492 in	0.906 in	0.171 in	0.125 in	0.393 in	0.05 lb
84105D	099575841057	Carded	11/32 in	0.512 in	0.543 in	0.906 in	0.203 in	0.170 in	0.905 in	0.05 lb
84106	099575841064	Carded	3/8 in	0.512 in	0.591 in	0.906 in	0.281 in	0.219 in	0.905 in	0.06 lb
84107	099575841071	Carded	7/16 in	0.512 in	0.642 in	0.906 in	0.281 in	0.219 in	0.905 in	0.07 lb
84108	099575841088	Carded	1/2 in	0.512 in	0.740 in	0.906 in	0.344 in	0.281 in	0.905 in	0.08 lb
84109	099575841095	Carded	9/16 in	0.512 in	0.740 in	0.906 in	0.406 in	0.281 in	0.905 in	0.09 lb

GEARWRENCH® 1/4" Drive 6 Point Metric Impact Sockets

- Chrome Molybdenum Alloy Steel (Cr-Mo) for Exceptional Strength and Durability
- Surface Drive™ Technology Reduces Fastener Rounding
- Manganese Phosphate Coating to Resist Corrosion
- High Visibility Laser Etched Markings
- Secondary Hard Stamping
- Meets or Exceeds ASME B107.33M

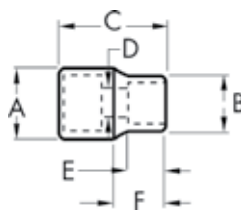

Cat. No.	UPC No.	Packaging	Fastener Size	Dim. A: Drive End	Dim. B: Wrench End	Dim. C: Overall Length	Dim. D: Bolt Clearance	Dim. E: Wrench Depth	Dim. F: Length to Shoulder	Product Weight
84111	099575841118	Carded	4 mm	0.512 in	0.335 in	0.906 in	0.110 in	0.110 in	0.393 in	0.03 lb
84112	099575841125	Carded	4.5 mm	0.512 in	0.335 in	0.906 in	0.110 in	0.110 in	0.393 in	0.04 lb
84113	099575841132	Carded	5 mm	0.512 in	0.346 in	0.906 in	0.125 in	0.110 in	0.393 in	0.04 lb
84114	099575841149	Carded	5.5 mm	0.512 in	0.374 in	0.906 in	0.140 in	0.110 in	0.393 in	0.04 lb
84115	099575841156	Carded	6 mm	0.512 in	0.394 in	0.906 in	0.140 in	0.120 in	0.393 in	0.05 lb
84116	099575841163	Carded	7 mm	0.512 in	0.445 in	0.906 in	0.170 in	0.139 in	0.393 in	0.05 lb
84117	099575841170	Carded	8 mm	0.512 in	0.492 in	0.906 in	0.209 in	0.139 in	0.393 in	0.05 lb
84118	099575841187	Carded	9 mm	0.512 in	0.543 in	0.906 in	0.209 in	0.159 in	0.905 in	0.05 lb
84119	099575841194	Carded	10 mm	0.512 in	0.591 in	0.906 in	0.259 in	0.181 in	0.905 in	0.05 lb
84120	099575841200	Carded	11 mm	0.512 in	0.642 in	0.906 in	0.299 in	0.214 in	0.905 in	0.07 lb
84121	099575841217	Carded	12 mm	0.512 in	0.669 in	0.906 in	0.327 in	0.240 in	0.905 in	0.07 lb
84122	099575841224	Carded	13 mm	0.512 in	0.740 in	0.906 in	0.327 in	0.265 in	0.905 in	0.08 lb
84123	099575841231	Carded	14 mm	0.512 in	0.787 in	0.906 in	0.407 in	0.295 in	0.905 in	0.09 lb
84124	099575841248	Carded	15 mm	0.512 in	0.827 in	0.906 in	0.407 in	0.295 in	0.905 in	0.11 lb

GEARWRENCH® 1/4" Drive 6 Point SAE Deep Impact Sockets

- Chrome Molybdenum Alloy Steel (Cr-Mo) for Exceptional Strength and Durability
- Surface Drive™ Technology Reduces Fastener Rounding
- Manganese Phosphate Coating to Resist Corrosion
- High Visibility Laser Etched Markings
- Secondary Hard Stamping
- Meets or Exceeds ASME B107.2

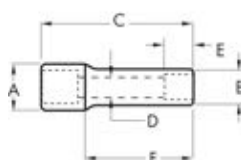

Cat. No.	UPC No.	Packaging	Fastener Size	Dim. A: Drive End	Dim. B: Wrench End	Dim. C: Overall Length	Dim. D: Bolt Clearance	Dim. E: Wrench Depth	Dim. F: Length to Shoulder	Product Weight
84126	099575841262	Carded	3/16 in	0.512 in	0.335 in	1.968 in	0.130 in	0.110 in	0.905 in	0.07 lb
84127	099575841279	Carded	7/32 in	0.512 in	0.374 in	1.968 in	0.130 in	0.125 in	0.905 in	0.08 lb
84128	099575841286	Carded	1/4 in	0.512 in	0.406 in	1.968 in	0.150 in	0.125 in	0.905 in	0.08 lb
84129	099575841293	Carded	9/32 in	0.512 in	0.445 in	1.968 in	0.171 in	0.125 in	0.905 in	0.08 lb
84130	099575841309	Carded	5/16 in	0.512 in	0.492 in	1.968 in	0.171 in	0.125 in	0.905 in	0.08 lb
84131	099575841316	Carded	11/32 in	0.512 in	0.543 in	1.968 in	0.203 in	0.170 in	1.968 in	0.08 lb
84132	099575841323	Carded	3/8 in	0.512 in	0.591 in	1.968 in	0.281 in	0.219 in	1.968 in	0.10 lb
84133	099575841330	Carded	7/16 in	0.512 in	0.642 in	1.968 in	0.281 in	0.219 in	1.968 in	0.12 lb
84134	099575841347	Carded	1/2 in	0.512 in	0.740 in	1.968 in	0.344 in	0.281 in	1.968 in	0.17 lb
84135	099575841354	Carded	9/16 in	0.512 in	0.787 in	1.968 in	0.406 in	0.281 in	1.968 in	0.18 lb

1 / 4 "

4

I M P A C T S O C K E T S

GEARWRENCH® 1/4" Drive 6 Point Metric Deep Impact Sockets

- Chrome Molybdenum Alloy Steel (Cr-Mo) for Exceptional Strength and Durability
- Surface Drive™ Technology Reduces Fastener Rounding
- Manganese Phosphate Coating to Resist Corrosion
- High Visibility Laser Etched Markings
- Secondary Hard Stamping
- Meets or Exceeds ASME B107.33M

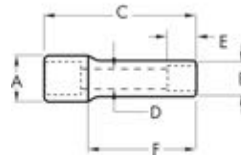

Cat. No.	UPC No.	Packaging	Fastener Size	Dim. A: Drive End	Dim. B: Wrench End	Dim. C: Overall Length	Dim. D: Bolt Clearance	Dim. E: Wrench Depth	Dim. F: Length to Shoulder	Product Weight
84137	099575841378	Carded	4 mm	0.512 in	0.335 in	1.968 in	0.110 in	0.110 in	0.905 in	0.07 lb
84138	099575841385	Carded	4.5 mm	0.512 in	0.335 in	1.968 in	0.110 in	0.110 in	0.905 in	0.07 lb
84139	099575841392	Carded	5 mm	0.512 in	0.335 in	1.968 in	0.125 in	0.110 in	0.905 in	0.08 lb
84140	099575841408	Carded	5.5 mm	0.512 in	0.374 in	1.968 in	0.140 in	0.110 in	0.905 in	0.08 lb
84141	099575841415	Carded	6 mm	0.512 in	0.394 in	1.968 in	0.140 in	0.120 in	0.905 in	0.08 lb
84142	099575841422	Carded	7 mm	0.512 in	0.445 in	1.968 in	0.170 in	0.139 in	0.905 in	0.08 lb
84143	099575841439	Carded	8 mm	0.512 in	0.492 in	1.968 in	0.209 in	0.139 in	0.905 in	0.08 lb
84144	099575841446	Carded	9 mm	0.512 in	0.543 in	1.968 in	0.209 in	0.159 in	1.968 in	0.09 lb
84145	099575841453	Carded	10 mm	0.512 in	0.591 in	1.968 in	0.259 in	0.181 in	1.968 in	0.10 lb
84146	099575841460	Carded	11 mm	0.512 in	0.642 in	1.968 in	0.299 in	0.214 in	1.968 in	0.12 lb
84147	099575841477	Carded	12 mm	0.512 in	0.669 in	1.968 in	0.327 in	0.240 in	1.968 in	0.13 lb
84148	099575841484	Carded	13 mm	0.512 in	0.740 in	1.968 in	0.327 in	0.265 in	1.968 in	0.17 lb
84149	099575841491	Carded	14 mm	0.512 in	0.787 in	1.968 in	0.407 in	0.295 in	1.968 in	0.18 lb
84150D	099575841507	Carded	15 mm	0.512 in	0.827 in	1.968 in	0.407 in	0.295 in	1.968 in	0.19 lb

GEARWRENCH® 1/4" Drive 6 Point SAE Universal Impact Sockets

- Chrome Molybdenum Alloy Steel (Cr-Mo) for Exceptional Strength and Durability
- Surface Drive™ Technology Reduces Fastener Rounding
- Manganese Phosphate Coating to Resist Corrosion
- High Visibility Laser Etched Markings
- Meets or Exceeds ASME B107.2

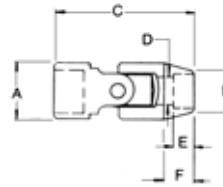

Cat. No.	UPC No.	Packaging	Fastener Size	Dim. A: Drive End	Dim. B: Wrench End	Dim. C: Overall Length	Dim. D: Bolt Clearance	Dim. E: Wrench Depth	Dim. F: Length to Shoulder	Product Weight
84152	099575841521	Carded	1/4 in	0.787 in	0.406 in	1.831 in	0.630 in	0.440 in	1.640 in	0.09 lb
84153	099575841538	Carded	5/16 in	0.787 in	0.492 in	1.831 in	0.630 in	0.520 in	1.640 in	0.11 lb
84154	099575841545	Carded	3/8 in	0.787 in	0.591 in	1.831 in	0.630 in	0.620 in	1.640 in	0.11 lb
84155	099575841552	Carded	7/16 in	0.787 in	0.591 in	1.831 in	0.630 in	0.700 in	1.640 in	0.11 lb
84156	099575841569	Carded	1/2 in	0.787 in	0.591 in	1.831 in	0.630 in	0.750 in	1.640 in	0.11 lb
84157	099575841576	Carded	9/16 in	0.787 in	0.591 in	1.831 in	0.630 in	0.870 in	1.640 in	0.13 lb

1 / 4 "

IMPACT SOCKETS

GEARWRENCH® 1/4" Drive 6 Point Metric Universal Impact Sockets

- Chrome Molybdenum Alloy Steel (Cr-Mo) for Exceptional Strength and Durability
- Surface Drive™ Technology Reduces Fastener Rounding
- Manganese Phosphate Coating to Resist Corrosion
- High Visibility Laser Etched Markings
- Meets or Exceeds ASME B107.33M

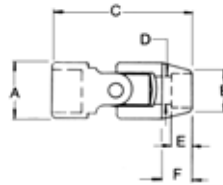

Cat. No.	UPC No.	Packaging	Fastener Size	Dim. A: Drive End	Dim. B: Wrench End	Dim. C: Overall Length	Dim. D: Bolt Clearance	Dim. E: Wrench Depth	Dim. F: Length to Shoulder	Product Weight
84159	099575841590	Carded	5 mm	0.787 in	0.374 in	1.831 in	0.630 in	0.350 in	1.640 in	0.09 lb
84160	099575841606	Carded	5.5 mm	0.787 in	0.374 in	1.831 in	0.630 in	0.390 in	1.640 in	0.09 lb
84161	099575841613	Carded	6 mm	0.787 in	0.394 in	1.831 in	0.630 in	0.440 in	1.640 in	0.10 lb
84162	099575841620	Carded	7 mm	0.787 in	0.453 in	1.831 in	0.630 in	0.480 in	1.640 in	0.10 lb
84163	099575841637	Carded	8 mm	0.787 in	0.492 in	1.831 in	0.630 in	0.520 in	1.640 in	0.10 lb
84164	099575841644	Carded	9 mm	0.787 in	0.551 in	1.831 in	0.630 in	0.590 in	1.640 in	0.10 lb
84165	099575841651	Carded	10 mm	0.787 in	0.591 in	1.831 in	0.630 in	0.620 in	1.640 in	0.11 lb
84166	099575841668	Carded	11 mm	0.787 in	0.650 in	1.831 in	0.630 in	0.670 in	1.640 in	0.11 lb
84167	099575841675	Carded	12 mm	0.787 in	0.661 in	1.831 in	0.630 in	0.710 in	1.640 in	0.11 lb
84168	099575841682	Carded	13 mm	0.787 in	0.740 in	1.831 in	0.630 in	0.750 in	1.640 in	0.11 lb
84169	099575841699	Carded	14 mm	0.787 in	0.780 in	1.831 in	0.630 in	0.800 in	1.640 in	0.12 lb
84170	099575841705	Carded	15 mm	0.787 in	0.819 in	1.831 in	0.630 in	0.870 in	1.640 in	0.13 lb

1 / 4 "

4

I M P A C T S O C K E T S

GEARWRENCH® 44 Pc. 3/8" Drive 6 Point SAE/Metric Std./Deep Impact Socket Set

- Chrome Molybdenum Alloy Steel (Cr-Mo) for Exceptional Strength and Durability
- Surface Drive™ Technology Reduces Fastener Rounding
- Manganese Phosphate Coating to Resist Corrosion
- High Visibility Laser Etched Markings
- Secondary Hard Stamping
- Includes Blow Mold Case
- Meets or Exceeds ASME B107.2/B107.33M



Cat. No.	UPC No.	Packaging	Product Weight
84916	099575849169	Case	10.88 lb

Cat. No.	Description	Cat. No.	Description
84300	3/8" Drive 6 Point Standard Impact Socket 5/16"	84315	3/8" Drive 6 Point Standard Impact Socket 14mm
84301	3/8" Drive 6 Point Standard Impact Socket 3/8"	84316	3/8" Drive 6 Point Standard Impact Socket 15mm
84302	3/8" Drive 6 Point Standard Impact Socket 7/16"	84317	3/8" Drive 6 Point Standard Impact Socket 16mm
84303	3/8" Drive 6 Point Standard Impact Socket 1/2"	84318D	3/8" Drive 6 Point Standard Impact Socket 17mm
84304	3/8" Drive 6 Point Standard Impact Socket 9/16"	84319	3/8" Drive 6 Point Standard Impact Socket 18mm
84305	3/8" Drive 6 Point Standard Impact Socket 5/8"	84320D	3/8" Drive 6 Point Standard Impact Socket 19mm
84306	3/8" Drive 6 Point Standard Impact Socket 11/16"	84331	3/8" Drive 6 Point Deep Impact Socket 8mm
84307	3/8" Drive 6 Point Standard Impact Socket 3/4"	84332	3/8" Drive 6 Point Deep Impact Socket 9mm
84322	3/8" Drive 6 Point Deep Impact Socket 5/16"	84333	3/8" Drive 6 Point Deep Impact Socket 10mm
84323D	3/8" Drive 6 Point Deep Impact Socket 3/8"	84334	3/8" Drive 6 Point Deep Impact Socket 11mm
84324	3/8" Drive 6 Point Deep Impact Socket 7/16"	84335	3/8" Drive 6 Point Deep Impact Socket 12mm
84325D	3/8" Drive 6 Point Deep Impact Socket 1/2"	84336	3/8" Drive 6 Point Deep Impact Socket 13mm
84326	3/8" Drive 6 Point Deep Impact Socket 9/16"	84337	3/8" Drive 6 Point Deep Impact Socket 14mm
84327	3/8" Drive 6 Point Deep Impact Socket 5/8"	84338	3/8" Drive 6 Point Deep Impact Socket 15mm
84328D	3/8" Drive 6 Point Deep Impact Socket 11/16"	84339	3/8" Drive 6 Point Deep Impact Socket 16mm
84329	3/8" Drive 6 Point Deep Impact Socket 3/4"	84340	3/8" Drive 6 Point Deep Impact Socket 17mm
84309	3/8" Drive 6 Point Standard Impact Socket 8mm	84341	3/8" Drive 6 Point Deep Impact Socket 18mm
84310	3/8" Drive 6 Point Standard Impact Socket 9mm	84342	3/8" Drive 6 Point Deep Impact Socket 19mm
84311	3/8" Drive 6 Point Standard Impact Socket 10mm	84343	3/8" Drive 6 Point Deep Impact Socket 21mm
84312	3/8" Drive 6 Point Standard Impact Socket 11mm	84406	3/8" Drive Impact Extension Bar 3"
84313	3/8" Drive 6 Point Standard Impact Socket 12mm	84407	3/8" Drive Impact Extension Bar 6"
84314	3/8" Drive 6 Point Standard Impact Socket 13mm	84405	3/8" Drive Impact Extension Bar 10"

3 / 8 "

4

IMPACT SOCKETS

GEARWRENCH® 8 Pc. 3/8" Drive 6 Point SAE Impact Socket Set

- Chrome Molybdenum Alloy Steel (Cr-Mo) for Exceptional Strength and Durability
- Surface Drive™ Technology Reduces Fastener Rounding
- Manganese Phosphate Coating to Resist Corrosion
- High Visibility Laser Etched Markings
- Secondary Hard Stamping
- Includes Plastic Socket Rail
- Meets or Exceeds ASME B107.2



Cat. No.	UPC No.	Packaging	Product Weight
84910	099575849107	Carded	1.10 lb

Cat. No.	Description	Cat. No.	Description
84300	3/8" Drive 6 Point Standard Impact Socket 5/16"	84304	3/8" Drive 6 Point Standard Impact Socket 9/16"
84301	3/8" Drive 6 Point Standard Impact Socket 3/8"	84305	3/8" Drive 6 Point Standard Impact Socket 5/8"
84302	3/8" Drive 6 Point Standard Impact Socket 7/16"	84306	3/8" Drive 6 Point Standard Impact Socket 11/16"
84303	3/8" Drive 6 Point Standard Impact Socket 1/2"	84307	3/8" Drive 6 Point Standard Impact Socket 3/4"

GEARWRENCH® 12 Pc. 3/8" Drive 6 Point Metric Impact Socket Set

- Chrome Molybdenum Alloy Steel (Cr-Mo) for Exceptional Strength and Durability
- Surface Drive™ Technology Reduces Fastener Rounding
- Manganese Phosphate Coating to Resist Corrosion
- High Visibility Laser Etched Markings
- Secondary Hard Stamping
- Includes Plastic Socket Rail
- Meets or Exceeds ASME B107.33M



Cat. No.	UPC No.	Packaging	Product Weight
84911	099575849114	Carded	1.60 lb

Cat. No.	Description	Cat. No.	Description
84309	3/8" Drive 6 Point Standard Impact Socket 8mm	84315	3/8" Drive 6 Point Standard Impact Socket 14mm
84310	3/8" Drive 6 Point Standard Impact Socket 9mm	84316	3/8" Drive 6 Point Standard Impact Socket 15mm
84311	3/8" Drive 6 Point Standard Impact Socket 10mm	84317	3/8" Drive 6 Point Standard Impact Socket 16mm
84312	3/8" Drive 6 Point Standard Impact Socket 11mm	84318D	3/8" Drive 6 Point Standard Impact Socket 17mm
84313	3/8" Drive 6 Point Standard Impact Socket 12mm	84319	3/8" Drive 6 Point Standard Impact Socket 18mm
84314	3/8" Drive 6 Point Standard Impact Socket 13mm	84320D	3/8" Drive 6 Point Standard Impact Socket 19mm

3 / 8 "

4

I M P A C T S O C K E T S

GEARWRENCH® 8 Pc. 3/8" Drive 6 Point SAE Deep Impact Socket Set

- Chrome Molybdenum Alloy Steel (Cr-Mo) for Exceptional Strength and Durability
- Surface Drive™ Technology Reduces Fastener Rounding
- Manganese Phosphate Coating to Resist Corrosion
- High Visibility Laser Etched Markings
- Secondary Hard Stamping
- Includes Plastic Socket Rail
- Meets or Exceeds ASME B107.2



Cat. No.	UPC No.	Packaging	Product Weight
84915	099575849152	Carded	2.11 lb

Cat. No.	Description	Cat. No.	Description
84322	3/8" Drive 6 Point Deep Impact Socket 5/16"	84326	3/8" Drive 6 Point Deep Impact Socket 9/16"
84323D	3/8" Drive 6 Point Deep Impact Socket 3/8"	84327	3/8" Drive 6 Point Deep Impact Socket 5/8"
84324	3/8" Drive 6 Point Deep Impact Socket 7/16"	84328D	3/8" Drive 6 Point Deep Impact Socket 11/16"
84325D	3/8" Drive 6 Point Deep Impact Socket 1/2"	84329	3/8" Drive 6 Point Deep Impact Socket 3/4"

GEARWRENCH® 13 Pc. 3/8" Drive 6 Point Metric Deep Impact Socket Set

- Chrome Molybdenum Alloy Steel (Cr-Mo) for Exceptional Strength and Durability
- Surface Drive™ Technology Reduces Fastener Rounding
- Manganese Phosphate Coating to Resist Corrosion
- High Visibility Laser Etched Markings
- Secondary Hard Stamping
- Includes Plastic Socket Rail
- Meets or Exceeds ASME B107.33M



Cat. No.	UPC No.	Packaging	Product Weight
84914	099575849145	Carded	3.58 lb

Cat. No.	Description	Cat. No.	Description
84331	3/8" Drive 6 Point Deep Impact Socket 8mm	84338	3/8" Drive 6 Point Deep Impact Socket 15mm
84332	3/8" Drive 6 Point Deep Impact Socket 9mm	84339	3/8" Drive 6 Point Deep Impact Socket 16mm
84333	3/8" Drive 6 Point Deep Impact Socket 10mm	84340	3/8" Drive 6 Point Deep Impact Socket 17mm
84334	3/8" Drive 6 Point Deep Impact Socket 11mm	84341	3/8" Drive 6 Point Deep Impact Socket 18mm
84335	3/8" Drive 6 Point Deep Impact Socket 12mm	84342	3/8" Drive 6 Point Deep Impact Socket 19mm
84336	3/8" Drive 6 Point Deep Impact Socket 13mm	84343	3/8" Drive 6 Point Deep Impact Socket 21mm
84337	3/8" Drive 6 Point Deep Impact Socket 14mm		

3 / 8 " 4 IMPACT SOCKETS

GEARWRENCH® 7 Pc. 3/8" Drive SAE Impact Hex Bit Socket Set

- Chrome Molybdenum Alloy Steel (Cr-Mo) for Exceptional Strength and Durability
- Pin Hole for Use with Pin and O-Ring for Secure Socket Retention
- Manganese Phosphate Coating to Resist Corrosion
- High Visibility Laser Etched Markings
- Secondary Hard Stamping
- Includes Plastic Socket Rail
- Meets or Exceeds ASME B107.2



Cat. No.	UPC No.	Packaging	Product Weight
84913	099575849138	Carded	1.50 lb

Cat. No.	Description	Cat. No.	Description
84397	3/8" Drive Impact Hex Socket 3/16"	84401	3/8" Drive Impact Hex Socket 3/8"
84398	3/8" Drive Impact Hex Socket 7/32"	84402	3/8" Drive Impact Hex Socket 7/16"
84399	3/8" Drive Impact Hex Socket 1/4"	84403	3/8" Drive Impact Hex Socket 1/2"
84400D	3/8" Drive Impact Hex Socket 5/16"		

GEARWRENCH® 7 Pc. 3/8" Drive Metric Impact Hex Bit Socket Set

- Chrome Molybdenum Alloy Steel (Cr-Mo) for Exceptional Strength and Durability
- Pin Hole for Use with Pin and O-Ring for Secure Socket Retention
- Manganese Phosphate Coating to Resist Corrosion
- High Visibility Laser Etched Markings
- Secondary Hard Stamping
- Includes Plastic Socket Rail
- Meets or Exceeds ASME B107.33M



Cat. No.	UPC No.	Packaging	Product Weight
84912	099575849121	Carded	1.50 lb

Cat. No.	Description	Cat. No.	Description
84389	3/8" Drive Impact Hex Socket 4mm	84393	3/8" Drive Impact Hex Socket 8mm
84390	3/8" Drive Impact Hex Socket 5mm	84394	3/8" Drive Impact Hex Socket 10mm
84391	3/8" Drive Impact Hex Socket 6mm	84395	3/8" Drive Impact Hex Socket 12mm
84392	3/8" Drive Impact Hex Socket 7mm		

3 / 8 "

4

I M P A C T S O C K E T S

GEARWRENCH® 8 Pc. 3/8" Drive 6 Point SAE Impact Universal Socket Set

- Chrome Molybdenum Alloy Steel (Cr-Mo) for Exceptional Strength and Durability
- Surface Drive™ Technology Reduces Fastener Rounding
- Manganese Phosphate Coating to Resist Corrosion
- High Visibility Laser Etched Markings



Cat. No.	UPC No.	Packaging	Product Weight
84917	099575849176	Case	5.40 lb

Cat. No.	Description	Cat. No.	Description
84345D	3/8" Drive Universal Impact Socket 5/16"	84349	3/8" Drive Universal Impact Socket 9/16"
84346	3/8" Drive Universal Impact Socket 3/8"	84350	3/8" Drive Universal Impact Socket 5/8"
84347	3/8" Drive Universal Impact Socket 7/16"	84351	3/8" Drive Universal Impact Socket 11/16"
84348	3/8" Drive Universal Impact Socket 1/2"	84352	3/8" Drive Universal Impact Socket 3/4"

GEARWRENCH® 15 Pc. 3/8" Drive 6 Point Metric Impact Universal Socket Set

- Chrome Molybdenum Alloy Steel (Cr-Mo) for Exceptional Strength and Durability
- Surface Drive™ Technology Reduces Fastener Rounding
- Manganese Phosphate Coating to Resist Corrosion
- High Visibility Laser Etched Markings



Cat. No.	UPC No.	Packaging	Product Weight
84918	099575849183	Case	8.22 lb

Cat. No.	Description	Cat. No.	Description
84354	3/8" Drive Universal Impact Socket 8mm	84362	3/8" Drive Universal Impact Socket 16mm
84355	3/8" Drive Universal Impact Socket 9mm	84363	3/8" Drive Universal Impact Socket 17mm
84356	3/8" Drive Universal Impact Socket 10mm	84364	3/8" Drive Universal Impact Socket 18mm
84357	3/8" Drive Universal Impact Socket 11mm	84365	3/8" Drive Universal Impact Socket 19mm
84358	3/8" Drive Universal Impact Socket 12mm	84366	3/8" Drive Universal Impact Socket 20mm
84359	3/8" Drive Universal Impact Socket 13mm	84367	3/8" Drive Universal Impact Socket 21mm
84360	3/8" Drive Universal Impact Socket 14mm	84368	3/8" Drive Universal Impact Socket 22mm
84361	3/8" Drive Universal Impact Socket 15mm		

3 / 8 " 4 IMPACT SOCKETS

GEARWRENCH® 3/8" Drive Impact Extensions

- Chrome Molybdenum Alloy Steel (Cr-Mo) for Exceptional Strength and Long Lasting Durability
- Pin Hole for Use with Pin and O-Ring for Secure Socket Retention
- High Visibility Laser Etched Markings
- Meets or Exceeds ASME B107.2



Cat. No.	UPC No.	Packaging	Male Drive Size	Female Drive Size	Overall Length	Product Weight
84406	099575844065	Carded	3/8"	3/8"	3 in	0.18 lb
84407	099575844072	Carded	3/8"	3/8"	6 in	0.34 lb
84405	099575844058	Carded	3/8"	3/8"	10 in	0.53 lb

GEARWRENCH® 3/8" Drive Impact Drive Adapter

- Chrome Molybdenum Alloy Steel (Cr-Mo) for Exceptional Strength and Long Lasting Durability
- Manganese Phosphate Coating to Resist Corrosion
- Meets or Exceeds ASME B107.1



Cat. No.	UPC No.	Packaging	Female Drive Size	Male Drive Size	Dim. A: Drive End	Length	Product Weight
84408	099575844089	Carded	3/8"	1/2"	0.87 in	1.500 in	0.13 lb

GEARWRENCH® 3/8" Drive Impact Universal Joint

- Chrome Molybdenum Alloy Steel (Cr-Mo) for Exceptional Strength and Long Lasting Durability
- Manganese Phosphate Coating to Resist Corrosion
- Meets or Exceeds ASME B107.2



Cat. No.	UPC No.	Packaging	Female Drive Size	Male Drive Size	Dim. A: Drive End	Length	Product Weight
80548	099575805486	Carded	3/8"	3/8"	0.95 in	2.090 in	0.22 lb

3 / 8 "

4

I M P A C T S O C K E T S

GEARWRENCH® 3/8" Drive 6 Point SAE Impact Sockets

- Chrome Molybdenum Alloy Steel (Cr-Mo) for Exceptional Strength and Durability
- Surface Drive™ Technology Reduces Fastener Rounding
- Manganese Phosphate Coating to Resist Corrosion
- High Visibility Laser Etched Markings
- Secondary Hard Stamping
- Meets or Exceeds ASME B107.2

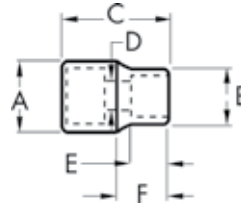

Cat. No.	UPC No.	Packaging	Fastener Size	Dim. A: Drive End	Dim. B: Wrench End	Dim. C: Overall Length	Dim. D: Bolt Clearance	Dim. E: Wrench Depth	Dim. F: Length to Shoulder	Product Weight
84300	099575843006	Carded	5/16 in	0.748 in	0.496 in	1.161 in	0.171 in	0.102 in	0.511 in	0.07 lb
84301	099575843013	Carded	3/8 in	0.748 in	0.575 in	1.161 in	0.281 in	0.117 in	0.511 in	0.08 lb
84302	099575843020	Carded	7/16 in	0.748 in	0.669 in	1.161 in	0.281 in	0.203 in	0.511 in	0.09 lb
84303	099575843037	Carded	1/2 in	0.787 in	0.787 in	1.161 in	0.344 in	0.209 in	1.161 in	0.11 lb
84304	099575843044	Carded	9/16 in	0.827 in	0.827 in	1.161 in	0.406 in	0.249 in	1.161 in	0.13 lb
84305	099575843051	Carded	5/8 in	0.906 in	0.906 in	1.181 in	0.469 in	0.281 in	1.181 in	0.16 lb
84306	099575843068	Carded	11/16 in	0.945 in	0.945 in	1.181 in	0.469 in	0.318 in	1.181 in	0.16 lb
84307	099575843075	Carded	3/4 in	1.024 in	1.024 in	1.181 in	0.531 in	0.356 in	1.181 in	0.17 lb

GEARWRENCH® 3/8" Drive 6 Point Metric Impact Sockets

- Chrome Molybdenum Alloy Steel (Cr-Mo) for Exceptional Strength and Durability
- Surface Drive™ Technology Reduces Fastener Rounding
- Manganese Phosphate Coating to Resist Corrosion
- High Visibility Laser Etched Markings
- Secondary Hard Stamping
- Meets or Exceeds ASME B107.33M

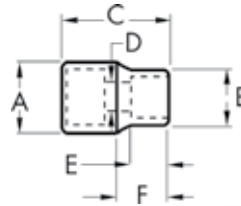

Cat. No.	UPC No.	Packaging	Fastener Size	Dim. A: Drive End	Dim. B: Wrench End	Dim. C: Overall Length	Dim. D: Bolt Clearance	Dim. E: Wrench Depth	Dim. F: Length to Shoulder	Product Weight
84309	099575843099	Carded	8 mm	0.748 in	0.500 in	1.161 in	0.209 in	0.139 in	0.511 in	0.08 lb
84310	099575843105	Carded	9 mm	0.748 in	0.551 in	1.161 in	0.209 in	0.159 in	0.511 in	0.08 lb
84311	099575843112	Carded	10 mm	0.748 in	0.598 in	1.161 in	0.259 in	0.181 in	0.511 in	0.08 lb
84312	099575843129	Carded	11 mm	0.748 in	0.669 in	1.161 in	0.299 in	0.214 in	0.511 in	0.09 lb
84313	099575843136	Carded	12 mm	0.748 in	0.748 in	1.161 in	0.327 in	0.240 in	1.161 in	0.09 lb
84314	099575843143	Carded	13 mm	0.787 in	0.787 in	1.161 in	0.327 in	0.265 in	1.161 in	0.10 lb
84315	099575843150	Carded	14 mm	0.827 in	0.827 in	1.161 in	0.407 in	0.328 in	1.161 in	0.13 lb
84316	099575843167	Carded	15 mm	0.866 in	0.866 in	1.161 in	0.407 in	0.328 in	1.161 in	0.13 lb
84317	099575843174	Carded	16 mm	0.906 in	0.906 in	1.181 in	0.459 in	0.375 in	1.181 in	0.16 lb
84318D	099575843181	Carded	17 mm	0.945 in	0.945 in	1.181 in	0.486 in	0.375 in	1.181 in	0.16 lb
84319	099575843198	Carded	18 mm	0.984 in	0.984 in	1.181 in	0.486 in	0.399 in	1.181 in	0.16 lb
84320D	099575843204	Carded	19 mm	1.024 in	1.024 in	1.181 in	0.531 in	0.433 in	1.181 in	0.17 lb

3 / 8 "

4

IMPACT SOCKETS

GEARWRENCH® 3/8" Drive 6 Point SAE Deep Impact Sockets

- Chrome Molybdenum Alloy Steel (Cr-Mo) for Exceptional Strength and Durability
- Surface Drive™ Technology Reduces Fastener Rounding
- Manganese Phosphate Coating to Resist Corrosion
- High Visibility Laser Etched Markings
- Secondary Hard Stamping
- Meets or Exceeds ASME B107.2

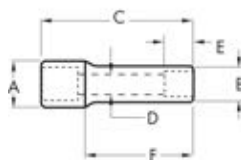

Cat. No.	UPC No.	Packaging	Fastener Size	Dim. A: Drive End	Dim. B: Wrench End	Dim. C: Overall Length	Dim. D: Bolt Clearance	Dim. E: Wrench Depth	Dim. F: Length to Shoulder	Product Weight
84322	099575843228	Carded	5/16 in	0.748 in	0.496 in	2.520 in	0.171 in	0.102 in	0.511 in	0.22 lb
84323D	099575843235	Carded	3/8 in	0.748 in	0.575 in	2.520 in	0.281 in	0.117 in	0.511 in	0.22 lb
84324	099575843242	Carded	7/16 in	0.748 in	0.673 in	2.520 in	0.281 in	0.203 in	0.511 in	0.22 lb
84325D	099575843259	Carded	1/2 in	0.787 in	0.787 in	2.520 in	0.344 in	0.209 in	2.519 in	0.22 lb
84326	099575843266	Carded	9/16 in	0.827 in	0.827 in	2.520 in	0.406 in	0.249 in	2.519 in	0.24 lb
84327	099575843273	Carded	5/8 in	0.906 in	0.906 in	2.520 in	0.469 in	0.281 in	2.519 in	0.26 lb
84328D	099575843280	Carded	11/16 in	0.906 in	0.906 in	2.520 in	0.469 in	0.318 in	2.519 in	0.28 lb
84329	099575843297	Carded	3/4 in	0.906 in	0.906 in	2.520 in	0.531 in	0.356 in	2.519 in	0.32 lb

GEARWRENCH® 3/8" Drive 6 Point Metric Deep Impact Sockets

- Chrome Molybdenum Alloy Steel (Cr-Mo) for Exceptional Strength and Durability
- Surface Drive™ Technology Reduces Fastener Rounding
- Manganese Phosphate Coating to Resist Corrosion
- High Visibility Laser Etched Markings
- Secondary Hard Stamping
- Meets or Exceeds ASME B107.33M

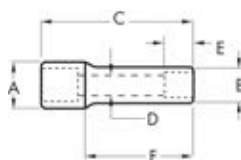

Cat. No.	UPC No.	Packaging	Fastener Size	Dim. A: Drive End	Dim. B: Wrench End	Dim. C: Overall Length	Dim. D: Bolt Clearance	Dim. E: Wrench Depth	Dim. F: Length to Shoulder	Product Weight
84331	099575843310	Carded	8 mm	0.748 in	0.598 in	2.520 in	0.209 in	0.139 in	0.511 in	0.22 lb
84332	099575843327	Carded	9 mm	0.748 in	0.551 in	2.520 in	0.209 in	0.159 in	0.511 in	0.22 lb
84333	099575843334	Carded	10 mm	0.748 in	0.598 in	2.520 in	0.259 in	0.181 in	0.511 in	0.22 lb
84334	099575843341	Carded	11 mm	0.748 in	0.669 in	2.520 in	0.299 in	0.214 in	0.511 in	0.22 lb
84335	099575843358	Carded	12 mm	0.748 in	0.748 in	2.520 in	0.327 in	0.240 in	2.519 in	0.24 lb
84336	099575843365	Carded	13 mm	0.787 in	0.787 in	2.520 in	0.327 in	0.265 in	2.519 in	0.24 lb
84337	099575843372	Carded	14 mm	0.827 in	0.827 in	2.520 in	0.407 in	0.328 in	2.519 in	0.24 lb
84338	099575843389	Carded	15 mm	0.866 in	0.866 in	2.520 in	0.407 in	0.328 in	2.519 in	0.26 lb
84339	099575843396	Carded	16 mm	0.906 in	0.906 in	2.520 in	0.459 in	0.375 in	2.519 in	0.27 lb
84340	099575843402	Carded	17 mm	0.945 in	0.945 in	2.520 in	0.486 in	0.375 in	2.519 in	0.29 lb
84341	099575843419	Carded	18 mm	0.984 in	0.984 in	2.520 in	0.486 in	0.399 in	2.519 in	0.32 lb
84342	099575843426	Carded	19 mm	1.024 in	1.024 in	2.520 in	0.531 in	0.433 in	2.519 in	0.32 lb
84343	099575843433	Carded	21 mm	1.102 in	1.102 in	2.520 in	0.590 in	0.460 in	2.519 in	0.39 lb

3 / 8 "

4

I M P A C T S O C K E T S

GEARWRENCH® 3/8" Drive SAE Impact Hex Bit Sockets

- Chrome Molybdenum Alloy Steel (Cr-Mo) for Exceptional Strength and Durability
- Pin Hole for Use with Pin and O-Ring for Secure Socket Retention
- Manganese Phosphate Coating to Resist Corrosion
- High Visibility Laser Etched Markings
- Secondary Hard Stamping
- Meets or Exceeds ASME B107.2

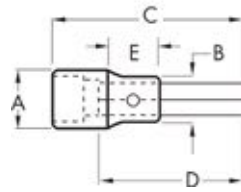

Cat. No.	UPC No.	Packaging	Fastener Size	Dim. A: Drive End	Dim. B: Nose Diameter	Dim. C: Overall Length	Dim. D: Bit Length	Dim. E: Length to Shoulder	Product Weight
84397	099575843976	Carded	3/16 in	0.83 in	0.19 in	1.97 in	0.22 in	0.59 in	0.14 lb
84398	099575843983	Carded	7/32 in	0.83 in	0.22 in	1.97 in	0.25 in	0.59 in	0.14 lb
84399	099575843990	Carded	1/4 in	0.83 in	0.25 in	1.97 in	0.29 in	0.58 in	0.15 lb
84400D	099575844003	Carded	5/16 in	0.83 in	0.31 in	1.97 in	0.36 in	0.59 in	0.16 lb
84401	099575844010	Carded	3/8 in	0.83 in	0.38 in	1.97 in	0.43 in	0.78 in	0.18 lb
84402	099575844027	Carded	7/16 in	0.83 in	0.44 in	1.97 in	0.51 in	0.80 in	0.20 lb
84403	099575844034	Carded	1/2 in	0.83 in	0.50 in	1.97 in	0.58 in	0.78 in	0.22 lb

GEARWRENCH® 3/8" Drive Metric Impact Hex Bit Sockets

- Chrome Molybdenum Alloy Steel (Cr-Mo) for Exceptional Strength and Durability
- Pin Hole for Use with Pin and O-Ring for Secure Socket Retention
- Manganese Phosphate Coating to Resist Corrosion
- High Visibility Laser Etched Markings
- Secondary Hard Stamping
- Meets or Exceeds ASME B107.33M

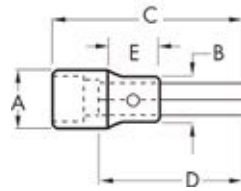

Cat. No.	UPC No.	Packaging	Fastener Size	Dim. A: Drive End	Dim. B: Nose Diameter	Dim. C: Overall Length	Dim. D: Bit Length	Dim. E: Length to Shoulder	Product Weight
84389	099575843891	Carded	4 mm	0.83 in	0.16 in	1.97 in	0.18 in	0.57 in	0.14 lb
84390	099575843907	Carded	5 mm	0.83 in	0.20 in	1.97 in	0.23 in	0.58 in	0.14 lb
84391	099575843914	Carded	6 mm	0.83 in	0.24 in	1.97 in	0.27 in	0.60 in	0.15 lb
84392	099575843921	Carded	7 mm	0.83 in	0.28 in	1.97 in	0.32 in	0.60 in	0.15 lb
84393	099575843938	Carded	8 mm	0.83 in	0.31 in	1.97 in	0.36 in	0.58 in	0.16 lb
84394	099575843945	Carded	10 mm	0.83 in	0.39 in	1.97 in	0.45 in	0.79 in	0.20 lb
84395	099575843952	Carded	12 mm	0.83 in	0.47 in	1.97 in	0.54 in	0.78 in	0.30 lb

3 / 8 "

4

IMPACT SOCKETS

GEARWRENCH® 3/8" Drive 6 Point SAE Universal Impact Sockets

- Chrome Molybdenum Alloy Steel (Cr-Mo) for Exceptional Strength and Durability
- Surface Drive™ Technology Reduces Fastener Rounding
- Manganese Phosphate Coating to Resist Corrosion
- High Visibility Laser Etched Markings
- Meets or Exceeds ASME B107.2

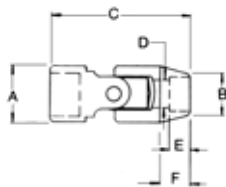

Cat. No.	UPC No.	Packaging	Fastener Size	Dim. A: Drive End	Dim. B: Wrench End	Dim. C: Overall Length	Dim. D: Bolt Clearance	Dim. E: Wrench Depth	Dim. F: Length to Shoulder	Product Weight
84345D	099575843457	Carded	5/16 in	0.945 in	0.551 in	2.047 in	0.940 in	0.550 in	2.130 in	0.23 lb
84346	099575843464	Carded	3/8 in	0.945 in	0.709 in	2.047 in	0.940 in	0.670 in	2.130 in	0.23 lb
84347	099575843471	Carded	7/16 in	0.945 in	0.756 in	2.047 in	0.940 in	0.740 in	2.130 in	0.25 lb
84348	099575843488	Carded	1/2 in	0.945 in	0.866 in	2.047 in	0.940 in	0.780 in	2.130 in	0.25 lb
84349	099575843495	Carded	9/16 in	0.945 in	0.866 in	2.047 in	0.940 in	0.870 in	2.130 in	0.27 lb
84350	099575843501	Carded	5/8 in	0.945 in	1.024 in	2.047 in	0.940 in	0.950 in	2.130 in	0.28 lb
84351	099575843518	Carded	11/16 in	0.945 in	1.055 in	2.047 in	0.940 in	1.060 in	2.130 in	0.29 lb
84352	099575843525	Carded	3/4 in	0.945 in	1.102 in	2.047 in	0.940 in	1.100 in	2.130 in	0.29 lb

GEARWRENCH® 3/8" Drive 6 Point Metric Impact Universal Sockets

- Chrome Molybdenum Alloy Steel (Cr-Mo) for Exceptional Strength and Durability
- Surface Drive™ Technology Reduces Fastener Rounding
- Manganese Phosphate Coating to Resist Corrosion
- High Visibility Laser Etched Markings
- Meets or Exceeds ASME B107.2

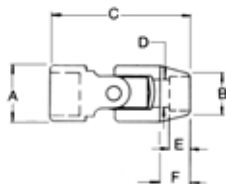

Cat. No.	UPC No.	Packaging	Fastener Size	Dim. A: Drive End	Dim. B: Wrench End	Dim. C: Overall Length	Dim. D: Bolt Clearance	Dim. E: Wrench Depth	Dim. F: Length to Shoulder	Product Weight
84354	099575843549	Carded	8 mm	0.945 in	0.551 in	2.047 in	0.940 in	0.550 in	2.130 in	0.23 lb
84355	099575843556	Carded	9 mm	0.945 in	0.638 in	2.047 in	0.940 in	0.590 in	2.130 in	0.24 lb
84356	099575843563	Carded	10 mm	0.945 in	0.709 in	2.047 in	0.940 in	0.670 in	2.130 in	0.25 lb
84357	099575843570	Carded	11 mm	0.945 in	0.756 in	2.047 in	0.940 in	0.710 in	2.130 in	0.25 lb
84358	099575843587	Carded	12 mm	0.945 in	0.756 in	2.047 in	0.940 in	0.740 in	2.130 in	0.25 lb
84359	099575843594	Carded	13 mm	0.945 in	0.866 in	2.047 in	0.940 in	0.780 in	2.130 in	0.25 lb
84360	099575843600	Carded	14 mm	0.945 in	0.866 in	2.047 in	0.940 in	0.870 in	2.130 in	0.27 lb
84361	099575843617	Carded	15 mm	0.945 in	0.866 in	2.047 in	0.940 in	0.870 in	2.130 in	0.27 lb
84362	099575843624	Carded	16 mm	0.945 in	1.024 in	2.047 in	0.940 in	0.950 in	2.130 in	0.28 lb
84363	099575843631	Carded	17 mm	0.945 in	1.055 in	2.047 in	0.940 in	1.020 in	2.130 in	0.30 lb
84364	099575843648	Carded	18 mm	0.945 in	1.063 in	2.047 in	0.940 in	1.060 in	2.130 in	0.29 lb
84365	099575843655	Carded	19 mm	0.945 in	1.102 in	2.047 in	0.940 in	1.100 in	2.130 in	0.30 lb
84366	099575843662	Carded	20 mm	0.945 in	1.181 in	2.047 in	0.940 in	1.180 in	2.130 in	0.32 lb
84367	099575843679	Carded	21 mm	0.945 in	1.260 in	2.047 in	0.940 in	1.250 in	2.130 in	0.33 lb
84368	099575843686	Carded	22 mm	0.945 in	1.260 in	2.047 in	0.940 in	1.250 in	2.130 in	0.32 lb

GEARWRENCH® 19 Pc. 1/2" Drive 6 Point SAE Impact Socket Set

- Chrome Molybdenum Alloy Steel (Cr-Mo) for Exceptional Strength and Durability
- Surface Drive™ Technology Reduces Fastener Rounding
- Manganese Phosphate Coating to Resist Corrosion
- High Visibility Laser Etched Markings
- Secondary Hard Stamping
- Includes Blow Mold Case
- Meets or Exceeds ASME B107.2



Cat. No.	UPC No.	Packaging	Product Weight
84932	099575849329	Case	10.24 lb

Cat. No.	Description	Cat. No.	Description
84500D	1/2" Drive 6 Point Standard Impact Socket 3/8"	84510D	1/2" Drive 6 Point Standard Impact Socket 1"
84501	1/2" Drive 6 Point Standard Impact Socket 7/16"	84511D	1/2" Drive 6 Point Standard Impact Socket 1-1/16"
84502	1/2" Drive 6 Point Standard Impact Socket 1/2"	84512D	1/2" Drive 6 Point Standard Impact Socket 1-1/8"
84503	1/2" Drive 6 Point Standard Impact Socket 9/16"	84513D	1/2" Drive 6 Point Standard Impact Socket 1-3/16"
84504D	1/2" Drive 6 Point Standard Impact Socket 5/8"	84514D	1/2" Drive 6 Point Standard Impact Socket 1-1/4"
84505D	1/2" Drive 6 Point Standard Impact Socket 11/16"	84515D	1/2" Drive 6 Point Standard Impact Socket 1-5/16"
84506D	1/2" Drive 6 Point Standard Impact Socket 3/4"	84516D	1/2" Drive 6 Point Standard Impact Socket 1-3/8"
84507D	1/2" Drive 6 Point Standard Impact Socket 13/16"	84517D	1/2" Drive 6 Point Standard Impact Socket 1-7/16"
84508D	1/2" Drive 6 Point Standard Impact Socket 7/8"	84518D	1/2" Drive 6 Point Standard Impact Socket 1-1/2"
84509D	1/2" Drive 6 Point Standard Impact Socket 15/16"		

GEARWRENCH® 12 Pc. 1/2" Drive 6 Point SAE Impact Socket Set

- Chrome Molybdenum Alloy Steel (Cr-Mo) for Exceptional Strength and Durability
- Surface Drive™ Technology Reduces Fastener Rounding
- Manganese Phosphate Coating to Resist Corrosion
- High Visibility Laser Etched Markings
- Secondary Hard Stamping
- Includes Blow Mold Case
- Meets or Exceeds ASME B107.2



Cat. No.	UPC No.	Packaging	Product Weight
84931	099575849312	Case	3.88 lb

Cat. No.	Description	Cat. No.	Description
84500D	1/2" Drive 6 Point Standard Impact Socket 3/8"	84506D	1/2" Drive 6 Point Standard Impact Socket 3/4"
84501	1/2" Drive 6 Point Standard Impact Socket 7/16"	84507D	1/2" Drive 6 Point Standard Impact Socket 13/16"
84502	1/2" Drive 6 Point Standard Impact Socket 1/2"	84508D	1/2" Drive 6 Point Standard Impact Socket 7/8"
84503	1/2" Drive 6 Point Standard Impact Socket 9/16"	84509D	1/2" Drive 6 Point Standard Impact Socket 15/16"
84504D	1/2" Drive 6 Point Standard Impact Socket 5/8"	84510D	1/2" Drive 6 Point Standard Impact Socket 1"
84505D	1/2" Drive 6 Point Standard Impact Socket 11/16"	84511D	1/2" Drive 6 Point Standard Impact Socket 1-1/16"

1 / 2 "

4

IMPACT SOCKETS

GEARWRENCH® 25 Pc. 1/2" Drive 6 Point Metric Impact Socket Set

- Chrome Molybdenum Alloy Steel (Cr-Mo) for Exceptional Strength and Durability
- Surface Drive™ Technology Reduces Fastener Rounding
- Manganese Phosphate Coating to Resist Corrosion
- High Visibility Laser Etched Markings
- Secondary Hard Stamping
- Includes Blow Mold Case
- Meets or Exceeds ASME B107.33M



Cat. No.	UPC No.	Packaging	Product Weight
84933	099575849336	Case	11.14 lb

Cat. No.	Description	Cat. No.	Description
84520	1/2" Drive 6 Point Standard Impact Socket 8mm	84533	1/2" Drive 6 Point Standard Impact Socket 21mm
84521D	1/2" Drive 6 Point Standard Impact Socket 9mm	84534	1/2" Drive 6 Point Standard Impact Socket 22mm
84522D	1/2" Drive 6 Point Standard Impact Socket 10mm	84535	1/2" Drive 6 Point Standard Impact Socket 23mm
84523D	1/2" Drive 6 Point Standard Impact Socket 11mm	84536	1/2" Drive 6 Point Standard Impact Socket 24mm
84524D	1/2" Drive 6 Point Standard Impact Socket 12mm	84537	1/2" Drive 6 Point Standard Impact Socket 25mm
84525D	1/2" Drive 6 Point Standard Impact Socket 13mm	84538	1/2" Drive 6 Point Standard Impact Socket 26mm
84526D	1/2" Drive 6 Point Standard Impact Socket 14mm	84539	1/2" Drive 6 Point Standard Impact Socket 28mm
84527D	1/2" Drive 6 Point Standard Impact Socket 15mm	84540	1/2" Drive 6 Point Standard Impact Socket 29mm
84528D	1/2" Drive 6 Point Standard Impact Socket 16mm	84541	1/2" Drive 6 Point Standard Impact Socket 30mm
84529D	1/2" Drive 6 Point Standard Impact Socket 17mm	84542	1/2" Drive 6 Point Standard Impact Socket 31mm
84530D	1/2" Drive 6 Point Standard Impact Socket 18mm	84543	1/2" Drive 6 Point Standard Impact Socket 32mm
84531	1/2" Drive 6 Point Standard Impact Socket 19mm	84544	1/2" Drive 6 Point Standard Impact Socket 36mm
84532	1/2" Drive 6 Point Standard Impact Socket 20mm		

GEARWRENCH® 12 Pc. 1/2" Drive 6 Point Metric Impact Socket Set

- Chrome Molybdenum Alloy Steel (Cr-Mo) for Exceptional Strength and Durability
- Surface Drive™ Technology Reduces Fastener Rounding
- Manganese Phosphate Coating to Resist Corrosion
- High Visibility Laser Etched Markings
- Secondary Hard Stamping
- Includes Blow Mold Case
- Meets or Exceeds ASME B107.33M



Cat. No.	UPC No.	Packaging	Product Weight
84930	099575849305	Case	2.98 lb

Cat. No.	Description	Cat. No.	Description
84520	1/2" Drive 6 Point Standard Impact Socket 8mm	84526D	1/2" Drive 6 Point Standard Impact Socket 14mm
84521D	1/2" Drive 6 Point Standard Impact Socket 9mm	84527D	1/2" Drive 6 Point Standard Impact Socket 15mm
84522D	1/2" Drive 6 Point Standard Impact Socket 10mm	84528D	1/2" Drive 6 Point Standard Impact Socket 16mm
84523D	1/2" Drive 6 Point Standard Impact Socket 11mm	84529D	1/2" Drive 6 Point Standard Impact Socket 17mm
84524D	1/2" Drive 6 Point Standard Impact Socket 12mm	84530D	1/2" Drive 6 Point Standard Impact Socket 18mm
84525D	1/2" Drive 6 Point Standard Impact Socket 13mm	84531	1/2" Drive 6 Point Standard Impact Socket 19mm

GEARWRENCH® 19 Pc. 1/2" Drive 6 Point SAE Deep Impact Socket Set

- Chrome Molybdenum Alloy Steel (Cr-Mo) for Exceptional Strength and Durability
- Surface Drive™ Technology Reduces Fastener Rounding
- Manganese Phosphate Coating to Resist Corrosion
- High Visibility Laser Etched Markings
- Secondary Hard Stamping
- Includes Blow Mold Case
- Meets or Exceeds ASME B107.2



Cat. No.	UPC No.	Packaging	Product Weight
84934	099575849343	Case	14.91 lb

Cat. No.	Description	Cat. No.	Description
84546	1/2" Drive 6 Point Deep Impact Socket 3/8"	84556	1/2" Drive 6 Point Deep Impact Socket 1"
84547	1/2" Drive 6 Point Deep Impact Socket 7/16"	84557	1/2" Drive 6 Point Deep Impact Socket 1-1/16"
84548	1/2" Drive 6 Point Deep Impact Socket 1/2"	84558	1/2" Drive 6 Point Deep Impact Socket 1-1/8"
84549	1/2" Drive 6 Point Deep Impact Socket 9/16"	84560	1/2" Drive 6 Point Deep Impact Socket 1-1/4"
84550	1/2" Drive 6 Point Deep Impact Socket 5/8"	84561	1/2" Drive 6 Point Deep Impact Socket 1-5/16"
84551	1/2" Drive 6 Point Deep Impact Socket 11/16"	84562	1/2" Drive 6 Point Deep Impact Socket 1-3/8"
84552D	1/2" Drive 6 Point Deep Impact Socket 3/4"	84563	1/2" Drive 6 Point Deep Impact Socket 1-7/16"
84553	1/2" Drive 6 Point Deep Impact Socket 13/16"	84564	1/2" Drive 6 Point Deep Impact Socket 1-1/2"
84554D	1/2" Drive 6 Point Deep Impact Socket 7/8"	84559	1/2" Drive 6 Point Deep Impact Socket 1-13/16"
84555D	1/2" Drive 6 Point Deep Impact Socket 15/16"		

GEARWRENCH® 12 Pc. 1/2" Drive 6 Point SAE Deep Impact Socket Set

- Chrome Molybdenum Alloy Steel (Cr-Mo) for Exceptional Strength and Durability
- Surface Drive™ Technology Reduces Fastener Rounding
- Manganese Phosphate Coating to Resist Corrosion
- High Visibility Laser Etched Markings
- Secondary Hard Stamping
- Includes Blow Mold Case
- Meets or Exceeds ASME B107.2



Cat. No.	UPC No.	Packaging	Product Weight
84942	099575849428	Case	7.92 lb

Cat. No.	Description	Cat. No.	Description
84546	1/2" Drive 6 Point Deep Impact Socket 3/8"	84552D	1/2" Drive 6 Point Deep Impact Socket 3/4"
84547	1/2" Drive 6 Point Deep Impact Socket 7/16"	84553	1/2" Drive 6 Point Deep Impact Socket 13/16"
84548	1/2" Drive 6 Point Deep Impact Socket 1/2"	84554D	1/2" Drive 6 Point Deep Impact Socket 7/8"
84549	1/2" Drive 6 Point Deep Impact Socket 9/16"	84555D	1/2" Drive 6 Point Deep Impact Socket 15/16"
84550	1/2" Drive 6 Point Deep Impact Socket 5/8"	84556	1/2" Drive 6 Point Deep Impact Socket 1"
84551	1/2" Drive 6 Point Deep Impact Socket 11/16"	84557	1/2" Drive 6 Point Deep Impact Socket 1-1/16"

1 / 2 "

4

IMPACT SOCKETS

GEARWRENCH® 29 Pc. 1/2" Drive 6 Point Metric Deep Impact Socket Set

- Chrome Molybdenum Alloy Steel (Cr-Mo) for Exceptional Strength and Durability
- Surface Drive™ Technology Reduces Fastener Rounding
- Manganese Phosphate Coating to Resist Corrosion
- High Visibility Laser Etched Markings
- Secondary Hard Stamping
- Includes Blow Mold Case
- Meets or Exceeds ASME B107.33M



Cat. No.	UPC No.	Packaging	Product Weight
84935	099575849350	Case	20.56 lb

Cat. No.	Description	Cat. No.	Description
84566	1/2" Drive 6 Point Deep Impact Socket 8mm	84581	1/2" Drive 6 Point Deep Impact Socket 23mm
84567	1/2" Drive 6 Point Deep Impact Socket 9mm	84582	1/2" Drive 6 Point Deep Impact Socket 24mm
84568	1/2" Drive 6 Point Deep Impact Socket 10mm	84583	1/2" Drive 6 Point Deep Impact Socket 25mm
84569	1/2" Drive 6 Point Deep Impact Socket 11mm	84584	1/2" Drive 6 Point Deep Impact Socket 26mm
84570	1/2" Drive 6 Point Deep Impact Socket 12mm	84585D	1/2" Drive 6 Point Deep Impact Socket 27mm
84571	1/2" Drive 6 Point Deep Impact Socket 13mm	84586D	1/2" Drive 6 Point Deep Impact Socket 28mm
84572	1/2" Drive 6 Point Deep Impact Socket 14mm	84587	1/2" Drive 6 Point Deep Impact Socket 29mm
84573	1/2" Drive 6 Point Deep Impact Socket 15mm	84588	1/2" Drive 6 Point Deep Impact Socket 30mm
84574	1/2" Drive 6 Point Deep Impact Socket 16mm	84589D	1/2" Drive 6 Point Deep Impact Socket 31mm
84575D	1/2" Drive 6 Point Deep Impact Socket 17mm	84590D	1/2" Drive 6 Point Deep Impact Socket 32mm
84576D	1/2" Drive 6 Point Deep Impact Socket 18mm	84591	1/2" Drive 6 Point Deep Impact Socket 33mm
84577	1/2" Drive 6 Point Deep Impact Socket 19mm	84592	1/2" Drive 6 Point Deep Impact Socket 34mm
84578	1/2" Drive 6 Point Deep Impact Socket 20mm	84593D	1/2" Drive 6 Point Deep Impact Socket 35mm
84579	1/2" Drive 6 Point Deep Impact Socket 21mm	84594D	1/2" Drive 6 Point Deep Impact Socket 36mm
84580	1/2" Drive 6 Point Deep Impact Socket 22mm		

GEARWRENCH® 12 Pc. 1/2" Drive 6 Point Metric Deep Impact Socket Set

- Chrome Molybdenum Alloy Steel (Cr-Mo) for Exceptional Strength and Durability
- Surface Drive™ Technology Reduces Fastener Rounding
- Manganese Phosphate Coating to Resist Corrosion
- High Visibility Laser Etched Markings
- Secondary Hard Stamping
- Includes Blow Mold Case
- Meets or Exceeds ASME B107.33M



Cat. No.	UPC No.	Packaging	Product Weight
84944	099575849442	Case	6.00 lb

Cat. No.	Description	Cat. No.	Description
84566	1/2" Drive 6 Point Deep Impact Socket 8mm	84572	1/2" Drive 6 Point Deep Impact Socket 14mm
84567	1/2" Drive 6 Point Deep Impact Socket 9mm	84573	1/2" Drive 6 Point Deep Impact Socket 15mm
84568	1/2" Drive 6 Point Deep Impact Socket 10mm	84574	1/2" Drive 6 Point Deep Impact Socket 16mm
84569	1/2" Drive 6 Point Deep Impact Socket 11mm	84575D	1/2" Drive 6 Point Deep Impact Socket 17mm
84570	1/2" Drive 6 Point Deep Impact Socket 12mm	84576D	1/2" Drive 6 Point Deep Impact Socket 18mm
84571	1/2" Drive 6 Point Deep Impact Socket 13mm	84577	1/2" Drive 6 Point Deep Impact Socket 19mm

1 / 2 "

4

I M P A C T S O C K E T S

GEARWRENCH® 3 Pc. Metric High-Strength Wheel Protector Impact Socket Set

- High-Strength Impact Socket for up to 3x Longer Life Than Regular Thin Wall Impact Sockets
- Thin Wall Socket Design for Access in Confined Spaces
- Protective Outer Sheath Prevents Damage to Wheels
- Insert Protects Lug Nuts and Bolts from Damage
- Manganese Phosphate Coating to Resist Corrosion
- Meets or Exceeds ASME B107.33M



Cat. No.	UPC No.	Product Weight
84946	099575849466	1.75 lb

Cat. No.	Description	Cat. No.	Description
-	1/2" Drive 6 Point Thin Wall Socket 17mm	-	1/2" Drive 6 Point Thin Wall Socket 21mm
-	1/2" Drive 6 Point Thin Wall Socket 19mm		

GEARWRENCH® 7 Pc. 1/2" Drive SAE Impact Hex Bit Socket Set

- Chrome Molybdenum Alloy Steel (Cr-Mo) for Exceptional Strength and Durability
- Pin Hole for Use with Pin and O-Ring for Secure Socket Retention
- Manganese Phosphate Coating to Resist Corrosion
- High Visibility Laser Etched Markings
- Secondary Hard Stamping
- Includes Plastic Socket Rail
- Meets or Exceeds ASME B107.2



Cat. No.	UPC No.	Packaging	Product Weight
84941	099575849411	Carded	2.07 lb

Cat. No.	Description	Cat. No.	Description
84634	1/2" Drive Impact Hex Socket 3/8"	84638	1/2" Drive Impact Hex Socket 5/8"
84635	1/2" Drive Impact Hex Socket 7/16"	84639	1/2" Drive Impact Hex Socket 11/16"
84636	1/2" Drive Impact Hex Socket 1/2"	84640	1/2" Drive Impact Hex Socket 3/4"
84637	1/2" Drive Impact Hex Socket 9/16"		

GEARWRENCH® 7 Pc. 1/2" Drive Metric Impact Hex Bit Socket Set

- Chrome Molybdenum Alloy Steel (Cr-Mo) for Exceptional Strength and Durability
- Pin Hole for Use with Pin and O-Ring for Secure Socket Retention
- Manganese Phosphate Coating to Resist Corrosion
- High Visibility Laser Etched Markings
- Secondary Hard Stamping
- Includes Plastic Socket Rail
- Meets or Exceeds ASME B107.33M



Cat. No.	UPC No.	Packaging	Product Weight
84940	099575849404	Carded	1.87 lb

Cat. No.	Description	Cat. No.	Description
84626	1/2" Drive Impact Hex Socket 9mm	84630	1/2" Drive Impact Hex Socket 13mm
84627	1/2" Drive Impact Hex Socket 10mm	84631	1/2" Drive Impact Hex Socket 14mm
84628	1/2" Drive Impact Hex Socket 11mm	84632	1/2" Drive Impact Hex Socket 15mm
84629	1/2" Drive Impact Hex Socket 12mm		

1/2"

4

IMPACT SOCKETS

GEARWRENCH® 13 Pc. 1/2" Drive 6 Point SAE Impact Universal Socket Set

- Chrome Molybdenum Alloy Steel (Cr-Mo) for Exceptional Strength and Durability
- Surface Drive™ Technology Reduces Fastener Rounding
- Manganese Phosphate Coating to Resist Corrosion
- High Visibility Laser Etched Markings
- Includes Blow Mold Case



Cat. No.	UPC No.	Packaging	Product Weight
84938	099575849381	Case	7.90 lb

Cat. No.	Description	Cat. No.	Description
84596D	1/2" Drive Impact Universal Socket 1/2"	84603	1/2" Drive Impact Universal Socket 15/16"
84597	1/2" Drive Impact Universal Socket 9/16"	84604	1/2" Drive Impact Universal Socket 1"
84598	1/2" Drive Impact Universal Socket 5/8"	84605	1/2" Drive Impact Universal Socket 1-1/16"
84599	1/2" Drive Impact Universal Socket 11/16"	84606	1/2" Drive Impact Universal Socket 1-1/8"
84600	1/2" Drive Impact Universal Socket 3/4"	84607	1/2" Drive Impact Universal Socket 1-3/16"
84601	1/2" Drive Impact Universal Socket 13/16"	84608	1/2" Drive Impact Universal Socket 1-1/4"
84602	1/2" Drive Impact Universal Socket 7/8"		

GEARWRENCH® 15 Pc. 1/2" Drive 6 Point Metric Impact Universal Socket Set

- Chrome Molybdenum Alloy Steel (Cr-Mo) for Exceptional Strength and Durability
- Surface Drive™ Technology Reduces Fastener Rounding
- Manganese Phosphate Coating to Resist Corrosion
- High Visibility Laser Etched Markings
- Includes Blow Mold Case



Cat. No.	UPC No.	Packaging	Product Weight
84939	099575849398	Case	7.85 lb

Cat. No.	Description	Cat. No.	Description
84610	1/2" Drive Impact Universal Socket 10mm	84618	1/2" Drive Impact Universal Socket 18mm
84611	1/2" Drive Impact Universal Socket 11mm	84619	1/2" Drive Impact Universal Socket 19mm
84612	1/2" Drive Impact Universal Socket 12mm	84620	1/2" Drive Impact Universal Socket 20mm
84613	1/2" Drive Impact Universal Socket 13mm	84621	1/2" Drive Impact Universal Socket 21mm
84614	1/2" Drive Impact Universal Socket 14mm	84622	1/2" Drive Impact Universal Socket 22mm
84615	1/2" Drive Impact Universal Socket 15mm	84623	1/2" Drive Impact Universal Socket 23mm
84616	1/2" Drive Impact Universal Socket 16mm	84624	1/2" Drive Impact Universal Socket 24mm
84617	1/2" Drive Impact Universal Socket 17mm		

1 / 2 "

4

I M P A C T S O C K E T S

GEARWRENCH® 1/2" Drive Impact Extensions

- Chrome Molybdenum Alloy Steel (Cr-Mo) for Exceptional Strength and Long Lasting Durability
- Pin Hole for Use with Pin and O-Ring for Secure Socket Retention
- High Visibility Laser Etched Markings
- Meets or Exceeds ASME B107.2



Cat. No.	UPC No.	Packaging	Male Drive Size	Female Drive Size	Overall Length	Product Weight
84645	099575846458	Carded	1/2"	1/2"	3 in	0.33 lb
84646	099575846465	Carded	1/2"	1/2"	5 in	0.45 lb
84644	099575846441	Carded	1/2"	1/2"	10 in	0.90 lb

GEARWRENCH® 1/2" Drive Impact Drive Adapter

- Chrome Molybdenum Alloy Steel (Cr-Mo) for Exceptional Strength and Long Lasting Durability
- Manganese Phosphate Coating to Resist Corrosion
- Meets or Exceeds ASME B107.1



Cat. No.	UPC No.	Packaging	Female Drive Size	Male Drive Size	Dim. A: Drive End	Length	Product Weight
84643	099575846434	Carded	1/2"	3/8"	1.00 in	1.500 in	0.16 lb

GEARWRENCH® 1/2" Drive Impact Universal Joint

- Chrome Molybdenum Alloy Steel (Cr-Mo) for Exceptional Strength and Long Lasting Durability
- Manganese Phosphate Coating to Resist Corrosion
- Meets or Exceeds ASME B107.2



Cat. No.	UPC No.	Packaging	Female Drive Size	Male Drive Size	Dim. A: Drive End	Length	Product Weight
80671	099575806711	Carded	1/2"	1/2"	1.08 in	2.530 in	0.33 lb

1 / 2 "

4

IMPACT SOCKETS

GEARWRENCH® 1/2" Drive 6 Point SAE Impact Sockets

- Chrome Molybdenum Alloy Steel (Cr-Mo) for Exceptional Strength and Durability
- Surface Drive™ Technology Reduces Fastener Rounding
- Manganese Phosphate Coating to Resist Corrosion
- High Visibility Laser Etched Markings
- Secondary Hard Stamping
- Meets or Exceeds ASME B107.2

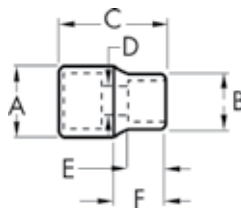

Cat. No.	UPC No.	Packaging	Fastener Size	Dim. A: Drive End	Dim. B: Wrench End	Dim. C: Overall Length	Dim. D: Bolt Clearance	Dim. E: Wrench Depth	Dim. F: Length to Shoulder	Product Weight
84500D	099575845000	Carded	3/8 in	0.866 in	0.630 in	1.496 in	0.281 in	0.117 in	0.393 in	0.14 lb
84501	099575845017	Carded	7/16 in	0.866 in	0.709 in	1.496 in	0.281 in	0.203 in	0.393 in	0.14 lb
84502	099575845024	Carded	1/2 in	0.866 in	0.787 in	1.496 in	0.344 in	0.209 in	0.393 in	0.16 lb
84503	099575845031	Carded	9/16 in	0.945 in	0.866 in	1.496 in	0.406 in	0.249 in	0.393 in	0.18 lb
84504D	099575845048	Carded	5/8 in	0.984 in	0.984 in	1.496 in	0.469 in	0.281 in	1.496 in	0.20 lb
84505D	099575845055	Carded	11/16 in	1.024 in	1.024 in	1.496 in	0.469 in	0.318 in	1.496 in	0.22 lb
84506D	099575845062	Carded	3/4 in	1.102 in	1.102 in	1.496 in	0.531 in	0.356 in	1.496 in	0.22 lb
84507D	099575845079	Carded	13/16 in	1.181 in	1.181 in	1.496 in	0.594 in	0.418 in	1.496 in	0.22 lb
84508D	099575845086	Carded	7/8 in	1.260 in	1.260 in	1.496 in	0.594 in	0.479 in	1.496 in	0.29 lb
84509D	099575845093	Carded	15/16 in	1.339 in	1.339 in	1.496 in	0.656 in	0.490 in	1.496 in	0.37 lb
84510D	099575845109	Carded	1 in	1.417 in	1.417 in	1.496 in	0.656 in	0.490 in	1.496 in	0.41 lb
84511D	099575845116	Carded	1-1/16 in	1.496 in	1.496 in	1.575 in	0.687 in	0.490 in	1.574 in	0.46 lb
84512D	099575845123	Carded	1-1/8 in	1.496 in	1.575 in	1.575 in	0.781 in	0.632 in	1.574 in	0.50 lb
84513D	099575845130	Carded	1-3/16 in	1.496 in	1.654 in	1.575 in	0.781 in	0.632 in	1.574 in	0.53 lb
84514D	099575845147	Carded	1-1/4 in	1.496 in	1.732 in	1.575 in	0.812 in	0.632 in	1.574 in	0.53 lb
84515D	099575845154	Carded	1-5/16 in	1.496 in	1.772 in	1.693 in	0.906 in	0.748 in	1.692 in	0.56 lb
84516D	099575845161	Carded	1-3/8 in	1.496 in	1.850 in	1.693 in	0.937 in	0.748 in	1.692 in	0.60 lb
84517D	099575845178	Carded	1-7/16 in	1.496 in	1.890 in	1.693 in	1.000 in	0.748 in	1.692 in	0.75 lb
84518D	099575845185	Carded	1-1/2 in	1.496 in	1.968 in	1.693 in	1.062 in	0.847 in	1.771 in	0.94 lb

1 / 2 "

4

I M P A C T S O C K E T S

GEARWRENCH® 1/2" Drive 6 Point Metric Impact Sockets

- Chrome Molybdenum Alloy Steel (Cr-Mo) for Exceptional Strength and Durability
- Surface Drive™ Technology Reduces Fastener Rounding
- Manganese Phosphate Coating to Resist Corrosion
- High Visibility Laser Etched Markings
- Secondary Hard Stamping
- Meets or Exceeds ASME B107.33M

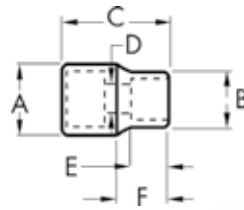

Cat. No.	UPC No.	Packaging	Fastener Size	Dim. A: Drive End	Dim. B: Wrench End	Dim. C: Overall Length	Dim. D: Bolt Clearance	Dim. E: Wrench Depth	Dim. F: Length to Shoulder	Product Weight
84520	099575845208	Carded	8 mm	0.866 in	0.571 in	1.496 in	0.209 in	0.159 in	0.393 in	0.13 lb
84521D	099575845215	Carded	9 mm	0.866 in	0.614 in	1.496 in	0.209 in	0.159 in	0.393 in	0.13 lb
84522D	099575845222	Carded	10 mm	0.866 in	0.657 in	1.496 in	0.259 in	0.181 in	0.393 in	0.14 lb
84523D	099575845239	Carded	11 mm	0.866 in	0.709 in	1.496 in	0.299 in	0.214 in	0.393 in	0.14 lb
84524D	099575845246	Carded	12 mm	0.866 in	0.748 in	1.496 in	0.327 in	0.240 in	0.393 in	0.15 lb
84525D	099575845253	Carded	13 mm	0.945 in	0.795 in	1.496 in	0.327 in	0.265 in	0.393 in	0.19 lb
84526D	099575845260	Carded	14 mm	0.945 in	0.846 in	1.496 in	0.407 in	0.328 in	0.393 in	0.21 lb
84527D	099575845277	Carded	15 mm	0.984 in	0.906 in	1.496 in	0.407 in	0.328 in	0.393 in	0.21 lb
84528D	099575845284	Carded	16 mm	0.984 in	0.984 in	1.496 in	0.459 in	0.375 in	1.496 in	0.22 lb
84529D	099575845291	Carded	17 mm	1.024 in	1.024 in	1.496 in	0.486 in	0.375 in	1.496 in	0.22 lb
84530D	099575845307	Carded	18 mm	1.063 in	1.063 in	1.496 in	0.486 in	0.399 in	1.496 in	0.24 lb
84531	099575845314	Carded	19 mm	1.102 in	1.102 in	1.496 in	0.531 in	0.437 in	1.496 in	0.33 lb
84532	099575845321	Carded	20 mm	1.181 in	1.181 in	1.496 in	0.551 in	0.452 in	1.496 in	0.37 lb
84533	099575845338	Carded	21 mm	1.181 in	1.181 in	1.496 in	0.590 in	0.460 in	1.496 in	0.42 lb
84534	099575845345	Carded	22 mm	1.260 in	1.260 in	1.496 in	0.590 in	0.490 in	1.496 in	0.42 lb
84535	099575845352	Carded	23 mm	1.299 in	1.299 in	1.496 in	0.629 in	0.499 in	1.496 in	0.45 lb
84536	099575845369	Carded	24 mm	1.339 in	1.339 in	1.496 in	0.688 in	0.545 in	1.496 in	0.45 lb
84537	099575845376	Carded	25 mm	1.417 in	1.417 in	1.654 in	0.720 in	0.551 in	1.653 in	0.50 lb
84538	099575845383	Carded	26 mm	1.417 in	1.417 in	1.654 in	0.720 in	0.574 in	1.653 in	0.58 lb
84539	099575845390	Carded	28 mm	1.496 in	1.496 in	1.654 in	0.720 in	0.574 in	1.653 in	0.65 lb
84540	099575845406	Carded	29 mm	1.614 in	1.614 in	1.654 in	0.787 in	0.655 in	1.653 in	0.70 lb
84541	099575845413	Carded	30 mm	1.496 in	1.654 in	1.654 in	0.787 in	0.655 in	1.653 in	0.78 lb
84542	099575845420	Carded	31 mm	1.496 in	1.654 in	1.654 in	0.787 in	0.655 in	1.653 in	0.78 lb
84543	099575845437	Carded	32 mm	1.496 in	1.732 in	1.654 in	0.905 in	0.720 in	1.653 in	0.85 lb
84544	099575845444	Carded	36 mm	1.496 in	1.968 in	1.968 in	1.023 in	0.787 in	1.889 in	0.92 lb

1 / 2 "

4

IMPACT SOCKETS

GEARWRENCH® 1/2" Drive 6 Point SAE Deep Impact Sockets

- Chrome Molybdenum Alloy Steel (Cr-Mo) for Exceptional Strength and Durability
- Surface Drive™ Technology Reduces Fastener Rounding
- Manganese Phosphate Coating to Resist Corrosion
- High Visibility Laser Etched Markings
- Secondary Hard Stamping
- Meets or Exceeds ASME B107.2

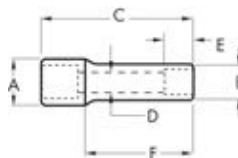

Cat. No.	UPC No.	Packaging	Fastener Size	Dim. A: Drive End	Dim. B: Wrench End	Dim. C: Overall Length	Dim. D: Bolt Clearance	Dim. E: Wrench Depth	Dim. F: Length to Shoulder	Product Weight
84546	099575845468	Carded	3/8 in	0.866 in	0.630 in	3.071 in	0.281 in	0.117 in	0.669 in	0.35 lb
84547	099575845475	Carded	7/16 in	0.866 in	0.709 in	3.071 in	0.281 in	0.203 in	0.669 in	0.40 lb
84548	099575845482	Carded	1/2 in	0.866 in	0.787 in	3.071 in	0.344 in	0.209 in	0.669 in	0.42 lb
84549	099575845499	Carded	9/16 in	0.945 in	0.866 in	3.071 in	0.406 in	0.249 in	3.070 in	0.45 lb
84550	099575845505	Carded	5/8 in	0.984 in	0.984 in	3.071 in	0.469 in	0.281 in	3.070 in	0.47 lb
84551	099575845512	Carded	11/16 in	1.024 in	1.024 in	3.071 in	0.469 in	0.318 in	3.070 in	0.53 lb
84552D	099575845529	Carded	3/4 in	1.102 in	1.102 in	3.071 in	0.531 in	0.358 in	3.070 in	0.53 lb
84553	099575845536	Carded	13/16 in	1.181 in	1.181 in	3.071 in	0.594 in	0.418 in	3.070 in	0.59 lb
84554D	099575845543	Carded	7/8 in	1.260 in	1.260 in	3.071 in	0.594 in	0.479 in	3.070 in	0.65 lb
84555D	099575845550	Carded	15/16 in	1.339 in	1.339 in	3.071 in	0.656 in	0.490 in	3.070 in	0.76 lb
84556	099575845567	Carded	1 in	1.417 in	1.417 in	3.071 in	0.656 in	0.490 in	3.070 in	0.85 lb
84557	099575845574	Carded	1-1/16 in	1.496 in	1.496 in	3.071 in	0.687 in	0.490 in	3.070 in	0.92 lb
84558	099575845581	Carded	1-1/8 in	1.496 in	1.575 in	3.071 in	0.781 in	0.632 in	3.070 in	0.94 lb
84560	099575845604	Carded	1-1/4 in	1.496 in	1.732 in	3.071 in	0.812 in	0.632 in	3.070 in	1.10 lb
84561	099575845611	Carded	1-5/16 in	1.496 in	1.772 in	3.071 in	0.906 in	0.748 in	3.070 in	1.10 lb
84562	099575845628	Carded	1-3/8 in	1.496 in	1.850 in	3.071 in	0.937 in	0.748 in	3.070 in	1.12 lb
84563	099575845635	Carded	1-7/16 in	1.496 in	1.890 in	3.071 in	1.000 in	0.748 in	3.070 in	1.24 lb
84564	099575845642	Carded	1-1/2 in	1.496 in	1.968 in	3.071 in	1.062 in	0.847 in	3.070 in	1.24 lb
84559	099575845598	Carded	1-13/16 in	1.496 in	1.654 in	3.071 in	1.062 in	0.847 in	3.661 in	1.35 lb

1 / 2 "

4

I M P A C T S O C K E T S

GEARWRENCH® 1/2" Drive 6 Point Metric Deep Impact Sockets

- Chrome Molybdenum Alloy Steel (Cr-Mo) for Exceptional Strength and Durability
- Surface Drive™ Technology Reduces Fastener Rounding
- Manganese Phosphate Coating to Resist Corrosion
- High Visibility Laser Etched Markings
- Secondary Hard Stamping
- Meets or Exceeds ASME B107.33M

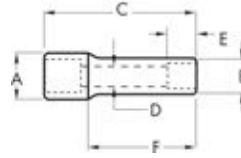

Cat. No.	UPC No.	Packaging	Fastener Size	Dim. A: Drive End	Dim. B: Wrench End	Dim. C: Overall Length	Dim. D: Bolt Clearance	Dim. E: Wrench Depth	Dim. F: Length to Shoulder	Product Weight
84566	099575845666	Carded	8 mm	0.866 in	0.571 in	3.071 in	0.209 in	0.159 in	0.669 in	0.33 lb
84567	099575845673	Carded	9 mm	0.866 in	0.614 in	3.071 in	0.209 in	0.159 in	0.669 in	0.33 lb
84568	099575845680	Carded	10 mm	0.866 in	0.657 in	3.071 in	0.259 in	0.181 in	0.669 in	0.35 lb
84569	099575845697	Carded	11 mm	0.866 in	0.709 in	3.071 in	0.299 in	0.214 in	0.669 in	0.35 lb
84570	099575845703	Carded	12 mm	0.866 in	0.748 in	3.071 in	0.327 in	0.240 in	0.669 in	0.35 lb
84571	099575845710	Carded	13 mm	0.945 in	0.795 in	3.071 in	0.327 in	0.265 in	0.669 in	0.40 lb
84572	099575845727	Carded	14 mm	0.945 in	0.846 in	3.071 in	0.407 in	0.328 in	0.669 in	0.40 lb
84573	099575845734	Carded	15 mm	0.945 in	0.945 in	3.071 in	0.407 in	0.328 in	3.070 in	0.40 lb
84574	099575845741	Carded	16 mm	0.984 in	0.984 in	3.071 in	0.459 in	0.375 in	3.070 in	0.43 lb
84575D	099575845758	Carded	17 mm	1.024 in	1.024 in	3.071 in	0.486 in	0.375 in	3.070 in	0.44 lb
84576D	099575845765	Carded	18 mm	1.024 in	1.024 in	3.071 in	0.486 in	0.399 in	3.070 in	0.46 lb
84577	099575845772	Carded	19 mm	1.102 in	1.102 in	3.071 in	0.531 in	0.437 in	3.070 in	0.51 lb
84578	099575845789	Carded	20 mm	1.181 in	1.181 in	3.071 in	0.551 in	0.452 in	3.070 in	0.61 lb
84579	099575845796	Carded	21 mm	1.181 in	1.181 in	3.071 in	0.590 in	0.460 in	3.070 in	0.65 lb
84580	099575845802	Carded	22 mm	1.260 in	1.260 in	3.071 in	0.590 in	0.490 in	3.070 in	0.66 lb
84581	099575845819	Carded	23 mm	1.260 in	1.260 in	3.071 in	0.629 in	0.499 in	3.070 in	0.68 lb
84582	099575845826	Carded	24 mm	1.339 in	1.339 in	3.071 in	0.688 in	0.545 in	3.070 in	0.76 lb
84583	099575845833	Carded	25 mm	1.417 in	1.417 in	3.071 in	0.720 in	0.551 in	3.070 in	0.78 lb
84584	099575845840	Carded	26 mm	1.417 in	1.417 in	3.071 in	0.720 in	0.574 in	3.070 in	0.85 lb
84585D	099575845857	Carded	27 mm	1.496 in	1.496 in	3.071 in	0.720 in	0.622 in	3.070 in	0.97 lb
84586D	099575845864	Carded	28 mm	1.575 in	1.575 in	3.071 in	0.720 in	0.622 in	3.070 in	0.99 lb
84587	099575845871	Carded	29 mm	1.575 in	1.575 in	3.071 in	0.787 in	0.655 in	3.070 in	1.02 lb
84588	099575845888	Carded	30 mm	1.496 in	1.654 in	3.071 in	0.787 in	0.655 in	3.070 in	1.04 lb
84589D	099575845895	Carded	31 mm	1.496 in	1.732 in	3.071 in	0.787 in	0.655 in	3.070 in	1.08 lb
84590D	099575845901	Carded	32 mm	1.496 in	1.732 in	3.071 in	0.905 in	0.720 in	3.070 in	1.10 lb
84591	099575845918	Carded	33 mm	1.496 in	1.811 in	3.071 in	0.905 in	0.720 in	3.070 in	1.15 lb
84592	099575845925	Carded	34 mm	1.496 in	1.890 in	3.071 in	0.905 in	0.787 in	3.070 in	1.21 lb
84593D	099575845932	Carded	35 mm	1.496 in	1.890 in	3.071 in	0.905 in	0.787 in	3.070 in	1.26 lb
84594D	099575845949	Carded	36 mm	1.496 in	1.968 in	3.071 in	1.023 in	0.787 in	3.070 in	1.26 lb

1 / 2 "

4

IMPACT SOCKETS

GEARWRENCH® 1/2" Drive SAE Impact Hex Bit Sockets

- Chrome Molybdenum Alloy Steel (Cr-Mo) for Exceptional Strength and Durability
- Pin Hole for Use with Pin and O-Ring for Secure Socket Retention
- Manganese Phosphate Coating to Resist Corrosion
- High Visibility Laser Etched Markings
- Secondary Hard Stamping
- Meets or Exceeds ASME B107.2

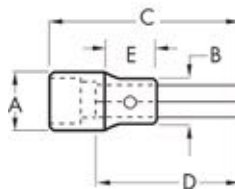

Cat. No.	UPC No.	Packaging	Fastener Size	Dim. A: Drive End	Dim. B: Nose Diameter	Dim. C: Overall Length	Dim. D: Bit Length	Dim. E: Length to Shoulder	Product Weight
84634	099575846342	Carded	3/8 in	0.98 in	0.38 in	3.07 in	0.43 in	0.78 in	0.24 lb
84635	099575846359	Carded	7/16 in	0.98 in	0.44 in	3.07 in	0.51 in	0.78 in	0.26 lb
84636	099575846366	Carded	1/2 in	0.98 in	0.50 in	3.07 in	0.58 in	0.78 in	0.29 lb
84637	099575846373	Carded	9/16 in	0.98 in	0.56 in	3.07 in	0.65 in	0.78 in	0.31 lb
84638	099575846380	Carded	5/8 in	0.98 in	0.62 in	3.07 in	0.71 in	0.78 in	0.34 lb
84639	099575846397	Carded	11/16 in	0.98 in	0.69 in	3.07 in	0.79 in	0.77 in	0.38 lb
84640	099575846403	Carded	3/4 in	0.98 in	0.75 in	3.07 in	0.87 in	0.78 in	0.42 lb

GEARWRENCH® 1/2" Drive Metric Impact Hex Bit Sockets

- Chrome Molybdenum Alloy Steel (Cr-Mo) for Exceptional Strength and Durability
- Pin Hole for Use with Pin and O-Ring for Secure Socket Retention
- Manganese Phosphate Coating to Resist Corrosion
- High Visibility Laser Etched Markings
- Secondary Hard Stamping
- Meets or Exceeds ASME B107.33M

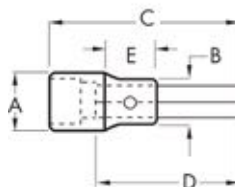

Cat. No.	UPC No.	Packaging	Fastener Size	Dim. A: Drive End	Dim. B: Nose Diameter	Dim. C: Overall Length	Dim. D: Bit Length	Dim. E: Length to Shoulder	Product Weight
84626	099575846267	Carded	9 mm	0.98 in	0.35 in	3.07 in	0.41 in	0.80 in	0.20 lb
84627	099575846274	Carded	10 mm	0.98 in	0.39 in	3.07 in	0.45 in	0.78 in	0.24 lb
84628	099575846281	Carded	11 mm	0.98 in	0.43 in	3.07 in	0.50 in	0.79 in	0.25 lb
84629	099575846298	Carded	12 mm	0.98 in	0.47 in	3.07 in	0.54 in	0.77 in	0.27 lb
84630	099575846304	Carded	13 mm	0.98 in	0.51 in	3.07 in	0.59 in	0.79 in	0.28 lb
84631	099575846311	Carded	14 mm	0.98 in	0.55 in	3.07 in	0.64 in	0.77 in	0.31 lb
84632	099575846328	Carded	15 mm	0.98 in	0.59 in	3.07 in	0.68 in	0.78 in	0.33 lb

1 / 2 "

4

I M P A C T S O C K E T S

GEARWRENCH® 1/2" Drive 6 Point SAE Universal Impact Sockets

- Chrome Molybdenum Alloy Steel (Cr-Mo) for Exceptional Strength and Durability
- Surface Drive™ Technology Reduces Fastener Rounding
- Manganese Phosphate Coating to Resist Corrosion
- High Visibility Laser Etched Markings
- Secondary Hard Stamping
- Meets or Exceeds ASME B107.2

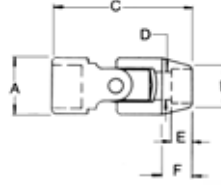

Cat. No.	UPC No.	Packaging	Fastener Size	Dim. A: Drive End	Dim. B: Wrench End	Dim. C: Overall Length	Dim. D: Bolt Clearance	Dim. E: Wrench Depth	Dim. F: Length to Shoulder	Product Weight
84596D	099575845963	Carded	1/2 in	1.083 in	0.748 in	2.598 in	1.080 in	0.760 in	2.620 in	0.39 lb
84597	099575845970	Carded	9/16 in	1.083 in	0.866 in	2.598 in	1.080 in	0.860 in	2.620 in	0.41 lb
84598	099575845987	Carded	5/8 in	1.083 in	0.945 in	2.598 in	1.080 in	0.960 in	2.620 in	0.43 lb
84599	099575845994	Carded	11/16 in	1.083 in	1.024 in	2.598 in	1.080 in	1.030 in	2.620 in	0.42 lb
84600	099575846007	Carded	3/4 in	1.083 in	1.102 in	2.598 in	1.080 in	1.100 in	2.620 in	0.45 lb
84601	099575846014	Carded	13/16 in	1.083 in	1.181 in	2.598 in	1.080 in	1.190 in	2.620 in	0.46 lb
84602	099575846021	Carded	7/8 in	1.083 in	1.260 in	2.598 in	1.080 in	1.260 in	2.620 in	0.48 lb
84603	099575846038	Carded	15/16 in	1.083 in	1.378 in	2.598 in	1.080 in	1.410 in	2.620 in	0.52 lb
84604	099575846045	Carded	1 in	1.083 in	1.389 in	2.598 in	1.080 in	1.500 in	2.620 in	0.58 lb
84605	099575846052	Carded	1-1/16 in	1.083 in	1.562 in	2.598 in	1.080 in	1.570 in	2.790 in	0.57 lb
84606	099575846069	Carded	1-1/8 in	1.083 in	1.781 in	2.598 in	1.080 in	1.580 in	2.790 in	0.62 lb
84607	099575846076	Carded	1-3/16 in	1.083 in	1.802 in	2.598 in	1.080 in	1.650 in	2.790 in	0.64 lb
84608	099575846083	Carded	1-1/4 in	1.083 in	1.947 in	2.598 in	1.080 in	1.740 in	2.790 in	0.67 lb

1 / 2 "

4

I M P A C T S O C K E T S

GEARWRENCH® 1/2" Drive 6 Point Metric Universal Impact Sockets

- Chrome Molybdenum Alloy Steel (Cr-Mo) for Exceptional Strength and Durability
- Surface Drive™ Technology Reduces Fastener Rounding
- Manganese Phosphate Coating to Resist Corrosion
- High Visibility Laser Etched Markings
- Secondary Hard Stamping
- Meets or Exceeds ASME B107.33M

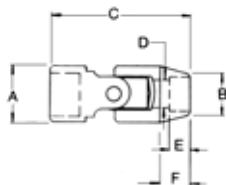

Cat. No.	UPC No.	Packaging	Fastener Size	Dim. A: Drive End	Dim. B: Wrench End	Dim. C: Overall Length	Dim. D: Bolt Clearance	Dim. E: Wrench Depth	Dim. F: Length to Shoulder	Product Weight
84610	099575846106	Carded	10 mm	1.083 in	0.709 in	2.598 in	1.080 in	0.710 in	2.620 in	0.39 lb
84611	099575846113	Carded	11 mm	1.083 in	0.748 in	2.598 in	1.080 in	0.740 in	2.620 in	0.39 lb
84612	099575846120	Carded	12 mm	1.083 in	0.748 in	2.598 in	1.080 in	0.780 in	2.620 in	0.39 lb
84613	099575846137	Carded	13 mm	1.083 in	0.866 in	2.598 in	1.080 in	0.760 in	2.620 in	0.41 lb
84614	099575846144	Carded	14 mm	1.083 in	0.866 in	2.598 in	1.080 in	0.860 in	2.620 in	0.42 lb
84615	099575846151	Carded	15 mm	1.083 in	0.866 in	2.598 in	1.080 in	0.860 in	2.620 in	0.42 lb
84616	099575846168	Carded	16 mm	1.083 in	0.945 in	2.598 in	1.080 in	0.960 in	2.620 in	0.43 lb
84617	099575846175	Carded	17 mm	1.083 in	0.984 in	2.598 in	1.080 in	0.960 in	2.620 in	0.43 lb
84618	099575846182	Carded	18 mm	1.083 in	1.024 in	2.598 in	1.080 in	1.030 in	2.620 in	0.43 lb
84619	099575846199	Carded	19 mm	1.083 in	1.102 in	2.598 in	1.080 in	1.100 in	2.620 in	0.45 lb
84620	099575846205	Carded	20 mm	1.083 in	1.181 in	2.598 in	1.080 in	1.190 in	2.620 in	0.48 lb
84621	099575846212	Carded	21 mm	1.083 in	1.181 in	2.598 in	1.080 in	1.190 in	2.620 in	0.46 lb
84622	099575846229	Carded	22 mm	1.083 in	1.260 in	2.598 in	1.080 in	1.260 in	2.620 in	0.47 lb
84623	099575846236	Carded	23 mm	1.083 in	1.260 in	2.598 in	1.080 in	1.260 in	2.620 in	0.51 lb
84624	099575846243	Carded	24 mm	1.083 in	1.378 in	2.598 in	1.080 in	1.410 in	2.620 in	0.53 lb

GEARWRENCH® 3/4" Drive Impact Extensions

- Chrome Molybdenum Alloy Steel (Cr-Mo) for Exceptional Strength and Long Lasting Durability
- Pin Hole for Use with Pin and O-Ring for Secure Socket Retention
- High Visibility Laser Etched Markings
- Meets or Exceeds ASME B107.2



Cat. No.	UPC No.	Packaging	Male Drive Size	Female Drive Size	Overall Length	Product Weight
84885	099575848858	Carded	3/4"	3/4"	6 in	1.84 lb
84886	099575848865	Carded	3/4"	3/4"	10 in	2.65 lb

1 / 2 "

4

I M P A C T S O C K E T S

GEARWRENCH® 3/4" Drive Impact Drive Adapters

- Chrome Molybdenum Alloy Steel (Cr-Mo) for Exceptional Strength and Long Lasting Durability
- High Visibility Laser Etched Markings
- Meets or Exceeds ASME B107.1



Cat. No.	UPC No.	Packaging	Female Drive Size	Male Drive Size	Dim. A: Drive End	Length	Product Weight
84888D	099575848889	Carded	3/4"	1/2"	1.5 in	2.126 in	0.83 lb
84887	099575848872	Carded	3/4"	1"	1.5 in	2.626 in	1.30 lb

GEARWRENCH® 3/4" Drive 6 Point SAE Impact Sockets

- Chrome Molybdenum Alloy Steel (Cr-Mo) for Exceptional Strength and Durability
- Surface Drive™ Technology Reduces Fastener Rounding
- Manganese Phosphate Coating to Resist Corrosion
- High Visibility Laser Etched Markings
- Secondary Hard Stamping
- Meets or Exceeds ASME B107.2

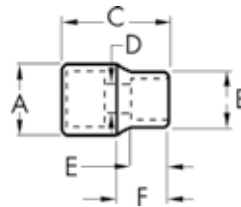

Cat. No.	UPC No.	Packaging	Fastener Size	Dim. A: Drive End	Dim. B: Wrench End	Dim. C: Overall Length	Dim. D: Bolt Clearance	Dim. E: Wrench Depth	Dim. F: Length to Shoulder	Product Weight
84800	099575848001	Carded	3/4 in	1.654 in	1.260 in	2.008 in	0.531 in	0.356 in	0.905 in	0.69 lb
84801	099575848018	Carded	13/16 in	1.654 in	1.378 in	2.008 in	0.594 in	0.418 in	0.905 in	0.71 lb
84802	099575848025	Carded	7/8 in	1.654 in	1.417 in	2.008 in	0.594 in	0.479 in	0.905 in	0.73 lb
84803	099575848032	Carded	15/16 in	1.654 in	1.496 in	2.008 in	0.656 in	0.490 in	0.905 in	0.75 lb
84804	099575848049	Carded	1 in	1.654 in	1.575 in	2.087 in	0.656 in	0.490 in	0.905 in	0.80 lb
84805	099575848056	Carded	1-1/16 in	1.732 in	1.654 in	2.087 in	0.687 in	0.490 in	0.905 in	0.89 lb
84806	099575848063	Carded	1-1/8 in	1.732 in	1.732 in	2.087 in	0.781 in	0.632 in	2.086 in	0.84 lb
84808	099575848087	Carded	1-1/4 in	1.732 in	1.890 in	2.244 in	0.812 in	0.632 in	2.244 in	1.03 lb
84809	099575848094	Carded	1-5/16 in	1.732 in	1.968 in	2.244 in	0.937 in	0.740 in	2.244 in	1.04 lb
84810	099575848100	Carded	1-3/8 in	1.732 in	2.047 in	2.244 in	0.937 in	0.740 in	2.244 in	1.13 lb
84811	099575848117	Carded	1-7/16 in	1.732 in	2.087 in	2.244 in	1.000 in	0.740 in	2.244 in	1.16 lb
84812	099575848124	Carded	1-1/2 in	1.732 in	2.205 in	2.244 in	1.062 in	0.847 in	2.244 in	1.21 lb
84813	099575848131	Carded	1-9/16 in	1.732 in	2.283 in	2.283 in	1.062 in	0.847 in	2.283 in	1.25 lb
84814	099575848148	Carded	1-5/8 in	1.732 in	2.362 in	2.283 in	1.125 in	0.847 in	2.283 in	1.31 lb
84815	099575848155	Carded	1-11/16 in	1.732 in	2.441 in	2.441 in	1.187 in	0.970 in	2.440 in	1.50 lb
84816	099575848162	Carded	1-3/4 in	1.732 in	2.520 in	2.441 in	1.187 in	0.980 in	2.440 in	1.59 lb
84807	099575848070	Carded	1-13/16 in	1.732 in	1.811 in	2.087 in	1.250 in	0.990 in	2.440 in	1.73 lb
84818	099575848186	Carded	1-7/8 in	1.732 in	2.598 in	2.677 in	1.312 in	1.062 in	2.677 in	1.80 lb
84819	099575848193	Carded	1-15/16 in	1.732 in	2.756 in	2.677 in	1.312 in	1.062 in	2.677 in	1.85 lb
84820	099575848209	Carded	2 in	1.732 in	2.795 in	2.677 in	1.375 in	1.062 in	2.677 in	1.90 lb
84821	099575848216	Carded	2-1/16 in	2.126 in	2.874 in	2.795 in	1.437 in	1.150 in	2.795 in	2.30 lb
84822	099575848223	Carded	2-1/8 in	2.126 in	2.953 in	2.795 in	1.437 in	1.150 in	2.795 in	2.55 lb
84823	099575848230	Carded	2-3/16 in	2.126 in	3.031 in	2.795 in	1.50 in	1.193 in	2.795 in	2.55 lb
84824	099575848247	Carded	2-1/4 in	2.126 in	3.150 in	2.874 in	1.562 in	1.276 in	2.874 in	2.75 lb
84825	099575848254	Carded	2-5/16 in	2.126 in	3.150 in	2.874 in	1.562 in	1.276 in	2.874 in	2.79 lb
84826	099575848261	Carded	2-3/8 in	2.126 in	3.268 in	2.874 in	1.562 in	1.303 in	2.952 in	2.83 lb
84827	099575848278	Carded	2-7/16 in	2.126 in	3.268 in	2.874 in	1.562 in	1.303 in	2.952 in	2.93 lb
84828	099575848285	Carded	2-1/2 in	2.126 in	3.268 in	2.874 in	1.562 in	1.303 in	2.952 in	3.13 lb

3 / 4 "

4

IMPACT SOCKETS

GEARWRENCH® 3/4" Drive 6 Point Metric Impact Sockets

- Chrome Molybdenum Alloy Steel (Cr-Mo) for Exceptional Strength and Durability
- Surface Drive™ Technology Reduces Fastener Rounding
- Manganese Phosphate Coating to Resist Corrosion
- High Visibility Laser Etched Markings
- Secondary Hard Stamping
- Meets or Exceeds ASME B107.33M

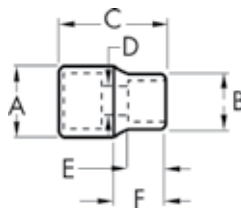

Cat. No.	UPC No.	Packaging	Fastener Size	Dim. A: Drive End	Dim. B: Wrench End	Dim. C: Overall Length	Dim. D: Bolt Clearance	Dim. E: Wrench Depth	Dim. F: Length to Shoulder	Product Weight
84830D	099575848308	Carded	19 mm	1.732 in	1.260 in	1.968 in	0.531 in	0.437 in	0.905 in	0.78 lb
84831	099575848315	Carded	20 mm	1.732 in	1.319 in	1.968 in	0.551 in	0.452 in	0.905 in	0.78 lb
84832	099575848322	Carded	21 mm	1.732 in	1.358 in	1.968 in	0.590 in	0.460 in	0.905 in	0.79 lb
84833	099575848339	Carded	22 mm	1.732 in	1.402 in	1.968 in	0.590 in	0.490 in	0.905 in	0.81 lb
84834	099575848346	Carded	23 mm	1.732 in	1.476 in	1.968 in	0.629 in	0.499 in	0.905 in	0.84 lb
84835	099575848353	Carded	24 mm	1.732 in	1.508 in	1.968 in	0.688 in	0.545 in	0.905 in	0.84 lb
84836	099575848360	Carded	25 mm	1.732 in	1.575 in	1.968 in	0.720 in	0.551 in	0.905 in	0.88 lb
84837	099575848377	Carded	26 mm	1.732 in	1.602 in	1.968 in	0.720 in	0.574 in	0.905 in	0.88 lb
84838	099575848384	Carded	27 mm	1.732 in	1.654 in	1.968 in	0.720 in	0.622 in	0.905 in	0.87 lb
84839	099575848391	Carded	28 mm	1.732 in	1.732 in	1.968 in	0.748 in	0.639 in	2.086 in	0.91 lb
84840	099575848407	Carded	29 mm	1.732 in	1.772 in	2.087 in	0.787 in	0.655 in	2.086 in	0.90 lb
84841	099575848414	Carded	30 mm	1.732 in	1.811 in	2.087 in	0.787 in	0.655 in	2.086 in	0.92 lb
84842	099575848421	Carded	31 mm	1.732 in	1.890 in	2.205 in	0.866 in	0.700 in	2.244 in	1.03 lb
84843	099575848438	Carded	32 mm	1.732 in	1.890 in	2.205 in	0.905 in	0.720 in	2.244 in	1.02 lb
84844D	099575848445	Carded	33 mm	1.732 in	1.968 in	2.205 in	0.944 in	0.749 in	2.244 in	1.09 lb
84845	099575848452	Carded	34 mm	1.732 in	2.008 in	2.205 in	0.944 in	0.787 in	2.244 in	1.09 lb
84846	099575848469	Carded	35 mm	1.732 in	2.047 in	2.205 in	0.944 in	0.791 in	2.244 in	1.12 lb
84847	099575848476	Carded	36 mm	1.732 in	2.087 in	2.205 in	1.023 in	0.844 in	2.244 in	1.14 lb
84848	099575848483	Carded	37 mm	1.732 in	2.165 in	2.205 in	1.023 in	0.844 in	2.244 in	1.16 lb
84849	099575848490	Carded	38 mm	1.732 in	2.205 in	2.205 in	1.062 in	0.875 in	2.244 in	1.17 lb
84850	099575848506	Carded	39 mm	1.732 in	2.244 in	2.205 in	1.062 in	0.875 in	2.283 in	1.15 lb
84851	099575848513	Carded	40 mm	1.732 in	2.323 in	2.205 in	1.141 in	0.895 in	2.283 in	1.26 lb
84852	099575848520	Carded	41 mm	1.732 in	2.323 in	2.205 in	1.200 in	0.980 in	2.283 in	1.31 lb
84853	099575848537	Carded	42 mm	1.732 in	2.402 in	2.205 in	1.220 in	0.999 in	2.283 in	1.33 lb
84854	099575848544	Carded	43 mm	1.732 in	2.402 in	2.205 in	1.220 in	0.999 in	2.440 in	1.46 lb
84855D	099575848551	Carded	44 mm	1.732 in	2.402 in	2.205 in	1.220 in	0.999 in	2.440 in	1.60 lb
84856	099575848568	Carded	45 mm	1.732 in	2.480 in	2.205 in	1.220 in	0.999 in	2.440 in	1.57 lb
84857	099575848575	Carded	46 mm	1.732 in	2.598 in	2.441 in	1.279 in	1.125 in	2.440 in	1.54 lb
84858	099575848582	Carded	47 mm	1.732 in	2.598 in	2.441 in	1.279 in	1.125 in	2.677 in	1.84 lb
84859	099575848599	Carded	48 mm	1.732 in	2.598 in	2.441 in	1.279 in	1.125 in	2.677 in	1.88 lb
84860	099575848605	Carded	49 mm	1.732 in	2.598 in	2.520 in	1.279 in	1.125 in	2.677 in	1.90 lb
84861	099575848612	Carded	50 mm	1.732 in	2.598 in	2.520 in	1.437 in	1.171 in	2.677 in	2.81 lb

3 / 4 "

4

I M P A C T S O C K E T S

GEARWRENCH® 3/4" Drive 6 Point SAE Deep Impact Sockets

- Chrome Molybdenum Alloy Steel (Cr-Mo) for Exceptional Strength and Durability
- Surface Drive™ Technology Reduces Fastener Rounding
- Manganese Phosphate Coating to Resist Corrosion
- High Visibility Laser Etched Markings
- Secondary Hard Stamping
- Meets or Exceeds ASME B107.2

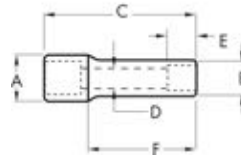

Cat. No.	UPC No.	Packaging	Fastener Size	Dim. A: Drive End	Dim. B: Wrench End	Dim. C: Overall Length	Dim. D: Bolt Clearance	Dim. E: Wrench Depth	Dim. F: Length to Shoulder	Product Weight
84863	099575848636	Carded	3/4 in	1.654 in	1.260 in	3.543 in	0.531 in	0.356 in	2.362 in	1.07 lb
84864	099575848643	Carded	13/16 in	1.654 in	1.378 in	3.543 in	0.594 in	0.418 in	2.362 in	1.16 lb
84865	099575848650	Carded	7/8 in	1.654 in	1.417 in	3.543 in	0.594 in	0.479 in	2.362 in	1.17 lb
84866	099575848667	Carded	15/16 in	1.654 in	1.496 in	3.543 in	0.656 in	0.490 in	2.362 in	1.23 lb
84867	099575848674	Carded	1 in	1.654 in	1.575 in	3.543 in	0.656 in	0.490 in	2.362 in	1.26 lb
84868	099575848681	Carded	1-1/16 in	1.732 in	1.654 in	3.543 in	0.687 in	0.490 in	2.362 in	1.41 lb
84869	099575848698	Carded	1-1/8 in	1.732 in	1.732 in	3.543 in	0.781 in	0.632 in	2.632 in	1.47 lb
84870	099575848704	Carded	1-3/16 in	1.732 in	1.811 in	3.543 in	0.781 in	0.632 in	2.632 in	1.54 lb
84871	099575848711	Carded	1-1/4 in	1.732 in	1.890 in	3.543 in	0.812 in	0.632 in	2.632 in	1.66 lb
84872	099575848728	Carded	1-5/16 in	1.732 in	1.968 in	3.543 in	0.937 in	0.740 in	2.632 in	1.70 lb
84873	099575848735	Carded	1-3/8 in	1.732 in	2.047 in	3.543 in	0.937 in	0.740 in	2.632 in	1.83 lb
84874	099575848742	Carded	1-7/16 in	1.732 in	2.087 in	3.543 in	1.000 in	0.740 in	2.632 in	1.81 lb
84875	099575848759	Carded	1-1/2 in	1.732 in	2.205 in	3.543 in	1.062 in	0.847 in	2.632 in	1.99 lb
84876	099575848766	Carded	1-9/16 in	1.732 in	2.283 in	3.543 in	1.062 in	0.847 in	2.632 in	2.07 lb
84877	099575848773	Carded	1-5/8 in	1.732 in	2.362 in	3.543 in	1.125 in	0.847 in	2.632 in	2.15 lb
84878	099575848780	Carded	1-11/16 in	1.732 in	2.441 in	3.543 in	1.187 in	0.970 in	2.632 in	2.25 lb
84879	099575848797	Carded	1-3/4 in	1.732 in	2.520 in	3.543 in	1.187 in	0.980 in	2.632 in	2.45 lb
84880	099575848803	Carded	1-13/16 in	1.732 in	2.598 in	3.543 in	1.250 in	0.990 in	2.632 in	2.51 lb
84881	099575848810	Carded	1-7/8 in	1.732 in	2.677 in	3.543 in	1.312 in	1.062 in	2.632 in	2.56 lb
84882	099575848827	Carded	1-15/16 in	1.732 in	2.756 in	3.543 in	1.312 in	1.062 in	2.632 in	2.67 lb
84883	099575848834	Carded	2 in	1.732 in	2.795 in	3.543 in	1.375 in	1.062 in	2.632 in	2.79 lb

3 / 4 "

4

IMPACT SOCKETS



GEARWRENCH®

Ratcheting.....	232
Non Ratcheting	287
Specialty	301
Adjustable.....	312

GEARWRENCH® Wrenches

Since being patented in 1996, GearWrench® has been the leader in ratcheting wrenches with more styles and sizes than any other brand. Available in over 25 styles and 450 sizes, GearWrench has a solution for any wrenching problem.

RATCHETING WRENCHES

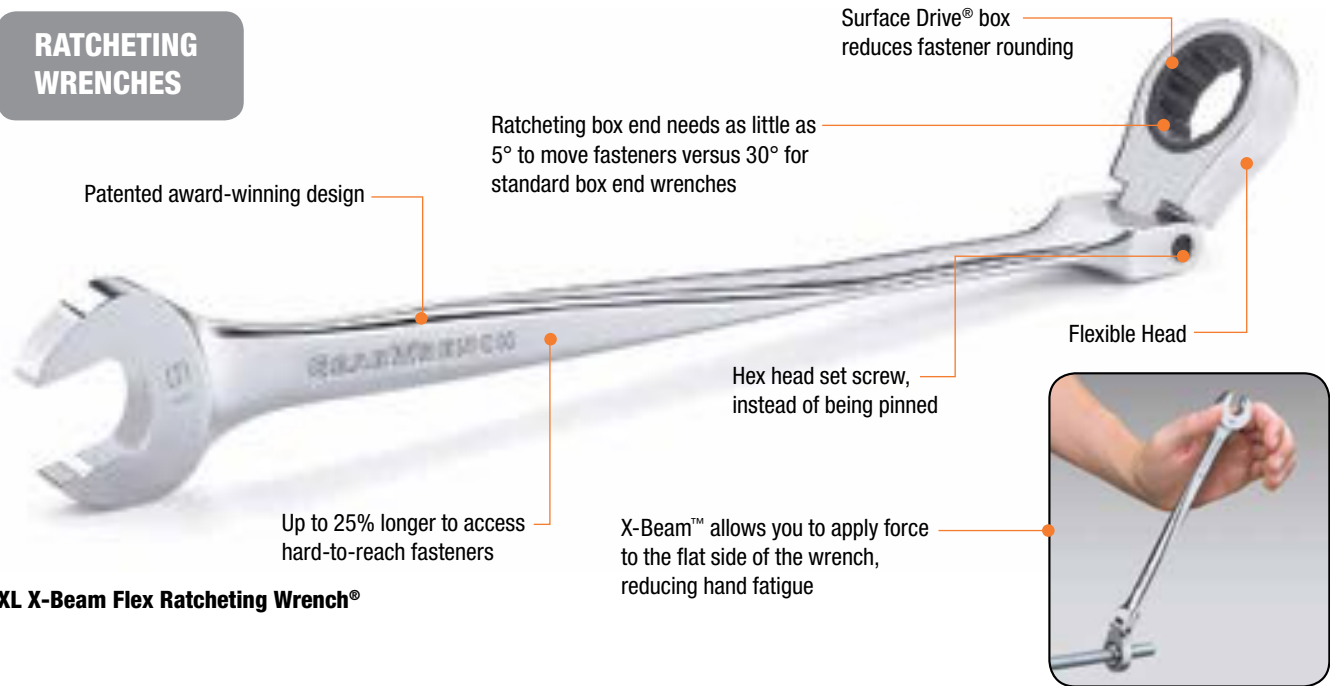

XL X-Beam Flex Ratcheting Wrench®

AVAILABLE IN:



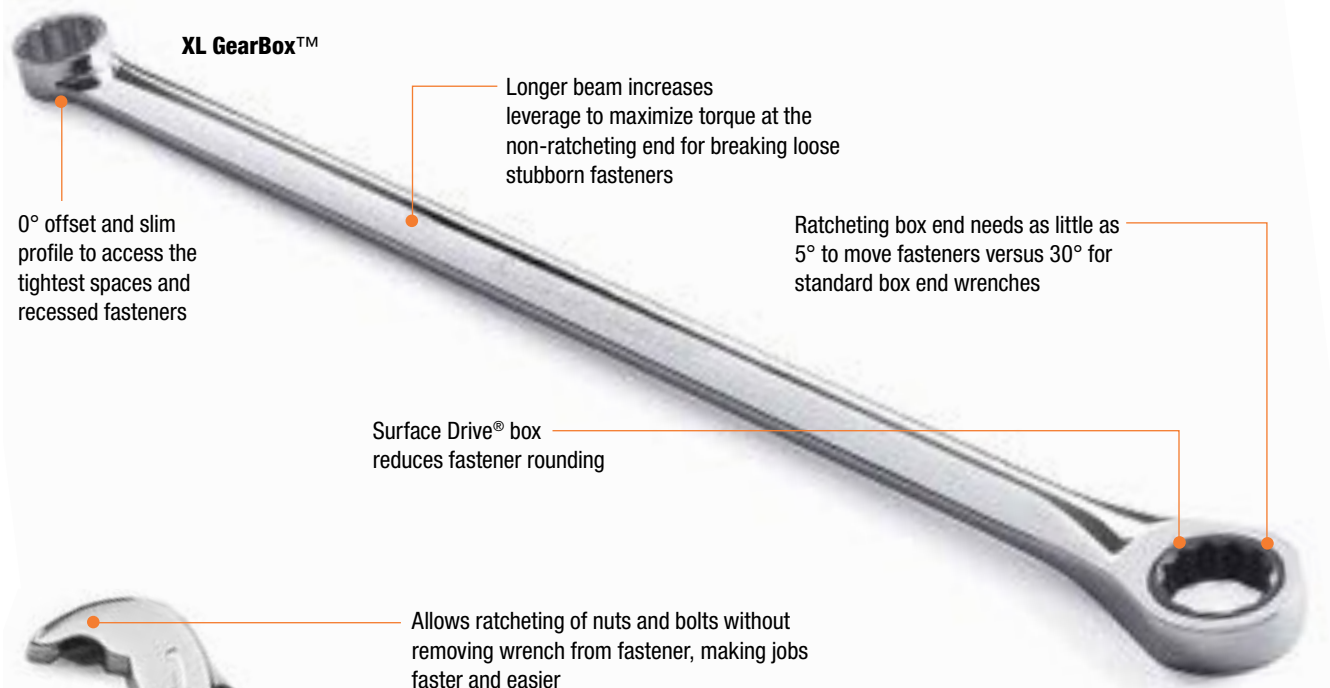

0° offset and slim profile to access the tightest spaces and recessed fasteners

XL GearBox™

Longer beam increases leverage to maximize torque at the non-ratcheting end for breaking loose stubborn fasteners

Ratcheting box end needs as little as 5° to move fasteners versus 30° for standard box end wrenches

Surface Drive® box reduces fastener rounding

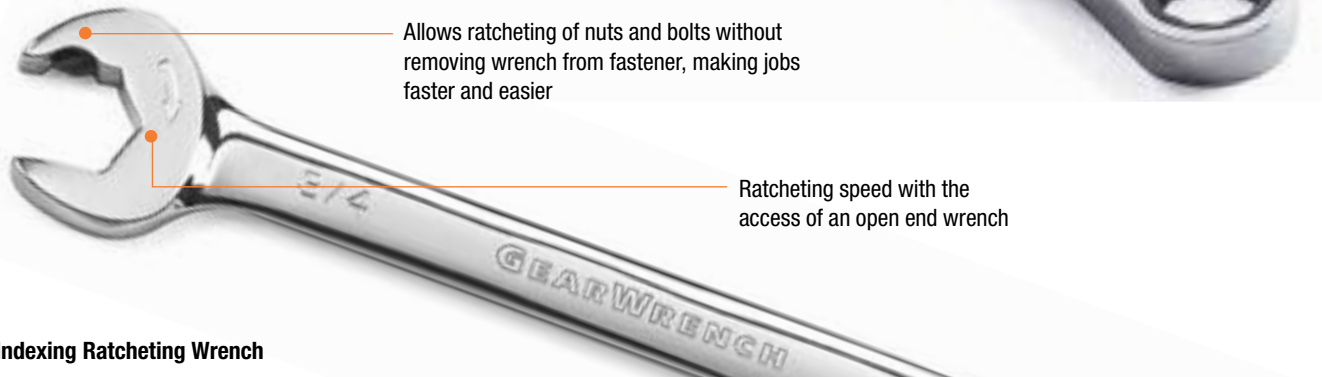

Allows ratcheting of nuts and bolts without removing wrench from fastener, making jobs faster and easier

Ratcheting speed with the access of an open end wrench

Indexing Ratcheting Wrench

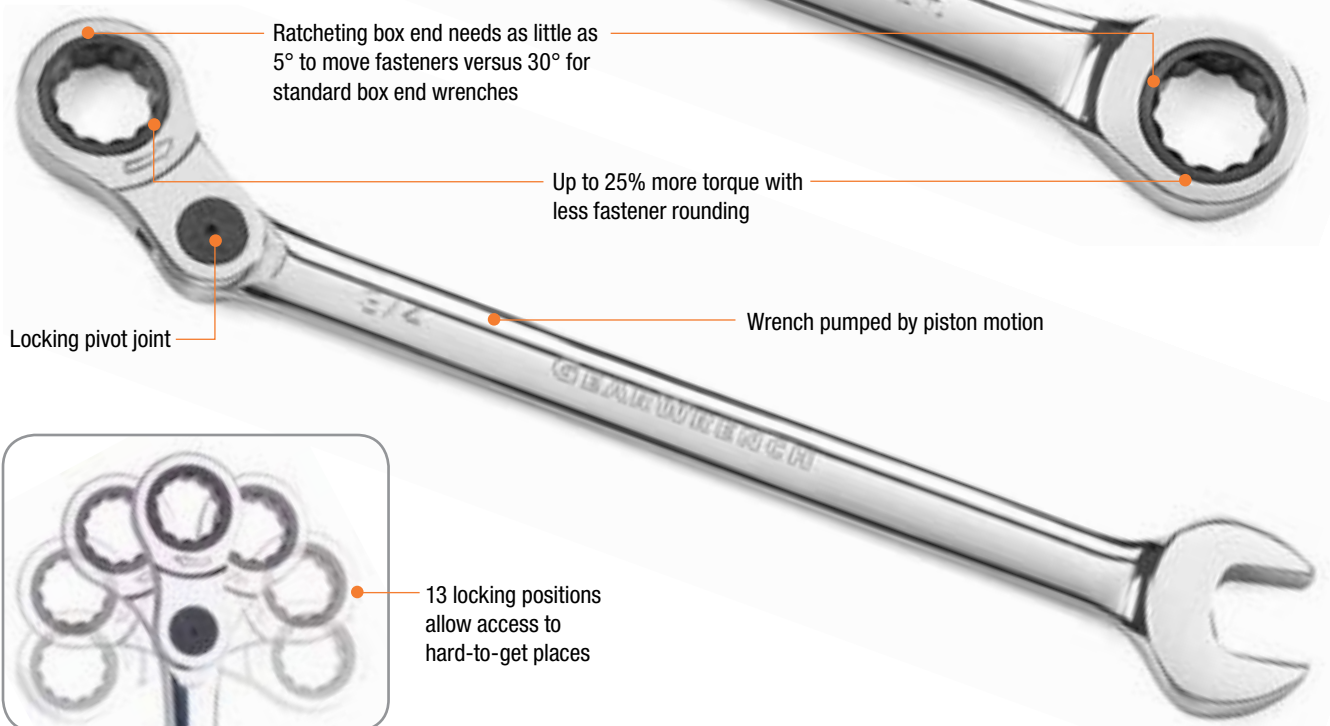

Ratcheting box end needs as little as 5° to move fasteners versus 30° for standard box end wrenches

Up to 25% more torque with less fastener rounding

Wrench pumped by piston motion

Locking pivot joint

13 locking positions allow access to hard-to-get places



Products are covered by one or more of the following patents:
 • US 5,636,557 US 6,629,477 US 6,918,477 US 7,131,356 US 7,000,507
 US 7,165,480 US 6,868,709 US 7,231,851 US 6,840,141

GEARWRENCH® 12 Pc. 12 Point Metric XL X-Beam™ Ratcheting Combination Wrench Set

- Patented, Award Winning Design
- X-Beam™ Design has over 500% More Surface Area, Enabling More Force and Less Hand Fatigue
- One Piece Forged Beam Design - No Metal Twisting or Weak Spots
- Up to 25% Longer to Access Hard-to-Reach Fasteners
- Surface Drive® on Box End Provides Off-Corner Loading for Better Grip and Reduced Fastener Rounding



Cat. No.	UPC No.	Packaging	Product Weight
85888	082171858888	Blow Mold Tray	4.12 lb

Cat. No.	Description	Cat. No.	Description
85808	8mm XL X-Beam™ Combination Ratcheting Wrench	85814	14mm XL X-Beam™ Combination Ratcheting Wrench
85809	9mm XL X-Beam™ Combination Ratcheting Wrench	85815	15mm XL X-Beam™ Combination Ratcheting Wrench
85810	10mm XL X-Beam™ Combination Ratcheting Wrench	85816	16mm XL X-Beam™ Combination Ratcheting Wrench
85811	11mm XL X-Beam™ Combination Ratcheting Wrench	85817	17mm XL X-Beam™ Combination Ratcheting Wrench
85812	12mm XL X-Beam™ Combination Ratcheting Wrench	85818	18mm XL X-Beam™ Combination Ratcheting Wrench
85813	13mm XL X-Beam™ Combination Ratcheting Wrench	85819	19mm XL X-Beam™ Combination Ratcheting Wrench

GEARWRENCH® 9 Pc. 12 Point SAE XL X-Beam™ Ratcheting Combination Wrench Set

- Patented, Award Winning Design
- X-Beam™ Design has over 500% More Surface Area, Enabling More Force and Less Hand Fatigue
- One Piece Forged Beam Design - No Metal Twisting or Weak Spots
- Up to 25% Longer to Access Hard-to-Reach Fasteners
- Surface Drive® on Box End Provides Off-Corner Loading for Better Grip and Reduced Fastener Rounding



Cat. No.	UPC No.	Packaging	Product Weight
85898	082171858987	Blow Mold Tray	2.95 lb

Cat. No.	Description	Cat. No.	Description
85850	5/16 XL X-Beam™ Combination Ratcheting Wrench"	85858	9/16 XL X-Beam™ Combination Ratcheting Wrench"
85851	11/32 XL X-Beam™ Combination Ratcheting Wrench"	85860	5/8 XL X-Beam™ Combination Ratcheting Wrench"
85852	3/8 XL X-Beam™ Combination Ratcheting Wrench"	85862	11/16 XL X-Beam™ Combination Ratcheting Wrench"
85854	7/16 XL X-Beam™ Combination Ratcheting Wrench"	85864	3/4 XL X-Beam™ Combination Ratcheting Wrench"
85856	1/2 XL X-Beam™ Combination Ratcheting Wrench"		

GEARWRENCH® 12 Pc. 12 Point Metric XL X-Beam™ Flex Combination Ratcheting Wrench Set

- Patented, Award Winning Design
- Flexible Head with Hex Head Set Screw, Not Pinned
- X-Beam™ Design Has Over 500% More Surface Area, Enabling More Force and Less Hand Fatigue
- One Piece Forged Beam Design - No Metal Twisting or Weak Spots
- Up to 25% Longer to Access Hard-to-Reach Fasteners
- Surface Drive® on Box End Provides Off-Corner Loading for Better Grip and Reduced Fastener Rounding



Cat. No.	UPC No.	Packaging	Product Weight
85288	099575852886	Blow Mold Tray	5.36 lb

Cat. No.	Description	Cat. No.	Description
85258	8mm XL X-Beam™ Flex Head Combination Ratcheting Wrench	85264	14mm XL X-Beam™ Flex Head Combination Ratcheting Wrench
85259	9mm XL X-Beam™ Flex Head Combination Ratcheting Wrench	85265	15mm XL X-Beam™ Flex Head Combination Ratcheting Wrench
85260	10mm XL X-Beam™ Flex Head Combination Ratcheting Wrench	85266	16mm XL X-Beam™ Flex Head Combination Ratcheting Wrench
85261	11mm XL X-Beam™ Flex Head Combination Ratcheting Wrench	85267	17mm XL X-Beam™ Flex Head Combination Ratcheting Wrench
85262	12mm XL X-Beam™ Flex Head Combination Ratcheting Wrench	85268	18mm XL X-Beam™ Flex Head Combination Ratcheting Wrench
85263	13mm XL X-Beam™ Flex Head Combination Ratcheting Wrench	85269	19mm XL X-Beam™ Flex Head Combination Ratcheting Wrench

GEARWRENCH® 9 Pc. 12 Point SAE XL X-Beam™ Flex Combination Ratcheting Wrench Set

- Patented, Award Winning Design
- Flexible Head with Hex Head Set Screw, Not Pinned
- X-Beam™ Design Has Over 500% More Surface Area, Enabling More Force and Less Hand Fatigue
- One Piece Forged Beam Design - No Metal Twisting or Weak Spots
- Up to 25% Longer to Access Hard-to-Reach Fasteners
- Surface Drive® on Box End Provides Off-Corner Loading for Better Grip and Reduced Fastener Rounding



Cat. No.	UPC No.	Packaging	Product Weight
85298	099575852985	Blow Mold Tray	3.93 lb

Cat. No.	Description	Cat. No.	Description
85270	5/16 XL X-Beam™ Flex Head Combination Ratcheting Wrench"	85278	9/16 XL X-Beam™ Flex Head Combination Ratcheting Wrench"
85271	11/32 XL X-Beam™ Flex Head Combination Ratcheting Wrench"	85280	5/8 XL X-Beam™ Flex Head Combination Ratcheting Wrench"
85272	3/8 XL X-Beam™ Flex Head Combination Ratcheting Wrench"	85282	11/16 XL X-Beam™ Flex Head Combination Ratcheting Wrench"
85274	7/16 XL X-Beam™ Flex Head Combination Ratcheting Wrench"	85284	3/4 XL X-Beam™ Flex Head Combination Ratcheting Wrench"
85276	1/2 XL X-Beam™ Flex Head Combination Ratcheting Wrench"		

GEARWRENCH® 12 Pc. 12 Point Metric XL X-Beam™ Reversible Combination Ratcheting Wrench Set

- Patented Award Winning Design
- Up to 25% Longer to Access Hard-To-Reach Fasteners
- X-Beam™ Allows You to Apply Force to the Flat Side of the Wrench, Reducing Hand Fatigue
- Surface Drive® on Box End Provides Off-Corner Loading for Better Grip and Reduced Fastener Rounding
- One Piece Forged Beam Design - No Metal Twisting or Weak Spots



Cat. No.	UPC No.	Packaging	Product Weight
85388	099575853883	Blow Mold Tray	5.06 lb

Cat. No.	Description	Cat. No.	Description
85308	8mm Reversible XL X-Beam™ Combination Ratcheting Wrench	85314	14mm Reversible XL X-Beam™ Combination Ratcheting Wrench
85309	9mm Reversible XL X-Beam™ Combination Ratcheting Wrench	85315	15mm Reversible XL X-Beam™ Combination Ratcheting Wrench
85310D	10mm Reversible XL X-Beam™ Combination Ratcheting Wrench	85316	16mm Reversible XL X-Beam™ Combination Ratcheting Wrench
85311	11mm Reversible XL X-Beam™ Combination Ratcheting Wrench	85317	17mm Reversible XL X-Beam™ Combination Ratcheting Wrench
85312D	12mm Reversible XL X-Beam™ Combination Ratcheting Wrench	85318	18mm Reversible XL X-Beam™ Combination Ratcheting Wrench
85313	13mm Reversible XL X-Beam™ Combination Ratcheting Wrench	85319D	19mm Reversible XL X-Beam™ Combination Ratcheting Wrench

GEARWRENCH® 9 Pc. 12 Point SAE XL X-Beam™ Reversible Combination Ratcheting Wrench Set

- Patented Award Winning Design
- Up to 25% Longer to Access Hard-To-Reach Fasteners
- X-Beam™ Allows You to Apply Force to the Flat Side of the Wrench, Reducing Hand Fatigue
- Surface Drive® on Box End Provides Off-Corner Loading for Better Grip and Reduced Fastener Rounding
- One Piece Forged Beam Design - No Metal Twisting or Weak Spots



Cat. No.	UPC No.	Packaging	Product Weight
85398	099575853982	Blow Mold Tray	3.84 lb

Cat. No.	Description	Cat. No.	Description
85360	5/16 Reversible XL X-Beam™ Combination Ratcheting Wrench	85368	9/16 Reversible XL X-Beam™ Combination Ratcheting Wrench
85361	11/32 Reversible XL X-Beam™ Combination Ratcheting Wrench	85370	5/8 Reversible XL X-Beam™ Combination Ratcheting Wrench
85362	3/8 Reversible XL X-Beam™ Combination Ratcheting Wrench	85372	11/16 Reversible XL X-Beam™ Combination Ratcheting Wrench
85364	7/16 Reversible XL X-Beam™ Combination Ratcheting Wrench	85374	3/4 Reversible XL X-Beam™ Combination Ratcheting Wrench
85366	1/2 Reversible XL X-Beam™ Combination Ratcheting Wrench		

GEARWRENCH® 12 Point SAE XL X-Beam™ Ratcheting Combination Wrenches

- Patented, Award Winning Design
- X-Beam™ Design Has Over 500% More Surface Area, Enabling More Force and Less Hand Fatigue
- One Piece Forged Beam Design - No Metal Twisting or Weak Spots
- Up to 25% Longer to Access Hard-to-Reach Fasteners
- Surface Drive® on Box End Provides Off-Corner Loading for Better Grip and Reduced Fastener Rounding



Cat. No.	UPC No.	Packaging	Fastener Size	End A Width	End A Thickness	End B Width	End B Thickness	Overall Length	Product Weight
85850	082171858505	Carded	5/16 in	0.770 in	0.200 in	0.670 in	0.270 in	5.910 in	0.09 lb
85851	082171858512	Carded	11/32 in	0.770 in	0.210 in	0.700 in	0.270 in	6.500 in	0.11 lb
85852	082171858529	Carded	3/8 in	0.860 in	0.220 in	0.780 in	0.300 in	7.090 in	0.13 lb
85854	082171858543	Carded	7/16 in	0.950 in	0.250 in	0.850 in	0.320 in	7.680 in	0.17 lb
85856	082171858567	Carded	1/2 in	1.150 in	0.320 in	0.980 in	0.340 in	8.660 in	0.25 lb
85858	082171858581	Carded	9/16 in	1.230 in	0.330 in	1.040 in	0.370 in	9.250 in	0.29 lb
85860	082171858604	Carded	5/8 in	1.360 in	0.350 in	1.200 in	0.410 in	10.240 in	0.41 lb
85862	082171858628	Carded	11/16 in	1.490 in	0.360 in	1.270 in	0.420 in	10.830 in	0.53 lb
85864	082171858642	Carded	3/4 in	1.630 in	0.370 in	1.340 in	0.440 in	12.010 in	0.65 lb

GEARWRENCH® 12 Point Metric XL X-Beam™ Ratcheting Combination Wrenches

- Patented, Award Winning Design
- X-Beam™ Design Has Over 500% More Surface Area, Enabling More Force and Less Hand Fatigue
- One Piece Forged Beam Design - No Metal Twisting or Weak Spots
- Up to 25% Longer to Access Hard-to-Reach Fasteners
- Surface Drive® on Box End Provides Off-Corner Loading for Better Grip and Reduced Fastener Rounding



Cat. No.	UPC No.	Packaging	Fastener Size	End A Width	End A Thickness	End B Width	End B Thickness	Overall Length	Product Weight
85808	082171858086	Carded	8 mm	0.770 in	0.200 in	0.670 in	0.270 in	5.910 in	0.09 lb
85809	082171858093	Carded	9 mm	0.770 in	0.210 in	0.700 in	0.270 in	6.500 in	0.11 lb
85810	082171858109	Carded	10 mm	0.860 in	0.220 in	0.780 in	0.300 in	7.090 in	0.13 lb
85811	082171858116	Carded	11 mm	0.950 in	0.250 in	0.850 in	0.320 in	7.680 in	0.13 lb
85812	082171858123	Carded	12 mm	1.050 in	0.290 in	0.910 in	0.340 in	8.150 in	0.15 lb
85813	082171858130	Carded	13 mm	1.150 in	0.320 in	0.980 in	0.340 in	8.660 in	0.17 lb
85814	082171858147	Carded	14 mm	1.230 in	0.330 in	1.040 in	0.370 in	9.250 in	0.21 lb
85815	082171858154	Carded	15 mm	1.330 in	0.330 in	1.130 in	0.390 in	9.840 in	0.25 lb
85816	082171858161	Carded	16 mm	1.360 in	0.350 in	1.200 in	0.410 in	10.240 in	0.29 lb
85817	082171858178	Carded	17 mm	1.490 in	0.360 in	1.270 in	0.420 in	10.830 in	0.33 lb
85818	082171858185	Carded	18 mm	1.580 in	0.370 in	1.310 in	0.440 in	11.420 in	0.41 lb
85819	082171858192	Carded	19 mm	1.630 in	0.370 in	1.340 in	0.440 in	12.010 in	0.46 lb

GEARWRENCH® 12 Point SAE XL X-Beam™ Reversible Combination Ratcheting Wrenches

- Patented Award Winning Design
- Up to 25% Longer to Access Hard-To-Reach Fasteners
- X-Beam™ Allows You to Apply Force to the Flat Side of the Wrench, Reducing Hand Fatigue
- Surface Drive® on Box End Provides Off-Corner Loading for Better Grip and Reduced Fastener Rounding
- One Piece Forged Beam Design - No Metal Twisting or Weak Spots



Cat. No.	UPC No.	Packaging	Fastener Size	End A Width	End A Thickness	End B Width	End B Thickness	Overall Length	Product Weight
85360	099575853609	Carded	5/16 in	0.770 in	0.200 in	0.670 in	0.270 in	5.910 in	0.09 lb
85361	099575853616	Carded	11/32 in	0.770 in	0.210 in	0.700 in	0.270 in	6.500 in	0.11 lb
85362	099575853623	Carded	3/8 in	0.860 in	0.220 in	0.780 in	0.300 in	7.090 in	0.15 lb
85364	099575853647	Carded	7/16 in	0.950 in	0.250 in	0.850 in	0.320 in	7.680 in	0.19 lb
85366	099575853661	Carded	1/2 in	1.150 in	0.320 in	0.980 in	0.340 in	8.660 in	0.26 lb
85368	099575853685	Carded	9/16 in	1.230 in	0.330 in	1.040 in	0.370 in	9.250 in	0.31 lb
85370	099575853708	Carded	5/8 in	1.360 in	0.350 in	1.200 in	0.410 in	10.240 in	0.45 lb
85372	099575853722	Carded	11/16 in	1.490 in	0.360 in	1.270 in	0.420 in	10.830 in	0.54 lb
85374	099575853746	Carded	3/4 in	1.630 in	0.370 in	1.340 in	0.440 in	12.010 in	0.66 lb

GEARWRENCH® 12 Point Metric XL X-Beam™ Reversible Combination Ratcheting Wrenches

- Patented Award Winning Design
- Up to 25% Longer to Access Hard-To-Reach Fasteners
- X-Beam™ Allows You to Apply Force to the Flat Side of the Wrench, Reducing Hand Fatigue
- Surface Drive® on Box End Provides Off-Corner Loading for Better Grip and Reduced Fastener Rounding
- One Piece Forged Beam Design - No Metal Twisting or Weak Spots



Cat. No.	UPC No.	Packaging	Fastener Size	End A Width	End A Thickness	End B Width	End B Thickness	Overall Length	Product Weight
85308	099575853081	Carded	8 mm	0.770 in	0.200 in	0.670 in	0.270 in	5.910 in	0.09 lb
85309	099575853098	Carded	9 mm	0.770 in	0.210 in	0.700 in	0.270 in	6.500 in	0.11 lb
85310D	099575853104	Carded	10 mm	0.860 in	0.220 in	0.780 in	0.300 in	7.090 in	0.15 lb
85311	099575853111	Carded	11 mm	0.950 in	0.250 in	0.850 in	0.320 in	7.680 in	0.19 lb
85312D	099575853128	Carded	12 mm	1.050 in	0.290 in	0.910 in	0.340 in	8.150 in	0.22 lb
85313	099575853135	Carded	13 mm	1.150 in	0.320 in	0.980 in	0.340 in	8.660 in	0.26 lb
85314	099575853142	Carded	14 mm	1.230 in	0.330 in	1.040 in	0.370 in	9.250 in	0.31 lb
85315	099575853159	Carded	15 mm	1.330 in	0.330 in	1.130 in	0.390 in	9.840 in	0.40 lb
85316	099575853166	Carded	16 mm	1.360 in	0.350 in	1.200 in	0.410 in	10.240 in	0.45 lb
85317	099575853173	Carded	17 mm	1.490 in	0.360 in	1.270 in	0.420 in	10.830 in	0.54 lb
85318	099575853180	Carded	18 mm	1.580 in	0.370 in	1.310 in	0.440 in	11.420 in	0.58 lb
85319D	099575853197	Carded	19 mm	1.630 in	0.370 in	1.340 in	0.440 in	12.010 in	0.66 lb

GEARWRENCH® 12 Point SAE XL X-Beam™ Flex Combination Ratcheting Wrenches

- Patented, Award Winning Design
- Flexible Head with Hex Head Set Screw, Not Pinned
- X-Beam™ Design Has Over 500% More Surface Area, Enabling More Force and Less Hand Fatigue
- One Piece Forged Beam Design - No Metal Twisting or Weak Spots
- Up to 25% Longer to Access Hard-to-Reach Fasteners
- Surface Drive® on Box End Provides Off-Corner Loading for Better Grip and Reduced Fastener Rounding



Cat. No.	UPC No.	Packaging	Fastener Size	End A Width	End A Thickness	End B Width	End B Thickness	Overall Length	Product Weight
85270	099575852701	Carded	5/16 in	0.770 in	0.200 in	0.670 in	0.270 in	5.910 in	0.11 lb
85271	099575852718	Carded	11/32 in	0.770 in	0.210 in	0.700 in	0.270 in	6.500 in	0.13 lb
85272	099575852725	Carded	3/8 in	0.860 in	0.220 in	0.780 in	0.300 in	7.090 in	0.18 lb
85274	099575852749	Carded	7/16 in	0.950 in	0.250 in	0.850 in	0.320 in	7.680 in	0.22 lb
85276	099575852763	Carded	1/2 in	1.150 in	0.320 in	0.980 in	0.340 in	8.660 in	0.28 lb
85278	099575852787	Carded	9/16 in	1.230 in	0.330 in	1.040 in	0.370 in	9.250 in	0.36 lb
85280	099575852800	Carded	5/8 in	1.360 in	0.350 in	1.200 in	0.410 in	10.240 in	0.48 lb
85282	099575852824	Carded	11/16 in	1.490 in	0.360 in	1.270 in	0.420 in	10.830 in	0.57 lb
85284	099575852848	Carded	3/4 in	1.630 in	0.370 in	1.340 in	0.440 in	12.010 in	0.75 lb

GEARWRENCH® 12 Point Metric XL X-Beam™ Flex Combination Ratcheting Wrenches

- Patented, Award Winning Design
- Flexible Head with Hex Head Set Screw, Not Pinned
- X-Beam™ Design Has Over 500% More Surface Area, Enabling More Force and Less Hand Fatigue
- One Piece Forged Beam Design - No Metal Twisting or Weak Spots
- Up to 25% Longer to Access Hard-to-Reach Fasteners
- Surface Drive® on Box End Provides Off-Corner Loading for Better Grip and Reduced Fastener Rounding



Cat. No.	UPC No.	Packaging	Fastener Size	End A Width	End A Thickness	End B Width	End B Thickness	Overall Length	Product Weight
85258	099575852589	Carded	8 mm	0.770 in	0.200 in	0.670 in	0.270 in	5.910 in	0.11 lb
85259	099575852596	Carded	9 mm	0.770 in	0.210 in	0.700 in	0.270 in	6.500 in	0.14 lb
85260	099575852602	Carded	10 mm	0.860 in	0.220 in	0.780 in	0.300 in	7.090 in	0.17 lb
85261	099575852619	Carded	11 mm	0.950 in	0.250 in	0.850 in	0.320 in	7.680 in	0.21 lb
85262	099575852626	Carded	12 mm	1.050 in	0.290 in	0.910 in	0.340 in	8.150 in	0.22 lb
85263	099575852633	Carded	13 mm	1.150 in	0.320 in	0.980 in	0.340 in	8.660 in	0.28 lb
85264	099575852640	Carded	14 mm	1.230 in	0.330 in	1.040 in	0.370 in	9.250 in	0.36 lb
85265	099575852657	Carded	15 mm	1.330 in	0.330 in	1.130 in	0.390 in	9.840 in	0.39 lb
85266	099575852664	Carded	16 mm	1.360 in	0.350 in	1.200 in	0.410 in	10.240 in	0.47 lb
85267	099575852671	Carded	17 mm	1.490 in	0.360 in	1.270 in	0.420 in	10.830 in	0.57 lb
85268	099575852688	Carded	18 mm	1.580 in	0.370 in	1.310 in	0.440 in	11.420 in	0.62 lb
85269	099575852695	Carded	19 mm	1.630 in	0.370 in	1.340 in	0.440 in	12.010 in	0.74 lb

GEARWRENCH® 16 Pc. 12 Point Metric XL Combination Ratcheting Wrench Set with V Rack

- XL Combination 20% Longer and 25% Stronger
- Ratcheting Box End Needs As Little As 5° to Move Fasteners vs. 30° for Standard Wrenches
- Bright, Full Polish Chrome Finish
- Surface Drive® on Box End Provides Off-Corner Loading for Better Grip and Reduced Fastener Rounding



Cat. No.	UPC No.	Packaging	Product Weight
85099	082171850998	Carded	8.26 lb

Cat. No.	Description	Cat. No.	Description
85008D	8mm XL Ratcheting Combination Wrench	85016	16mm XL Ratcheting Combination Wrench
85009	9mm XL Ratcheting Combination Wrench	85017	17mm XL Ratcheting Combination Wrench
85010	10mm XL Ratcheting Combination Wrench	85018	18mm XL Ratcheting Combination Wrench
85011	11mm XL Ratcheting Combination Wrench	85019	19mm XL Ratcheting Combination Wrench
85012	12mm XL Ratcheting Combination Wrench	85020	20mm XL Ratcheting Combination Wrench
85013D	13mm XL Ratcheting Combination Wrench	85021	21mm XL Ratcheting Combination Wrench
85014	14mm XL Ratcheting Combination Wrench	85022	22mm XL Ratcheting Combination Wrench
85015	15mm XL Ratcheting Combination Wrench	85024D	24mm XL Ratcheting Combination Wrench

GEARWRENCH® 16 Pc. 12 Point Metric XL Combination Ratcheting Wrench Set with Wrench Roll

- XL Combination 20% Longer and 25% Stronger
- Ratcheting Box End Needs As Little As 5° to Move Fasteners vs. 30° for Standard Wrenches
- Bright, Full Polish Chrome Finish
- Surface Drive® on Box End Provides Off-Corner Loading for Better Grip and Reduced Fastener Rounding



Cat. No.	UPC No.	Packaging	Product Weight
85099R	082171850929	Boxed	8.64 lb

Cat. No.	Description	Cat. No.	Description
85008D	8mm XL Ratcheting Combination Wrench	85016	16mm XL Ratcheting Combination Wrench
85009	9mm XL Ratcheting Combination Wrench	85017	17mm XL Ratcheting Combination Wrench
85010	10mm XL Ratcheting Combination Wrench	85018	18mm XL Ratcheting Combination Wrench
85011	11mm XL Ratcheting Combination Wrench	85019	19mm XL Ratcheting Combination Wrench
85012	12mm XL Ratcheting Combination Wrench	85020	20mm XL Ratcheting Combination Wrench
85013D	13mm XL Ratcheting Combination Wrench	85021	21mm XL Ratcheting Combination Wrench
85014	14mm XL Ratcheting Combination Wrench	85022	22mm XL Ratcheting Combination Wrench
85015	15mm XL Ratcheting Combination Wrench	85024D	24mm XL Ratcheting Combination Wrench

GEARWRENCH® 13 Pc. 12 Point SAE XL Combination Ratcheting Wrench Set with V Rack

- XL Combination 20% Longer and 25% Stronger
- Ratcheting Box End Needs as Little As 5° to Move Fasteners vs. 30° for Standard Wrenches
- Bright, Full Polish Chrome Finish
- Surface Drive® on Box End Provides Off-Corner Loading for Better Grip and Reduced Fastener Rounding



Cat. No.	UPC No.	Packaging	Product Weight
85199	082171851995	Carded	7.62 lb

Cat. No.	Description	Cat. No.	Description
85108	1/4" XL Ratcheting Combination Wrench	85122D	11/16" XL Ratcheting Combination Wrench
85110	5/16" XL Ratcheting Combination Wrench	85124D	3/4" XL Ratcheting Combination Wrench
85112	3/8" XL Ratcheting Combination Wrench	85126	13/16" XL Ratcheting Combination Wrench
85114	7/16" XL Ratcheting Combination Wrench	85128	7/8" XL Ratcheting Combination Wrench
85116	1/2" XL Ratcheting Combination Wrench	85130	15/16" XL Ratcheting Combination Wrench
85118	9/16" XL Ratcheting Combination Wrench	85132	1" XL Ratcheting Combination Wrench
85120D	5/8" XL Ratcheting Combination Wrench		

GEARWRENCH® 13 Pc. 12 Point SAE XL Combination Ratcheting Wrench Set with Wrench Roll

- XL Combination 20% Longer and 25% Stronger
- Ratcheting Box End Needs As Little As 5° to Move Fasteners vs. 30° for Standard Wrenches
- Bright, Full Polish Chrome Finish
- Surface Drive® on Box End Provides Off-Corner Loading for Better Grip and Reduced Fastener Rounding



Cat. No.	UPC No.	Packaging	Product Weight
85199R	082171851919	Boxed	3.65 lb

Cat. No.	Description	Cat. No.	Description
85108	1/4" XL Ratcheting Combination Wrench	85122D	11/16" XL Ratcheting Combination Wrench
85110	5/16" XL Ratcheting Combination Wrench	85124D	3/4" XL Ratcheting Combination Wrench
85112	3/8" XL Ratcheting Combination Wrench	85126	13/16" XL Ratcheting Combination Wrench
85114	7/16" XL Ratcheting Combination Wrench	85128	7/8" XL Ratcheting Combination Wrench
85116	1/2" XL Ratcheting Combination Wrench	85130	15/16" XL Ratcheting Combination Wrench
85118	9/16" XL Ratcheting Combination Wrench	85132	1" XL Ratcheting Combination Wrench
85120D	5/8" XL Ratcheting Combination Wrench		

GEARWRENCH® 12 Pc. 12 Point Metric XL Combination Ratcheting Wrench Set with V Rack

- XL Combination 20% Longer and 25% Stronger
- Ratcheting Box End Needs As Little As 5° to Move Fasteners vs. 30° for Standard Wrenches
- Bright, Full Polish Chrome Finish
- Surface Drive® on Box End Provides Off-Corner Loading for Better Grip and Reduced Fastener Rounding



Cat. No.	UPC No.	Packaging	Product Weight
85098	082171850981	Carded	4.12 lb

Cat. No.	Description	Cat. No.	Description
85008D	8mm XL Ratcheting Combination Wrench	85014	14mm XL Ratcheting Combination Wrench
85009	9mm XL Ratcheting Combination Wrench	85015	15mm XL Ratcheting Combination Wrench
85010	10mm XL Ratcheting Combination Wrench	85016	16mm XL Ratcheting Combination Wrench
85011	11mm XL Ratcheting Combination Wrench	85017	17mm XL Ratcheting Combination Wrench
85012	12mm XL Ratcheting Combination Wrench	85018	18mm XL Ratcheting Combination Wrench
85013D	13mm XL Ratcheting Combination Wrench	85019	19mm XL Ratcheting Combination Wrench

GEARWRENCH® 10 Pc. 12 Point Metric XL Combination Ratcheting Wrench Set with Wrench Roll

- XL Combination 20% Longer and 25% Stronger
- Ratcheting Box End Needs As Little as 5° to Move Fasteners vs. 30° for Standard Wrenches
- Bright, Full Polish Chrome Finish
- Surface Drive® on Box End Provides Off-Corner Loading for Better Grip and Reduced Fastener Rounding



Cat. No.	UPC No.	Packaging	Product Weight
85090R	082171850905	Boxed	3.45 lb

Cat. No.	Description	Cat. No.	Description
85010	10mm XL Ratcheting Combination Wrench	85015	15mm XL Ratcheting Combination Wrench
85011	11mm XL Ratcheting Combination Wrench	85016	16mm XL Ratcheting Combination Wrench
85012	12mm XL Ratcheting Combination Wrench	85017	17mm XL Ratcheting Combination Wrench
85013D	13mm XL Ratcheting Combination Wrench	85018	18mm XL Ratcheting Combination Wrench
85014	14mm XL Ratcheting Combination Wrench	85019	19mm XL Ratcheting Combination Wrench

GEARWRENCH® 8 Pc. 12 Point SAE XL Combination Ratcheting Wrench Set with V Rack

- XL Combination 20% Longer and 25% Stronger
- Ratcheting Box End Needs As Little As 5° to Move Fasteners vs. 30° for Standard Wrenches
- Bright, Full Polish Chrome Finish
- Surface Drive® on Box End Provides Off-Corner Loading for Better Grip and Reduced Fastener Rounding



Cat. No.	UPC No.	Packaging	Product Weight
85198	082171851988	Carded	3.12 lb

Cat. No.	Description	Cat. No.	Description
85110	5/16" XL Ratcheting Combination Wrench	85118	9/16" XL Ratcheting Combination Wrench
85112	3/8" XL Ratcheting Combination Wrench	85120D	5/8" XL Ratcheting Combination Wrench
85114	7/16" XL Ratcheting Combination Wrench	85122D	11/16" XL Ratcheting Combination Wrench
85116	1/2" XL Ratcheting Combination Wrench	85124D	3/4" XL Ratcheting Combination Wrench

GEARWRENCH® 7 Pc. 12 Point SAE XL Combination Ratcheting Wrench Set with Wrench Roll

- XL Combination 20% Longer and 25% Stronger
- Ratcheting Box End Needs As Little As 5° to Move Fasteners vs. 30° for Standard Wrenches
- Bright, Full Polish Chrome Finish
- Surface Drive® on Box End Provides Off-Corner Loading for Better Grip and Reduced Fastener Rounding



Cat. No.	UPC No.	Packaging	Product Weight
85197R	082171851971	Boxed	3.25 lb

Cat. No.	Description	Cat. No.	Description
85112	3/8" XL Ratcheting Combination Wrench	85120D	5/8" XL Ratcheting Combination Wrench
85114	7/16" XL Ratcheting Combination Wrench	85122D	11/16" XL Ratcheting Combination Wrench
85116	1/2" XL Ratcheting Combination Wrench	85124D	3/4" XL Ratcheting Combination Wrench
85118	9/16" XL Ratcheting Combination Wrench		

GEARWRENCH® 12 Point SAE XL Combination Ratcheting Wrenches

- XL Combination 20% Longer and 25% Stronger
- Ratcheting Box End Needs As Little As 5° to Move Fasteners vs. 30° for Standard Wrenches
- Surface Drive® on Box End Provides Off-Corner Loading for Better Grip and Reduced Fastener Rounding



Cat. No.	UPC No.	Packaging	Fastener Size	End A Width	End A Thickness	End B Width	End B Thickness	Overall Length	Product Weight
85108	082171851087	Carded	1/4 in	0.570 in	0.180 in	0.610 in	0.260 in	5.310 in	0.09 lb
85110	082171851100	Carded	5/16 in	0.770 in	0.200 in	0.670 in	0.270 in	5.910 in	0.12 lb
85112	082171851124	Carded	3/8 in	0.860 in	0.220 in	0.780 in	0.300 in	7.090 in	0.17 lb
85114	082171851148	Carded	7/16 in	0.950 in	0.250 in	0.850 in	0.320 in	7.680 in	0.20 lb
85116	082171851162	Carded	1/2 in	1.150 in	0.320 in	0.980 in	0.340 in	8.660 in	0.30 lb
85118	082171851186	Carded	9/16 in	1.230 in	0.330 in	1.040 in	0.370 in	9.250 in	0.38 lb
85120D	082171851209	Carded	5/8 in	1.360 in	0.350 in	1.200 in	0.410 in	10.240 in	0.43 lb
85122D	082171851223	Carded	11/16 in	1.490 in	0.360 in	1.270 in	0.420 in	10.830 in	0.49 lb
85124D	082171851247	Carded	3/4 in	1.630 in	0.370 in	1.340 in	0.440 in	12.010 in	0.76 lb
85126	082171851261	Carded	13/16 in	1.770 in	0.400 in	1.540 in	0.510 in	12.510 in	0.95 lb
85128	082171851285	Carded	7/8 in	1.870 in	0.420 in	1.540 in	0.510 in	13.000 in	1.01 lb
85130	082171851308	Carded	15/16 in	2.010 in	0.440 in	1.750 in	0.570 in	14.000 in	1.25 lb
85132	082171851322	Carded	1 in	2.090 in	0.460 in	1.750 in	0.570 in	14.500 in	1.39 lb

GEARWRENCH® 12 Point Metric XL Combination Ratcheting Wrenches

- XL Combination 20% Longer and 25% Stronger
- Ratcheting Box End Needs As Little As 5° to Move Fasteners vs. 30° for Standard Wrenches
- Surface Drive® on Box End Provides Off-Corner Loading for Better Grip and Reduced Fastener Rounding



Cat. No.	UPC No.	Packaging	Fastener Size	End A Width	End A Thickness	End B Width	End B Thickness	Overall Length	Product Weight
85007	082171850073	Carded	7 mm	0.640 in	0.190 in	0.620 in	0.260 in	5.610 in	0.09 lb
85008D	082171850080	Carded	8 mm	0.770 in	0.200 in	0.670 in	0.270 in	5.910 in	0.12 lb
85009	082171850097	Carded	9 mm	0.770 in	0.210 in	0.700 in	0.270 in	6.500 in	0.14 lb
85010	082171850103	Carded	10 mm	0.860 in	0.220 in	0.780 in	0.300 in	7.090 in	0.16 lb
85011	082171850110	Carded	11 mm	0.950 in	0.250 in	0.850 in	0.320 in	7.680 in	0.20 lb
85012	082171850127	Carded	12 mm	1.050 in	0.290 in	0.910 in	0.340 in	8.150 in	0.23 lb
85013D	082171850134	Carded	13 mm	1.150 in	0.320 in	0.980 in	0.340 in	8.660 in	0.31 lb
85014	082171850141	Carded	14 mm	1.230 in	0.330 in	1.040 in	0.370 in	9.250 in	0.36 lb
85015	082171850158	Carded	15 mm	1.330 in	0.330 in	1.130 in	0.390 in	9.840 in	0.41 lb
85016	082171850165	Carded	16 mm	1.360 in	0.350 in	1.200 in	0.410 in	10.240 in	0.50 lb
85017	082171850172	Carded	17 mm	1.490 in	0.360 in	1.270 in	0.420 in	10.830 in	0.55 lb
85018	082171850189	Carded	18 mm	1.580 in	0.370 in	1.310 in	0.440 in	11.420 in	0.65 lb
85019	082171850196	Carded	19 mm	1.630 in	0.370 in	1.340 in	0.440 in	12.010 in	0.72 lb
85020	082171850202	Carded	20 mm	1.770 in	0.400 in	1.540 in	0.510 in	12.510 in	0.99 lb
85021	082171850219	Carded	21 mm	1.770 in	0.400 in	1.540 in	0.510 in	12.510 in	1.08 lb
85022	082171850226	Carded	22 mm	1.870 in	0.420 in	1.540 in	0.510 in	13.000 in	1.14 lb
85024D	082171850240	Carded	24 mm	2.010 in	0.440 in	1.750 in	0.570 in	14.000 in	1.24 lb

GEARWRENCH® 16 Pc. 12 Point Metric Combination Ratcheting Wrench Set

- Ratcheting Box End Needs As Little As 5° to Move Fasteners vs. 30° for Standard Wrenches
- Bright, Full Polish Chrome Finish
- The Original Patented Ratcheting Wrench
- Surface Drive® on Box End Provides Off-Corner Loading for Better Grip and Reduced Fastener Rounding



Cat. No.	UPC No.	Packaging	Product Weight
9416	082171094163	Carded	6.67 lb

Cat. No.	Description	Cat. No.	Description
9108D	8mm Combination Ratcheting Wrench	9116D	16mm Combination Ratcheting Wrench
9109	9mm Combination Ratcheting Wrench	9117D	17mm Combination Ratcheting Wrench
9110D	10mm Combination Ratcheting Wrench	9118D	18mm Combination Ratcheting Wrench
9111	11mm Combination Ratcheting Wrench	9119	19mm Combination Ratcheting Wrench
9112	12mm Combination Ratcheting Wrench	9120	20mm Combination Ratcheting Wrench
9113D	13mm Combination Ratcheting Wrench	9121	21mm Combination Ratcheting Wrench
9114D	14mm Combination Ratcheting Wrench	9122	22mm Combination Ratcheting Wrench
9115D	15mm Combination Ratcheting Wrench	9124	24mm Combination Ratcheting Wrench

GEARWRENCH® 13 Pc. 12 Point SAE Combination Ratcheting Wrench Set

- Ratcheting Box End Needs As Little As 5° to Move Fasteners vs. 30° for Standard Wrenches
- Bright, Full Polish Chrome Finish
- The Original Patented Ratcheting Wrench
- Surface Drive® on Box End Provides Off-Corner Loading for Better Grip and Reduced Fastener Rounding



Cat. No.	UPC No.	Packaging	Product Weight
9312	082171093128	Carded	5.96 lb

Cat. No.	Description	Cat. No.	Description
9008	1/4" Combination Ratcheting Wrench	9022	11/16" Combination Ratcheting Wrench
9010D	5/16" Combination Ratcheting Wrench	9024	3/4" Combination Ratcheting Wrench
9012D	3/8" Combination Ratcheting Wrench	9026D	13/16" Combination Ratcheting Wrench
9014	7/16" Combination Ratcheting Wrench	9028D	7/8" Combination Ratcheting Wrench
9016D	1/2" Combination Ratcheting Wrench	9030	15/16" Combination Ratcheting Wrench
9018D	9/16" Combination Ratcheting Wrench	9032	1" Combination Ratcheting Wrench
9020	5/8" Combination Ratcheting Wrench		

GEARWRENCH® 12 Pc. 12 Point Metric Combination Ratcheting Wrench Set

- Ratcheting Box End Needs As Little As 5° to Move Fasteners vs. 30° for Standard Wrenches
- Bright, Full Polish Chrome Finish
- The Original Patented Ratcheting Wrench
- Surface Drive® on Box End Provides Off-Corner Loading for Better Grip and Reduced Fastener Rounding



Cat. No.	UPC No.	Packaging	Product Weight
9412	082171094125	Blow Mold Tray	3.56 lb

Cat. No.	Description	Cat. No.	Description
9108D	8mm Combination Ratcheting Wrench	9114D	14mm Combination Ratcheting Wrench
9109	9mm Combination Ratcheting Wrench	9115D	15mm Combination Ratcheting Wrench
9110D	10mm Combination Ratcheting Wrench	9116D	16mm Combination Ratcheting Wrench
9111	11mm Combination Ratcheting Wrench	9117D	17mm Combination Ratcheting Wrench
9112	12mm Combination Ratcheting Wrench	9118D	18mm Combination Ratcheting Wrench
9113D	13mm Combination Ratcheting Wrench	9119	19mm Combination Ratcheting Wrench

GEARWRENCH® 10 Pc. 12 Point SAE/Metric Combination Ratcheting Wrench Set

- Ratcheting Box End Needs As Little As 5° to Move Fasteners vs. 30° for Standard Wrenches
- Bright, Full Polish Chrome Finish
- The Original Patented Ratcheting Wrench
- Surface Drive® on Box End Provides Off-Corner Loading for Better Grip and Reduced Fastener Rounding



Cat. No.	UPC No.	Packaging	Product Weight
9418	082171094187	Carded	2.04 lb

Cat. No.	Description	Cat. No.	Description
9108D	8mm Combination Ratcheting Wrench	9010D	5/16" Combination Ratcheting Wrench
9110D	10mm Combination Ratcheting Wrench	9012D	3/8" Combination Ratcheting Wrench
9112	12mm Combination Ratcheting Wrench	9014	7/16" Combination Ratcheting Wrench
9113D	13mm Combination Ratcheting Wrench	9016D	1/2" Combination Ratcheting Wrench
9114D	14mm Combination Ratcheting Wrench	9018D	9/16" Combination Ratcheting Wrench

GEARWRENCH® 8 Pc. 12 Point SAE Combination Ratcheting Wrench Set

- Ratcheting Box End Needs As Little As 5° to Move Fasteners vs. 30° for Standard Wrenches
- Bright, Full Polish Chrome Finish
- The Original Patented Ratcheting Wrench
- Surface Drive® on Box End Provides Off-Corner Loading for Better Grip and Reduced Fastener Rounding



Cat. No.	UPC No.	Packaging	Product Weight
9308D	082171093081	Blow Mold Tray	2.70 lb

Cat. No.	Description	Cat. No.	Description
9010D	5/16" Combination Ratcheting Wrench	9018D	9/16" Combination Ratcheting Wrench
9012D	3/8" Combination Ratcheting Wrench	9020	5/8" Combination Ratcheting Wrench
9014	7/16" Combination Ratcheting Wrench	9022	11/16" Combination Ratcheting Wrench
9016D	1/2" Combination Ratcheting Wrench	9024	3/4" Combination Ratcheting Wrench

GEARWRENCH® 7 Pc. 12 Point SAE Combination Ratcheting Wrench Set

- Ratcheting Box End Needs As Little As 5° to Move Fasteners vs. 30° for Standard Wrenches
- Bright, Full Polish Chrome Finish
- The Original Patented Ratcheting Wrench
- Surface Drive® on Box End Provides Off-Corner Loading for Better Grip and Reduced Fastener Rounding



Cat. No.	UPC No.	Packaging	Product Weight
9317	082171093173	Carded	2.02 lb

Cat. No.	Description	Cat. No.	Description
9010D	5/16" Combination Ratcheting Wrench	9018D	9/16" Combination Ratcheting Wrench
9012D	3/8" Combination Ratcheting Wrench	9020	5/8" Combination Ratcheting Wrench
9014	7/16" Combination Ratcheting Wrench	9024	3/4" Combination Ratcheting Wrench
9016D	1/2" Combination Ratcheting Wrench		

GEARWRENCH® 7 Pc. 12 Point Metric Combination Ratcheting Wrench Set

- Ratcheting Box End Needs As Little As 5° to Move Fasteners vs. 30° for Standard Wrenches
- Bright, Full Polish Chrome Finish
- The Original Patented Ratcheting Wrench
- Surface Drive® on Box End Provides Off-Corner Loading for Better Grip and Reduced Fastener Rounding



Cat. No.	UPC No.	Packaging	Product Weight
9417	082171094170	Carded	2.15 lb

Cat. No.	Description	Cat. No.	Description
9108D	8mm Combination Ratcheting Wrench	9114D	14mm Combination Ratcheting Wrench
9110D	10mm Combination Ratcheting Wrench	9115D	15mm Combination Ratcheting Wrench
9112	12mm Combination Ratcheting Wrench	9118D	18mm Combination Ratcheting Wrench
9113D	13mm Combination Ratcheting Wrench		

GEARWRENCH® 5 Pc. 12 Point SAE Combination Ratcheting Wrench Set

- Ratcheting Box End Needs As Little As 5° to Move Fasteners vs. 30° for Standard Wrenches
- Bright, Full Polish Chrome Finish
- The Original Patented Ratcheting Wrench
- Surface Drive® on Box End Provides Off-Corner Loading for Better Grip and Reduced Fastener Rounding



Cat. No.	UPC No.	Packaging	Product Weight
93005	099575930058	Carded	4.16 lb

Cat. No.	Description	Cat. No.	Description
9012D	3/8" Combination Ratcheting Wrench	9018D	9/16" Combination Ratcheting Wrench
9014	7/16" Combination Ratcheting Wrench	9020	5/8" Combination Ratcheting Wrench
9016D	1/2" Combination Ratcheting Wrench		

GEARWRENCH® 4 Pc. 12 Point Metric Large Combination Ratcheting Wrench Set

- Ratcheting Box End Needs As Little As 5° to Move Fasteners vs. 30° for Standard Wrenches
- Bright, Full Polish Chrome Finish
- The Original Patented Ratcheting Wrench
- Surface Drive® on Box End Provides Off-Corner Loading for Better Grip and Reduced Fastener Rounding



Cat. No.	UPC No.	Packaging	Product Weight
9413	082171094132	Blow Mold Tray	4.67 lb

Cat. No.	Description	Cat. No.	Description
9121	21mm Combination Ratcheting Wrench	9124	24mm Combination Ratcheting Wrench
9122	22mm Combination Ratcheting Wrench	9125D	25mm Combination Ratcheting Wrench

GEARWRENCH® 4 Pc. 12 Point SAE Large Combination Ratcheting Wrench Set

- Ratcheting Box End Needs As Little As 5° to Move Fasteners vs. 30° for Standard Wrenches
- Bright, Full Polish Chrome Finish
- The Original Patented Ratcheting Wrench
- Surface Drive® on Box End Provides Off-Corner Loading for Better Grip and Reduced Fastener Rounding



Cat. No.	UPC No.	Packaging	Product Weight
9309D	082171093098	Blow Mold Tray	4.79 lb

Cat. No.	Description	Cat. No.	Description
9026D	13/16" Combination Ratcheting Wrench	9030	15/16" Combination Ratcheting Wrench
9028D	7/8" Combination Ratcheting Wrench	9032	1" Combination Ratcheting Wrench

GEARWRENCH® 5 Pc. 12 Point Metric Combination Ratcheting Wrench Set

- Ratcheting Box End Needs As Little As 5° to Move Fasteners vs. 30° for Standard Wrenches
- Bright, Full Polish Chrome Finish
- The Original Patented Ratcheting Wrench
- Surface Drive® on Box End Provides Off-Corner Loading for Better Grip and Reduced Fastener Rounding

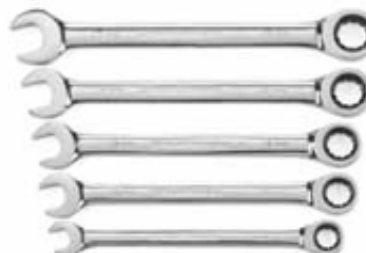

Cat. No.	UPC No.	Packaging	Product Weight
93004D	099575930041	Carded	4.40 lb

Cat. No.	Description	Cat. No.	Description
9110D	10mm Combination Ratcheting Wrench	9114D	14mm Combination Ratcheting Wrench
9112	12mm Combination Ratcheting Wrench	9115D	15mm Combination Ratcheting Wrench
9113D	13mm Combination Ratcheting Wrench		

GEARWRENCH® 4 Pc. 12 Point SAE Combination Ratcheting Wrench Set

- Ratcheting Box End Needs As Little As 5° to Move Fasteners vs. 30° for Standard Wrenches
- Bright, Full Polish Chrome Finish
- The Original Patented Ratcheting Wrench
- Surface Drive® on Box End Provides Off-Corner Loading for Better Grip and Reduced Fastener Rounding



Cat. No.	UPC No.	Packaging	Product Weight
9304	082171093043	Carded	0.88 lb

Cat. No.	Description	Cat. No.	Description
9012D	3/8" Combination Ratcheting Wrench	9016D	1/2" Combination Ratcheting Wrench
9014	7/16" Combination Ratcheting Wrench	9018D	9/16" Combination Ratcheting Wrench

GEARWRENCH® 4 Pc. 12 Point Metric Combination Ratcheting Wrench Set

- Ratcheting Box End Needs As Little As 5° to Move Fasteners vs. 30° for Standard Wrenches
- Bright, Full Polish Chrome Finish
- The Original Patented Ratcheting Wrench
- Surface Drive® on Box End Provides Off-Corner Loading for Better Grip and Reduced Fastener Rounding



Cat. No.	UPC No.	Packaging	Product Weight
9404	082171094040	Carded	0.45 lb

Cat. No.	Description	Cat. No.	Description
9110D	10mm Combination Ratcheting Wrench	9113D	13mm Combination Ratcheting Wrench
9112	12mm Combination Ratcheting Wrench	9114D	14mm Combination Ratcheting Wrench

GEARWRENCH® 12 Point SAE Combination Ratcheting Wrenches

- Ratcheting Box End Needs As Little As 5° to Move Fasteners vs. 30° for Standard Wrenches
- Bright, Full Polish Chrome Finish
- The Original Patented Ratcheting Wrench
- Surface Drive® on Box End Provides Off-Corner Loading for Better Grip and Reduced Fastener Rounding



Cat. No.	UPC No.	Packaging	Fastener Size	End A Width	End A Thickness	End B Width	End B Thickness	Overall Length	Product Weight
9008	082171090080	Carded	1/4 in	0.567 in	0.181 in	0.610 in	0.256 in	4.921 in	0.10 lb
9010D	082171090103	Carded	5/16 in	0.768 in	0.197 in	0.665 in	0.272 in	5.508 in	0.12 lb
9011D	082171090110	Carded	11/32 in	0.768 in	0.213 in	0.701 in	0.272 in	5.882 in	0.12 lb
9012D	082171090127	Carded	3/8 in	0.862 in	0.224 in	0.780 in	0.303 in	6.256 in	0.14 lb
9014	082171090141	Carded	7/16 in	0.953 in	0.252 in	0.854 in	0.323 in	6.508 in	0.17 lb
9016D	082171090165	Carded	1/2 in	1.146 in	0.319 in	0.984 in	0.339 in	7.008 in	0.22 lb
9018D	082171090189	Carded	9/16 in	1.228 in	0.327 in	1.035 in	0.370 in	7.504 in	0.23 lb
9020	082171090202	Carded	5/8 in	1.358 in	0.346 in	1.201 in	0.406 in	8.201 in	0.33 lb
9022	082171090226	Carded	11/16 in	1.492 in	0.362 in	1.272 in	0.421 in	8.878 in	0.38 lb
9024	082171090240	Carded	3/4 in	1.626 in	0.374 in	1.339 in	0.441 in	9.764 in	0.47 lb
9026D	082171090264	Carded	13/16 in	1.811 in	0.390 in	1.535 in	0.512 in	11.476 in	0.86 lb
9028D	082171090288	Carded	7/8 in	1.811 in	0.390 in	1.535 in	0.512 in	11.476 in	0.80 lb
9030	082171090301	Carded	15/16 in	2.055 in	0.429 in	1.791 in	0.571 in	13.114 in	1.17 lb
9032	082171090325	Carded	1 in	2.055 in	0.429 in	1.791 in	0.571 in	13.114 in	1.15 lb
9034	082171090349	Carded	1-1/16 in	2.220 in	0.571 in	1.929 in	0.610 in	14.142 in	1.32 lb
9036	082171090363	Carded	1-1/8 in	2.469 in	0.492 in	2.154 in	0.669 in	15.846 in	1.97 lb
9038D	082171090387	Carded	1-1/4 in	2.634 in	0.508 in	2.283 in	0.689 in	16.764 in	2.18 lb
9060D	082171090608	Carded	1-5/16 in	2.744 in	0.539 in	2.362 in	0.689 in	18.110 in	2.64 lb
9062D	082171090622	Carded	1-3/8 in	2.744 in	0.539 in	2.362 in	0.689 in	18.110 in	2.64 lb
9040	082171090400	Carded	1-7/16 in	3.114 in	0.646 in	2.520 in	0.807 in	19.685 in	3.86 lb
9042	082171090424	Carded	1-1/2 in	3.114 in	0.646 in	2.520 in	0.807 in	19.685 in	3.82 lb
9044	082171090448	Carded	1-9/16 in	3.409 in	0.709 in	2.677 in	0.866 in	22.638 in	5.18 lb
9046D	082171090462	Carded	1-5/8 in	3.409 in	0.709 in	2.677 in	0.866 in	22.638 in	5.14 lb
9048	082171090486	Carded	1-11/16 in	3.626 in	0.791 in	2.835 in	0.925 in	24.213 in	5.69 lb
9050D	082171090509	Boxed	1-3/4 in	3.626 in	0.791 in	2.835 in	0.925 in	24.213 in	5.64 lb
9052D	082171090523	Boxed	1-13/16 in	3.850 in	0.835 in	2.992 in	0.984 in	25.394 in	7.65 lb
9054D	082171090547	Boxed	1-7/8 in	3.850 in	0.835 in	2.992 in	0.984 in	25.394 in	7.59 lb
9056D	082171090561	Boxed	2 in	4.134 in	0.835 in	3.150 in	1.043 in	25.787 in	8.34 lb

GEARWRENCH® 12 Point Metric Combination Ratcheting Wrenches

- Ratcheting Box End Needs As Little As 5° to Move Fasteners vs. 30° for Standard Wrenches
- Bright, Full Polish Chrome Finish
- The Original Patented Ratcheting Wrench
- Surface Drive® on Box End Provides Off-Corner Loading for Better Grip and Reduced Fastener Rounding



Cat. No.	UPC No.	Packaging	Fastener Size	End A Width	End A Thickness	End B Width	End B Thickness	Overall Length	Product Weight
9106	082171091063	Carded	6 mm	0.567 in	0.181 in	0.610 in	0.256 in	4.921 in	0.09 lb
9107	082171091070	Carded	7 mm	0.642 in	0.189 in	0.622 in	0.256 in	5.236 in	0.07 lb
9108D	082171091087	Carded	8 mm	0.768 in	0.197 in	0.665 in	0.272 in	5.508 in	0.10 lb
9109	082171091094	Carded	9 mm	0.768 in	0.213 in	0.701 in	0.272 in	5.882 in	0.11 lb
9110D	082171091100	Carded	10 mm	0.862 in	0.224 in	0.780 in	0.303 in	6.256 in	0.15 lb
9111	082171091117	Carded	11 mm	0.953 in	0.252 in	0.854 in	0.323 in	6.508 in	0.15 lb
9112	082171091124	Carded	12 mm	1.047 in	0.291 in	0.906 in	0.339 in	6.756 in	0.20 lb
9113D	082171091131	Carded	13 mm	1.146 in	0.319 in	0.984 in	0.339 in	7.008 in	0.23 lb
9114D	082171091148	Carded	14 mm	1.228 in	0.327 in	1.035 in	0.370 in	7.504 in	0.27 lb
9115D	082171091155	Carded	15 mm	1.327 in	0.327 in	1.130 in	0.390 in	7.854 in	0.25 lb
9116D	082171091162	Carded	16 mm	1.358 in	0.346 in	1.201 in	0.406 in	8.201 in	0.33 lb
9117D	082171091179	Carded	17 mm	1.492 in	0.362 in	1.272 in	0.421 in	8.878 in	0.38 lb
9118D	082171091186	Carded	18 mm	1.583 in	0.370 in	1.307 in	0.441 in	9.311 in	0.46 lb
9119	082171091193	Carded	19 mm	1.626 in	0.374 in	1.339 in	0.441 in	9.764 in	0.47 lb
9120	082171091209	Carded	20 mm	1.811 in	0.390 in	1.535 in	0.512 in	11.476 in	0.78 lb
9121	082171091216	Carded	21 mm	1.811 in	0.390 in	1.535 in	0.512 in	11.476 in	0.81 lb
9122	082171091223	Carded	22 mm	1.811 in	0.390 in	1.535 in	0.512 in	11.476 in	0.80 lb
9124	082171091247	Carded	24 mm	2.055 in	0.429 in	1.791 in	0.571 in	13.114 in	1.15 lb
9125D	082171091254	Carded	25 mm	2.055 in	0.429 in	1.791 in	0.571 in	13.114 in	1.16 lb
9127D	082171091278	Carded	27 mm	2.220 in	0.571 in	1.929 in	0.610 in	14.142 in	1.32 lb
9130D	082171091308	Carded	30 mm	2.469 in	0.492 in	2.154 in	0.669 in	15.846 in	1.75 lb
9132	082171091322	Carded	32 mm	2.634 in	0.508 in	2.283 in	0.689 in	16.764 in	2.21 lb
9134D	082171091346	Carded	34 mm	2.744 in	0.539 in	2.362 in	0.689 in	18.110 in	2.61 lb
9136	082171091360	Boxed	36 mm	3.114 in	0.646 in	2.520 in	0.807 in	19.685 in	4.45 lb
9141D	082171091414	Boxed	41 mm	3.409 in	0.709 in	2.677 in	0.866 in	22.638 in	5.73 lb
9146D	082171091469	Boxed	45 mm	3.850 in	0.835 in	2.992 in	0.984 in	25.394 in	7.92 lb
9150	082171091506	Boxed	50 mm	4.134 in	0.835 in	3.150 in	1.043 in	25.787 in	8.78 lb

GEARWRENCH® 10 Pc. 12 Point Metric Stubby Combination Ratcheting Wrench Set

- Ratcheting Box End Needs As Little As 5° to Move Fasteners vs. 30° for Standard Wrenches
- Bright, Full Polish Chrome Finish
- The Original Patented Ratcheting Wrench
- Surface Drive® on Box End Provides Off-Corner Loading for Better Grip and Reduced Fastener Rounding
- Stubby Length for Tight Access Areas



Cat. No.	UPC No.	Packaging	Product Weight
9520D	082171095207	Blow Mold Tray	2.30 lb

Cat. No.	Description	Cat. No.	Description
9510DD	10mm Stubby Combination Ratcheting Wrench	9515D	15mm Stubby Combination Ratcheting Wrench
9511D	11mm Stubby Combination Ratcheting Wrench	9516D	16mm Stubby Combination Ratcheting Wrench
9512D	12mm Stubby Combination Ratcheting Wrench	9517D	17mm Stubby Combination Ratcheting Wrench
9513D	13mm Stubby Combination Ratcheting Wrench	9518D	18mm Stubby Combination Ratcheting Wrench
9514D	14mm Stubby Combination Ratcheting Wrench	9519D	19mm Stubby Combination Ratcheting Wrench

GEARWRENCH® 7 Pc. 12 Point SAE Stubby Combination Ratcheting Wrench Set

- Ratcheting Box End Needs As Little As 5° to Move Fasteners vs. 30° for Standard Wrenches
- Bright, Full Polish Chrome Finish
- The Original Patented Ratcheting Wrench
- Surface Drive® on Box End Provides Off-Corner Loading for Better Grip and Reduced Fastener Rounding
- Stubby Length for Tight Access Areas



Cat. No.	UPC No.	Packaging	Product Weight
9507D	082171095078	Blow Mold Tray	1.82 lb

Cat. No.	Description	Cat. No.	Description
9500DD	3/8" Stubby Combination Ratcheting Wrench	9504D	5/8" Stubby Combination Ratcheting Wrench
9501DD	7/16" Stubby Combination Ratcheting Wrench	9505D	11/16" Stubby Combination Ratcheting Wrench
9502D	1/2" Stubby Combination Ratcheting Wrench	9506D	3/4" Stubby Combination Ratcheting Wrench
9503D	9/16" Stubby Combination Ratcheting Wrench		

GEARWRENCH® 12 Point SAE Stubby Combination Ratcheting Wrenches

- Stubby Length for Tight Access Areas
- Ratcheting Box End Needs As Little As 5° to Move Fasteners vs. 30° for Standard Wrenches
- Bright, Full Polish Chrome Finish
- Surface Drive® on Box End Provides Off-Corner Loading for Better Grip and Reduced Fastener Rounding



Cat. No.	UPC No.	Packaging	Fastener Size	End A Width	End A Thickness	End B Width	End B Thickness	Overall Length	Product Weight
9500DD	082171095009	Carded	3/8 in	0.862 in	0.224 in	0.780 in	0.303 in	3.701 in	0.08 lb
9501DD	082171095016	Carded	7/16 in	0.953 in	0.252 in	0.854 in	0.323 in	4.016 in	0.15 lb
9502D	082171095023	Carded	1/2 in	1.146 in	0.319 in	0.984 in	0.339 in	4.213 in	0.18 lb
9503D	082171095030	Carded	9/16 in	1.228 in	0.327 in	1.035 in	0.370 in	4.488 in	0.20 lb
9504D	082171095047	Carded	5/8 in	1.358 in	0.346 in	1.201 in	0.406 in	4.803 in	0.22 lb
9505D	082171095054	Carded	11/16 in	1.492 in	0.362 in	1.272 in	0.421 in	4.961 in	0.24 lb
9506D	082171095061	Carded	3/4 in	1.626 in	0.374 in	1.339 in	0.441 in	5.433 in	0.31 lb

GEARWRENCH® 12 Point Metric Stubby Combination Ratcheting Wrenches

- Stubby Length for Tight Access Areas
- Ratcheting Box End Needs As Little As 5° to Move Fasteners vs. 30° for Standard Wrenches
- Bright, Full Polish Chrome Finish
- Surface Drive® on Box End Provides Off-Corner Loading for Better Grip and Reduced Fastener Rounding



Cat. No.	UPC No.	Packaging	Fastener Size	End A Width	End A Thickness	End B Width	End B Thickness	Overall Length	Product Weight
9510DD	082171095108	Carded	10 mm	0.862 in	0.224 in	0.780 in	0.303 in	3.701 in	0.08 lb
9511D	082171095115	Carded	11 mm	0.953 in	0.252 in	0.854 in	0.323 in	4.016 in	0.10 lb
9512D	082171095122	Carded	12 mm	1.047 in	0.291 in	0.906 in	0.339 in	4.134 in	0.12 lb
9513D	082171095139	Carded	13 mm	1.146 in	0.319 in	0.984 in	0.339 in	4.213 in	0.13 lb
9514D	082171095146	Carded	14 mm	1.228 in	0.327 in	1.035 in	0.370 in	4.488 in	0.16 lb
9515D	082171095153	Carded	15 mm	1.327 in	0.327 in	1.130 in	0.390 in	4.646 in	0.2 lb
9516D	082171095160	Carded	16 mm	1.358 in	0.346 in	1.201 in	0.406 in	4.803 in	0.21 lb
9517D	082171095177	Carded	17 mm	1.492 in	0.362 in	1.272 in	0.421 in	4.961 in	0.25 lb
9518D	082171095184	Carded	18 mm	1.583 in	0.370 in	1.307 in	0.441 in	5.118 in	0.29 lb
9519D	082171095191	Carded	19 mm	1.626 in	0.374 in	1.339 in	0.441 in	5.433 in	0.32 lb

GEARWRENCH® 16 Pc. 12 Point Metric Reversible Combination Ratcheting Wrench Set

- 15° Offset Offers Increased Clearance
- Flush Mounted Reversing Lever Improves Access
- 72 Teeth Ratcheting Box End Needs As Little As 5° to Move Fasteners Versus 30° for Standard Box End Wrenches
- Surface Drive® on Box End Provides Off-Corner Loading for Better Grip and Reduced Fastener Rounding



Cat. No.	UPC No.	Packaging	Product Weight
9602N	082171096020	Carded	7.54 lb

Cat. No.	Description	Cat. No.	Description
9608N	8mm Reversible Combination Ratcheting Wrench	9616N	16mm Reversible Combination Ratcheting Wrench
9609N	9mm Reversible Combination Ratcheting Wrench	9617N	17mm Reversible Combination Ratcheting Wrench
9610N	10mm Reversible Combination Ratcheting Wrench	9618N	18mm Reversible Combination Ratcheting Wrench
9611N	11mm Reversible Combination Ratcheting Wrench	9619N	19mm Reversible Combination Ratcheting Wrench
9612N	12mm Reversible Combination Ratcheting Wrench	9621N	21mm Reversible Combination Ratcheting Wrench
9613N	13mm Reversible Combination Ratcheting Wrench	9622N	22mm Reversible Combination Ratcheting Wrench
9614N	14mm Reversible Combination Ratcheting Wrench	9624N	24mm Reversible Combination Ratcheting Wrench
9615N	15mm Reversible Combination Ratcheting Wrench	9625N	25mm Reversible Combination Ratcheting Wrench

GEARWRENCH® 16 Pc. 12 Point Metric Reversible Combination Ratcheting Wrench Set with Wrench Roll

- 15° Offset Offers Increased Clearance
- Flush Mounted Reversing Lever Improves Access
- 72 Teeth Ratcheting Box End Needs As Little As 5° to Move Fasteners Versus 30° for Standard Box End Wrenches
- Surface Drive® on Box End Provides Off-Corner Loading for Better Grip and Reduced Fastener Rounding



Cat. No.	UPC No.	Packaging	Product Weight
9602RN	082171960215	Pouch	7.85 lb

Cat. No.	Description	Cat. No.	Description
9608N	8mm Reversible Combination Ratcheting Wrench	9616N	16mm Reversible Combination Ratcheting Wrench
9609N	9mm Reversible Combination Ratcheting Wrench	9617N	17mm Reversible Combination Ratcheting Wrench
9610N	10mm Reversible Combination Ratcheting Wrench	9618N	18mm Reversible Combination Ratcheting Wrench
9611N	11mm Reversible Combination Ratcheting Wrench	9619N	19mm Reversible Combination Ratcheting Wrench
9612N	12mm Reversible Combination Ratcheting Wrench	9621N	21mm Reversible Combination Ratcheting Wrench
9613N	13mm Reversible Combination Ratcheting Wrench	9622N	22mm Reversible Combination Ratcheting Wrench
9614N	14mm Reversible Combination Ratcheting Wrench	9624N	24mm Reversible Combination Ratcheting Wrench
9615N	15mm Reversible Combination Ratcheting Wrench	9625N	25mm Reversible Combination Ratcheting Wrench

GEARWRENCH® 13 Pc. 12 Point SAE Reversible Combination Ratcheting Wrench Set

- 15° Offset Offers Increased Clearance
- Flush Mounted Reversing Lever Improves Access
- 72 Teeth Ratcheting Box End Needs As Little As 5° to Move Fasteners Versus 30° for Standard Box End Wrenches
- Surface Drive® on Box End Provides Off-Corner Loading for Better Grip and Reduced Fastener Rounding



Cat. No.	UPC No.	Packaging	Product Weight
9509N	082171095092	Carded	6.65 lb

Cat. No.	Description	Cat. No.	Description
9525ND	5/16" Reversible Combination Ratcheting Wrench	9531ND	11/16" Reversible Combination Ratcheting Wrench
9521ND	11/32" Reversible Combination Ratcheting Wrench	9532N	3/4" Reversible Combination Ratcheting Wrench
9526ND	3/8" Reversible Combination Ratcheting Wrench	9534N	13/16" Reversible Combination Ratcheting Wrench
9527N	7/16" Reversible Combination Ratcheting Wrench	9538N	7/8" Reversible Combination Ratcheting Wrench
9528N	1/2" Reversible Combination Ratcheting Wrench	9539N	15/16" Reversible Combination Ratcheting Wrench
9529N	9/16" Reversible Combination Ratcheting Wrench	9540N	1" Reversible Combination Ratcheting Wrench
9530ND	5/8" Reversible Combination Ratcheting Wrench		

GEARWRENCH® 13 Pc. 12 Point SAE Reversible Combination Ratcheting Wrench Set with Wrench Roll

- 15° Offset Offers Increased Clearance
- Flush Mounted Reversing Lever Improves Access
- 72 Teeth Ratcheting Box End Needs As Little As 5° to Move Fasteners Versus 30° for Standard Box End Wrenches
- Surface Drive® on Box End Provides Off-Corner Loading for Better Grip and Reduced Fastener Rounding



Cat. No.	UPC No.	Packaging	Product Weight
9509RN	082171950919	Pouch	6.89 lb

Cat. No.	Description	Cat. No.	Description
9525ND	5/16" Reversible Combination Ratcheting Wrench	9531ND	11/16" Reversible Combination Ratcheting Wrench
9521ND	11/32" Reversible Combination Ratcheting Wrench	9532N	3/4" Reversible Combination Ratcheting Wrench
9526ND	3/8" Reversible Combination Ratcheting Wrench	9534N	13/16" Reversible Combination Ratcheting Wrench
9527N	7/16" Reversible Combination Ratcheting Wrench	9538N	7/8" Reversible Combination Ratcheting Wrench
9528N	1/2" Reversible Combination Ratcheting Wrench	9539N	15/16" Reversible Combination Ratcheting Wrench
9529N	9/16" Reversible Combination Ratcheting Wrench	9540N	1" Reversible Combination Ratcheting Wrench
9530ND	5/8" Reversible Combination Ratcheting Wrench		

GEARWRENCH® 12 Pc. 12 Point Metric Reversible Combination Ratcheting Wrench Set

- 15° Offset Offers Increased Clearance
- Flush Mounted Reversing Lever Improves Access
- 72 Teeth Ratcheting Box End Needs As Little As 5° to Move Fasteners Versus 30° for Standard Box End Wrenches
- Surface Drive® on Box End Provides Off-Corner Loading for Better Grip and Reduced Fastener Rounding



Cat. No.	UPC No.	Packaging	Product Weight
9620N	082171096204	Carded	3.75 lb

Cat. No.	Description	Cat. No.	Description
9608N	8mm Reversible Combination Ratcheting Wrench	9614N	14mm Reversible Combination Ratcheting Wrench
9609N	9mm Reversible Combination Ratcheting Wrench	9615N	15mm Reversible Combination Ratcheting Wrench
9610N	10mm Reversible Combination Ratcheting Wrench	9616N	16mm Reversible Combination Ratcheting Wrench
9611N	11mm Reversible Combination Ratcheting Wrench	9617N	17mm Reversible Combination Ratcheting Wrench
9612N	12mm Reversible Combination Ratcheting Wrench	9618N	18mm Reversible Combination Ratcheting Wrench
9613N	13mm Reversible Combination Ratcheting Wrench	9619N	19mm Reversible Combination Ratcheting Wrench

GEARWRENCH® 10 Pc. 12 Point Metric Reversible Combination Ratcheting Wrench Set with Wrench Roll

- 15° Offset Offers Increased Clearance
- Flush Mounted Reversing Lever Improves Access
- 72 Teeth Ratcheting Box End Needs As Little As 5° to Move Fasteners Versus 30° for Standard Box End Wrenches
- Surface Drive® on Box End Provides Off-Corner Loading for Better Grip and Reduced Fastener Rounding



Cat. No.	UPC No.	Packaging	Product Weight
9601RN	082171960116	Pouch	3.60 lb

Cat. No.	Description	Cat. No.	Description
9610N	10mm Reversible Combination Ratcheting Wrench	9615N	15mm Reversible Combination Ratcheting Wrench
9611N	11mm Reversible Combination Ratcheting Wrench	9616N	16mm Reversible Combination Ratcheting Wrench
9612N	12mm Reversible Combination Ratcheting Wrench	9617N	17mm Reversible Combination Ratcheting Wrench
9613N	13mm Reversible Combination Ratcheting Wrench	9618N	18mm Reversible Combination Ratcheting Wrench
9614N	14mm Reversible Combination Ratcheting Wrench	9619N	19mm Reversible Combination Ratcheting Wrench

GEARWRENCH® 8 Pc. 12 Point SAE Reversible Combination Ratcheting Wrench Set

- 15° Offset Offers Increased Clearance
- Flush Mounted Reversing Lever Improves Access
- 72 Teeth Ratcheting Box End Needs As Little As 5° to Move Fasteners Versus 30° for Standard Box End Wrenches
- Surface Drive® on Box End Provides Off-Corner Loading for Better Grip and Reduced Fastener Rounding



Cat. No.	UPC No.	Packaging	Product Weight
9533N	082171095337	Carded	2.71 lb

Cat. No.	Description	Cat. No.	Description
9525ND	5/16" Reversible Combination Ratcheting Wrench	9529N	9/16" Reversible Combination Ratcheting Wrench
9526ND	3/8" Reversible Combination Ratcheting Wrench	9530ND	5/8" Reversible Combination Ratcheting Wrench
9527N	7/16" Reversible Combination Ratcheting Wrench	9531ND	11/16" Reversible Combination Ratcheting Wrench
9528N	1/2" Reversible Combination Ratcheting Wrench	9532N	3/4" Reversible Combination Ratcheting Wrench

GEARWRENCH® 7 Pc. 12 Point SAE Reversible Combination Ratcheting Wrench Set with Wrench Roll

- 15° Offset Offers Increased Clearance
- Flush Mounted Reversing Lever Improves Access
- 72 Teeth Ratcheting Box End Needs As Little As 5° to Move Fasteners Versus 30° for Standard Box End Wrenches
- Surface Drive® on Box End Provides Off-Corner Loading for Better Grip and Reduced Fastener Rounding



Cat. No.	UPC No.	Packaging	Product Weight
9567RN	082171956706	Pouch	2.30 lb

Cat. No.	Description	Cat. No.	Description
9526ND	3/8" Reversible Combination Ratcheting Wrench	9530ND	5/8" Reversible Combination Ratcheting Wrench
9527N	7/16" Reversible Combination Ratcheting Wrench	9531ND	11/16" Reversible Combination Ratcheting Wrench
9528N	1/2" Reversible Combination Ratcheting Wrench	9532N	3/4" Reversible Combination Ratcheting Wrench
9529N	9/16" Reversible Combination Ratcheting Wrench		

GEARWRENCH® 8 Pc. 12 Point Metric Reversible Combination Ratcheting Wrench Set

- 15° Offset Offers Increased Clearance
- Flush Mounted Reversing Lever Improves Access
- 72 Teeth Ratcheting Box End Needs As Little As 5° to Move Fasteners Versus 30° for Standard Box End Wrenches
- Surface Drive® on Box End Provides Off-Corner Loading for Better Grip and Reduced Fastener Rounding



Cat. No.	UPC No.	Packaging	Product Weight
9543	099575095436	Carded	2.71 lb

Cat. No.	Description	Cat. No.	Description
9608N	8mm Reversible Combination Ratcheting Wrench	9614N	14mm Reversible Combination Ratcheting Wrench
9610N	10mm Reversible Combination Ratcheting Wrench	9615N	15mm Reversible Combination Ratcheting Wrench
9612N	12mm Reversible Combination Ratcheting Wrench	9617N	17mm Reversible Combination Ratcheting Wrench
9613N	13mm Reversible Combination Ratcheting Wrench	9619N	19mm Reversible Combination Ratcheting Wrench

GEARWRENCH® 4 Pc. 12 Point SAE Reversible Combination Ratcheting Wrench Set

- 15° Offset Offers Increased Clearance
- Flush Mounted Reversing Lever Improves Access
- 72 Teeth Ratcheting Box End Needs As Little As 5° to Move Fasteners Versus 30° for Standard Box End Wrenches
- Surface Drive® on Box End Provides Off-Corner Loading for Better Grip and Reduced Fastener Rounding



Cat. No.	UPC No.	Packaging	Product Weight
9545N	082171954504	Carded	4.26 lb

Cat. No.	Description	Cat. No.	Description
9534N	13/16" Reversible Combination Ratcheting Wrench	9539N	15/16" Reversible Combination Ratcheting Wrench
9538N	7/8" Reversible Combination Ratcheting Wrench	9540N	1" Reversible Combination Ratcheting Wrench

GEARWRENCH® 4 Pc. 12 Point Metric Reversible Combination Ratcheting Wrench Set

- 15° Offset Offers Increased Clearance
- Flush Mounted Reversing Lever Improves Access
- 72 Teeth Ratcheting Box End Needs As Little As 5° to Move Fasteners Versus 30° for Standard Box End Wrenches
- Surface Drive® on Box End Provides Off-Corner Loading for Better Grip and Reduced Fastener Rounding



Cat. No.	UPC No.	Packaging	Product Weight
9601N	082171960109	Carded	4.27 lb

Cat. No.	Description	Cat. No.	Description
9621N	21mm Reversible Combination Ratcheting Wrench	9624N	24mm Reversible Combination Ratcheting Wrench
9622N	22mm Reversible Combination Ratcheting Wrench	9625N	25mm Reversible Combination Ratcheting Wrench

GEARWRENCH® 12 Point SAE Reversible Combination Ratcheting Wrenches

- 15° Offset Offers Increased Clearance
- Flush Mounted Reversing Lever Improves Access
- 72 Teeth Ratcheting Box End Needs As Little As 5° to Move Fasteners Versus 30° for Standard Box End Wrenches
- Surface Drive® on Box End Provides Off-Corner Loading for Better Grip and Reduced Fastener Rounding



Cat. No.	UPC No.	Packaging	Fastener Size	End A Width	End A Thickness	End B Width	End B Thickness	Overall Length	Product Weight
9525ND	082171095252	Carded	5/16 in	0.768 in	0.197 in	0.665 in	0.272 in	5.433 in	0.11 lb
9521ND	082171095214	Carded	11/32 in	0.768 in	0.213 in	0.701 in	0.272 in	5.795 in	0.12 lb
9526ND	082171095269	Carded	3/8 in	0.862 in	0.224 in	0.780 in	0.303 in	6.169 in	0.14 lb
9527N	082171095276	Carded	7/16 in	0.953 in	0.252 in	0.854 in	0.323 in	6.413 in	0.16 lb
9528N	082171095283	Carded	1/2 in	1.146 in	0.319 in	0.984 in	0.339 in	6.902 in	0.22 lb
9529N	082171095290	Carded	9/16 in	1.228 in	0.327 in	1.035 in	0.370 in	7.398 in	0.27 lb
9530ND	082171095306	Carded	5/8 in	1.358 in	0.346 in	1.201 in	0.406 in	8.087 in	0.34 lb
9531ND	082171095313	Carded	11/16 in	1.492 in	0.362 in	1.272 in	0.421 in	8.740 in	0.40 lb
9532N	082171095320	Carded	3/4 in	1.626 in	0.374 in	1.339 in	0.441 in	9.594 in	0.53 lb
9534N	082171095344	Carded	13/16 in	1.811 in	0.390 in	1.535 in	0.512 in	11.476 in	0.91 lb
9538N	082171095382	Carded	7/8 in	1.811 in	0.390 in	1.535 in	0.512 in	11.476 in	1.17 lb
9539N	082171095399	Carded	15/16 in	2.055 in	0.429 in	1.791 in	0.571 in	14.000 in	1.27 lb
9540N	082171095405	Carded	1 in	2.055 in	0.429 in	1.791 in	0.571 in	14.000 in	1.32 lb

GEARWRENCH® 12 Point Metric Reversible Combination Ratcheting Wrenches

- 15° Offset Offers Increased Clearance
- Flush Mounted Reversing Lever Improves Access
- 72 Teeth Ratcheting Box End Needs As Little As 5° to Move Fasteners Versus 30° for Standard Box End Wrenches
- Surface Drive® on Box End Provides Off-Corner Loading for Better Grip and Reduced Fastener Rounding



Cat. No.	UPC No.	Packaging	Fastener Size	End A Width	End A Thickness	End B Width	End B Thickness	Overall Length	Product Weight
9608N	082171096082	Carded	8 mm	0.768 in	0.197 in	0.665 in	0.272 in	5.433 in	0.10 lb
9609N	082171096099	Carded	9 mm	0.768 in	0.213 in	0.701 in	0.272 in	5.795 in	0.11 lb
9610N	082171096105	Carded	10 mm	0.862 in	0.224 in	0.780 in	0.303 in	6.169 in	0.14 lb
9611N	082171096112	Carded	11 mm	0.953 in	0.252 in	0.854 in	0.323 in	6.413 in	0.15 lb
9612N	082171096129	Carded	12 mm	1.047 in	0.291 in	0.906 in	0.339 in	6.657 in	0.37 lb
9613N	082171096136	Carded	13 mm	1.146 in	0.319 in	0.984 in	0.339 in	6.902 in	0.23 lb
9614N	082171096143	Carded	14 mm	1.228 in	0.327 in	1.035 in	0.370 in	7.398 in	0.26 lb
9615N	082171096150	Carded	15 mm	1.327 in	0.327 in	1.130 in	0.390 in	7.748 in	0.30 lb
9616N	082171096167	Carded	16 mm	1.358 in	0.346 in	1.201 in	0.406 in	8.087 in	0.40 lb
9617N	082171096174	Carded	17 mm	1.492 in	0.362 in	1.272 in	0.421 in	8.740 in	0.42 lb
9618N	082171096181	Carded	18 mm	1.583 in	0.370 in	1.307 in	0.441 in	9.169 in	0.45 lb
9619N	082171096198	Carded	19 mm	1.626 in	0.374 in	1.339 in	0.441 in	9.594 in	0.54 lb
9621N	082171096211	Carded	21 mm	1.811 in	0.390 in	1.535 in	0.512 in	11.476 in	0.88 lb
9622N	082171096228	Carded	22 mm	1.811 in	0.390 in	1.535 in	0.512 in	11.476 in	1.01 lb
9624N	082171096242	Carded	24 mm	2.055 in	0.429 in	1.791 in	0.571 in	14.000 in	1.15 lb
9625N	082171096259	Carded	25 mm	2.055 in	0.429 in	1.791 in	0.571 in	14.000 in	1.27 lb

GEARWRENCH® 12 Pc. 12 Point Metric XL Locking Flex Ratcheting Wrench Set

- Locking Flexible Head
- 72 Teeth Ratcheting Box End Needs As Little As 5° to Move Fasteners Versus 30° for Standard Box End Wrenches
- Surface Drive® on Box End Provides Off-Corner Loading for Better Grip and Reduced Fastener Rounding



Cat. No.	UPC No.	Packaging	Product Weight
85698	082171856983	Carded	4.35 lb

Cat. No.	Description	Cat. No.	Description
85608	8mm XL Locking Flex-Head Ratcheting Combination Wrench	85614	14mm XL Locking Flex-Head Ratcheting Combination Wrench
85609	9mm XL Locking Flex-Head Ratcheting Combination Wrench	85615	15mm XL Locking Flex-Head Ratcheting Combination Wrench
85610	10mm XL Locking Flex-Head Ratcheting Combination Wrench	85616	16mm XL Locking Flex-Head Ratcheting Combination Wrench
85611	11mm XL Locking Flex-Head Ratcheting Combination Wrench	85617	17mm XL Locking Flex-Head Ratcheting Combination Wrench
85612	12mm XL Locking Flex-Head Ratcheting Combination Wrench	85618	18mm XL Locking Flex-Head Ratcheting Combination Wrench
85613	13mm XL Locking Flex-Head Ratcheting Combination Wrench	85619	19mm XL Locking Flex-Head Ratcheting Combination Wrench

GEARWRENCH® 12 Pc. 12 Point Metric XL Locking Flex Ratcheting Wrench Set with Wrench Roll

- Locking Flexible Head
- 72 Teeth Ratcheting Box End Needs As Little As 5° to Move Fasteners Versus 30° for Standard Box End Wrenches
- Surface Drive® on Box End Provides Off-Corner Loading for Better Grip and Reduced Fastener Rounding



Cat. No.	UPC No.	Packaging	Product Weight
85698R	082171856907	Pouch	4.40 lb

Cat. No.	Description	Cat. No.	Description
85608	8mm XL Locking Flex-Head Ratcheting Combination Wrench	85614	14mm XL Locking Flex-Head Ratcheting Combination Wrench
85609	9mm XL Locking Flex-Head Ratcheting Combination Wrench	85615	15mm XL Locking Flex-Head Ratcheting Combination Wrench
85610	10mm XL Locking Flex-Head Ratcheting Combination Wrench	85616	16mm XL Locking Flex-Head Ratcheting Combination Wrench
85611	11mm XL Locking Flex-Head Ratcheting Combination Wrench	85617	17mm XL Locking Flex-Head Ratcheting Combination Wrench
85612	12mm XL Locking Flex-Head Ratcheting Combination Wrench	85618	18mm XL Locking Flex-Head Ratcheting Combination Wrench
85613	13mm XL Locking Flex-Head Ratcheting Combination Wrench	85619	19mm XL Locking Flex-Head Ratcheting Combination Wrench

GEARWRENCH® 8 Pc. 12 Point SAE XL Locking Flex Ratcheting Wrench Set

- Locking Flexible Head
- 72 Teeth Ratcheting Box End Needs As Little As 5° to Move Fasteners Versus 30° for Standard Box End Wrenches
- Surface Drive® on Box End Provides Off-Corner Loading for Better Grip and Reduced Fastener Rounding



Cat. No.	UPC No.	Packaging	Product Weight
85798	082171857980	Carded	2.69 lb

Cat. No.	Description	Cat. No.	Description
85710	5/16" Flex-Head Combination Ratcheting Wrench	85718	9/16" Flex-Head Combination Ratcheting Wrench
85712	3/8" Flex-Head Combination Ratcheting Wrench	85720	5/8" Flex-Head Combination Ratcheting Wrench
85714D	7/16" Flex-Head Combination Ratcheting Wrench	85722	11/16" Flex-Head Combination Ratcheting Wrench
85716	1/2" Flex-Head Combination Ratcheting Wrench	85724D	3/4" Flex-Head Combination Ratcheting Wrench

GEARWRENCH® 8 Pc. 12 Point SAE XL Locking Flex Ratcheting Wrench Set with Wrench Roll

- Locking Flexible Head
- 72 Teeth Ratcheting Box End Needs As Little As 5° to Move Fasteners Versus 30° for Standard Box End Wrenches
- Surface Drive® on Box End Provides Off-Corner Loading for Better Grip and Reduced Fastener Rounding



Cat. No.	UPC No.	Packaging	Product Weight
85798R	082171857997	Pouch	2.80 lb

Cat. No.	Description	Cat. No.	Description
85710	5/16" Flex-Head Combination Ratcheting Wrench	85718	9/16" Flex-Head Combination Ratcheting Wrench
85712	3/8" Flex-Head Combination Ratcheting Wrench	85720	5/8" Flex-Head Combination Ratcheting Wrench
85714D	7/16" Flex-Head Combination Ratcheting Wrench	85722	11/16" Flex-Head Combination Ratcheting Wrench
85716	1/2" Flex-Head Combination Ratcheting Wrench	85724D	3/4" Flex-Head Combination Ratcheting Wrench

GEARWRENCH® 12 Point SAE XL Locking Flex Ratcheting Wrenches

- Locking Flexible Head
- 72 Teeth Ratcheting Box End Needs As Little As 5° to Move Fasteners Versus 30° for Standard Box End Wrenches
- Surface Drive® on Box End Provides Off-Corner Loading for Better Grip and Reduced Fastener Rounding



Cat. No.	UPC No.	Packaging	Fastener Size	End A Width	End A Thickness	End B Width	End B Thickness	Overall Length	Product Weight
85710	082171857102	Carded	5/16 in	0.770 in	0.980 in	0.670 in	0.270 in	5.750 in	0.13 lb
85712	082171857126	Carded	3/8 in	0.860 in	1.040 in	0.780 in	0.300 in	6.730 in	0.17 lb
85714D	082171857140	Carded	7/16 in	0.950 in	0.250 in	0.850 in	0.320 in	7.200 in	0.26 lb
85716	082171857164	Carded	1/2 in	1.150 in	0.320 in	0.980 in	0.340 in	8.150 in	0.29 lb
85718	082171857188	Carded	9/16 in	1.230 in	0.670 in	1.040 in	0.370 in	8.620 in	0.36 lb
85720	082171857201	Carded	5/8 in	1.360 in	0.700 in	1.200 in	0.410 in	9.530 in	0.44 lb
85722	082171857225	Carded	11/16 in	1.490 in	0.780 in	1.270 in	0.420 in	10.000 in	0.56 lb
85724D	082171857249	Carded	3/4 in	1.630 in	0.850 in	1.340 in	0.440 in	11.020 in	0.56 lb

GEARWRENCH® 12 Point Metric XL Locking Flex Ratcheting Wrenches

- Locking Flexible Head
- 72 Teeth Ratcheting Box End Needs As Little As 5° to Move Fasteners Versus 30° for Standard Box End Wrenches
- Surface Drive® on Box End Provides Off-Corner Loading for Better Grip and Reduced Fastener Rounding



Cat. No.	UPC No.	Packaging	Fastener Size	End A Width	End A Thickness	End B Width	End B Thickness	Overall Length	Product Weight
85608	082171856082	Carded	8 mm	0.770 in	0.200 in	0.670 in	0.270 in	5.750 in	0.12 lb
85609	082171856099	Carded	9 mm	0.770 in	0.210 in	0.700 in	0.270 in	6.260 in	0.14 lb
85610	082171856105	Carded	10 mm	0.860 in	0.220 in	0.780 in	0.300 in	6.730 in	0.18 lb
85611	082171856112	Carded	11 mm	0.950 in	0.250 in	0.850 in	0.320 in	7.200 in	0.21 lb
85612	082171856129	Carded	12 mm	1.050 in	0.290 in	0.910 in	0.340 in	7.680 in	0.26 lb
85613	082171856136	Carded	13 mm	1.150 in	0.320 in	0.980 in	0.340 in	8.150 in	0.29 lb
85614	082171856143	Carded	14 mm	1.230 in	0.330 in	1.040 in	0.370 in	8.620 in	0.36 lb
85615	082171856150	Carded	15 mm	1.330 in	0.330 in	1.130 in	0.390 in	9.090 in	0.41 lb
85616	082171856167	Carded	16 mm	1.360 in	0.350 in	1.200 in	0.410 in	9.530 in	0.49 lb
85617	082171856174	Carded	17 mm	1.490 in	0.360 in	1.270 in	0.420 in	10.000 in	0.56 lb
85618	082171856181	Carded	18 mm	1.580 in	0.370 in	1.310 in	0.440 in	10.510 in	0.62 lb
85619	082171856198	Carded	19 mm	1.630 in	0.370 in	1.340 in	0.440 in	11.020 in	0.72 lb

GEARWRENCH® 16 Pc. 12 Point Metric Flex Combination Ratcheting Wrench Set

- Flexible Head
- Knurled Side Beam for Ratcheting Direction Indicator
- 72 Teeth Ratcheting Box End Needs As Little As 5° to Move Fasteners Versus 30° for Standard Box End Wrenches
- Surface Drive® on Box End Provides Off-Corner Loading for Better Grip and Reduced Fastener Rounding



Cat. No.	UPC No.	Packaging	Product Weight
9902D	082171099021	Carded	9.00 lb

Cat. No.	Description	Cat. No.	Description
9908D	8mm Flex-Head Combination Ratcheting Wrench	9916D	16mm Flex-Head Combination Ratcheting Wrench
9909D	9mm Flex-Head Combination Ratcheting Wrench	9917	17mm Flex-Head Combination Ratcheting Wrench
9910D	10mm Flex-Head Combination Ratcheting Wrench	9918	18mm Flex-Head Combination Ratcheting Wrench
9911D	11mm Flex-Head Combination Ratcheting Wrench	9919D	19mm Flex-Head Combination Ratcheting Wrench
9912D	12mm Flex-Head Combination Ratcheting Wrench	9921D	21mm Flex-Head Combination Ratcheting Wrench
9913D	13mm Flex-Head Combination Ratcheting Wrench	9922D	22mm Flex-Head Combination Ratcheting Wrench
9914D	14mm Flex-Head Combination Ratcheting Wrench	9924D	24mm Flex-Head Combination Ratcheting Wrench
9915D	15mm Flex-Head Combination Ratcheting Wrench	9925D	25mm Flex-Head Combination Ratcheting Wrench

GEARWRENCH® 13 Pc. 12 Point SAE Flex Combination Ratcheting Wrench Set

- Flexible Head
- Knurled Side Beam for Ratcheting Direction Indicator
- 72 Teeth Ratcheting Box End Needs As Little As 5° to Move Fasteners Versus 30° for Standard Box End Wrenches
- Surface Drive® on Box End Provides Off-Corner Loading for Better Grip and Reduced Fastener Rounding



Cat. No.	UPC No.	Packaging	Product Weight
9702D	082171097027	Carded	7.20 lb

Cat. No.	Description	Cat. No.	Description
9705	5/16" Flex-Head Combination Ratcheting Wrench	9711	11/16" Flex-Head Combination Ratcheting Wrench
9704D	11/32" Flex-Head Combination Ratcheting Wrench	9712	3/4" Flex-Head Combination Ratcheting Wrench
9706	3/8" Flex-Head Combination Ratcheting Wrench	9713	13/16" Flex-Head Combination Ratcheting Wrench
9707	7/16" Flex-Head Combination Ratcheting Wrench	9714D	7/8" Flex-Head Combination Ratcheting Wrench
9708	1/2" Flex-Head Combination Ratcheting Wrench	9715D	15/16" Flex-Head Combination Ratcheting Wrench
9709	9/16" Flex-Head Combination Ratcheting Wrench	9716D	1" Flex-Head Combination Ratcheting Wrench
9710	5/8" Flex-Head Combination Ratcheting Wrench		

GEARWRENCH® 12 Pc. 12 Point Metric Flex Combination Ratcheting Wrench Set

- Flexible Head
- Knurled Side Beam for Ratcheting Direction Indicator
- 72 Teeth Ratcheting Box End Needs As Little As 5° to Move Fasteners Versus 30° for Standard Box End Wrenches
- Surface Drive® on Box End Provides Off-Corner Loading for Better Grip and Reduced Fastener Rounding



Cat. No.	UPC No.	Packaging	Product Weight
9901D	082171099014	Carded	6.80 lb

Cat. No.	Description	Cat. No.	Description
9908D	8mm Flex-Head Combination Ratcheting Wrench	9914D	14mm Flex-Head Combination Ratcheting Wrench
9909D	9mm Flex-Head Combination Ratcheting Wrench	9915D	15mm Flex-Head Combination Ratcheting Wrench
9910D	10mm Flex-Head Combination Ratcheting Wrench	9916D	16mm Flex-Head Combination Ratcheting Wrench
9911D	11mm Flex-Head Combination Ratcheting Wrench	9917	17mm Flex-Head Combination Ratcheting Wrench
9912D	12mm Flex-Head Combination Ratcheting Wrench	9918	18mm Flex-Head Combination Ratcheting Wrench
9913D	13mm Flex-Head Combination Ratcheting Wrench	9919D	19mm Flex-Head Combination Ratcheting Wrench

GEARWRENCH® 8 Pc. 12 Point SAE Flex Combination Ratcheting Wrench Set

- Flexible Head
- Knurled Side Beam for Ratcheting Direction Indicator
- 72 Teeth Ratcheting Box End Needs As Little As 5° to Move Fasteners Versus 30° for Standard Box End Wrenches
- Surface Drive® on Box End Provides Off-Corner Loading for Better Grip and Reduced Fastener Rounding

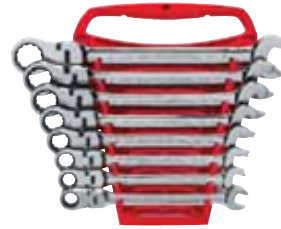

Cat. No.	UPC No.	Packaging	Product Weight
9701	082171097010	Carded	2.46 lb

Cat. No.	Description	Cat. No.	Description
9705	5/16" Flex-Head Combination Ratcheting Wrench	9709	9/16" Flex-Head Combination Ratcheting Wrench
9706	3/8" Flex-Head Combination Ratcheting Wrench	9710	5/8" Flex-Head Combination Ratcheting Wrench
9707	7/16" Flex-Head Combination Ratcheting Wrench	9711	11/16" Flex-Head Combination Ratcheting Wrench
9708	1/2" Flex-Head Combination Ratcheting Wrench	9712	3/4" Flex-Head Combination Ratcheting Wrench

GEARWRENCH® 7 Pc. 12 Point SAE Flex Combination Ratcheting Wrench Set

- Flexible Head
- Knurled Side Beam for Ratcheting Direction Indicator
- 72 Teeth Ratcheting Box End Needs As Little As 5° to Move Fasteners Versus 30° for Standard Box End Wrenches
- Surface Drive® on Box End Provides Off-Corner Loading for Better Grip and Reduced Fastener Rounding



Cat. No.	UPC No.	Packaging	Product Weight
9700	082171097003	Carded	2.86 lb

Cat. No.	Description	Cat. No.	Description
9706	3/8" Flex-Head Combination Ratcheting Wrench	9710	5/8" Flex-Head Combination Ratcheting Wrench
9707	7/16" Flex-Head Combination Ratcheting Wrench	9711	11/16" Flex-Head Combination Ratcheting Wrench
9708	1/2" Flex-Head Combination Ratcheting Wrench	9712	3/4" Flex-Head Combination Ratcheting Wrench
9709	9/16" Flex-Head Combination Ratcheting Wrench		

GEARWRENCH® 7 Pc. 12 Point Metric Flex Combination Ratcheting Wrench Set

- Flexible Head
- Knurled Side Beam for Ratcheting Direction Indicator
- 72 Teeth Ratcheting Box End Needs As Little As 5° to Move Fasteners Versus 30° for Standard Box End Wrenches
- Surface Drive® on Box End Provides Off-Corner Loading for Better Grip and Reduced Fastener Rounding



Cat. No.	UPC No.	Packaging	Product Weight
9900D	082171099007	Carded	2.86 lb

Cat. No.	Description	Cat. No.	Description
9910D	10mm Flex-Head Combination Ratcheting Wrench	9915D	15mm Flex-Head Combination Ratcheting Wrench
9912D	12mm Flex-Head Combination Ratcheting Wrench	9917	17mm Flex-Head Combination Ratcheting Wrench
9913D	13mm Flex-Head Combination Ratcheting Wrench	9919D	19mm Flex-Head Combination Ratcheting Wrench
9914D	14mm Flex-Head Combination Ratcheting Wrench		

GEARWRENCH® 4 Pc. 12 Point SAE Flex Combination Ratcheting Wrench Set

- Flexible Head
- Knurled Side Beam for Ratcheting Direction Indicator
- 72 Teeth Ratcheting Box End Needs As Little As 5° to Move Fasteners Versus 30° for Standard Box End Wrenches
- Surface Drive® on Box End Provides Off-Corner Loading for Better Grip and Reduced Fastener Rounding



Cat. No.	UPC No.	Packaging	Product Weight
9703	082171970306	Carded	4.85 lb

Cat. No.	Description	Cat. No.	Description
9713	13/16" Flex-Head Combination Ratcheting Wrench	9715D	15/16" Flex-Head Combination Ratcheting Wrench
9714D	7/8" Flex-Head Combination Ratcheting Wrench	9716D	1" Flex-Head Combination Ratcheting Wrench

GEARWRENCH® 4 Pc. 12 Point Metric Flex Combination Ratcheting Wrench Set

- Flexible Head
- Knurled Side Beam for Ratcheting Direction Indicator
- 72 Teeth Ratcheting Box End Needs As Little As 5° to Move Fasteners Versus 30° for Standard Box End Wrenches
- Surface Drive® on Box End Provides Off-Corner Loading for Better Grip and Reduced Fastener Rounding



Cat. No.	UPC No.	Packaging	Product Weight
9903D	082171099038	Carded	4.85 lb

Cat. No.	Description	Cat. No.	Description
9921D	21mm Flex-Head Combination Ratcheting Wrench	9924D	24mm Flex-Head Combination Ratcheting Wrench
9922D	22mm Flex-Head Combination Ratcheting Wrench	9925D	25mm Flex-Head Combination Ratcheting Wrench

GEARWRENCH® 12 Point SAE Flex Combination Ratcheting Wrenches

- Flexible Head
- Knurled Side Beam for Ratcheting Direction Indicator
- 72 Teeth Ratcheting Box End Needs As Little As 5° to Move Fasteners Versus 30° for Standard Box End Wrenches
- Surface Drive® on Box End Provides Off-Corner Loading for Better Grip and Reduced Fastener Rounding



Cat. No.	UPC No.	Packaging	Fastener Size	End A Width	End A Thickness	End B Width	End B Thickness	Overall Length	Product Weight
9705	082171097058	Carded	5/16 in	0.768 in	0.197 in	0.665 in	0.272 in	5.508 in	0.12 lb
9704D	082171097041	Carded	11/32 in	0.768 in	0.213 in	0.701 in	0.272 in	5.882 in	0.14 lb
9706	082171097065	Carded	3/8 in	0.862 in	0.224 in	0.780 in	0.303 in	6.252 in	0.16 lb
9707	082171097072	Carded	7/16 in	0.953 in	0.252 in	0.854 in	0.323 in	6.504 in	0.18 lb
9708	082171097089	Carded	1/2 in	1.146 in	0.319 in	0.984 in	0.339 in	7.004 in	0.23 lb
9709	082171097096	Carded	9/16 in	1.228 in	0.327 in	1.035 in	0.370 in	7.504 in	0.26 lb
9710	082171097102	Carded	5/8 in	1.358 in	0.346 in	1.201 in	0.406 in	8.197 in	0.37 lb
9711	082171097119	Carded	11/16 in	1.492 in	0.362 in	1.272 in	0.421 in	8.878 in	0.55 lb
9712	082171097126	Carded	3/4 in	1.626 in	0.374 in	1.339 in	0.441 in	9.764 in	0.86 lb
9713	082171097133	Carded	13/16 in	1.811 in	0.390 in	1.535 in	0.512 in	11.476 in	1.00 lb
9714D	082171097140	Carded	7/8 in	1.811 in	0.390 in	1.535 in	0.512 in	11.476 in	1.14 lb
9715D	082171097157	Carded	15/16 in	2.055 in	0.429 in	1.791 in	0.571 in	13.114 in	1.29 lb
9716D	082171097164	Carded	1 in	2.055 in	0.429 in	1.791 in	0.571 in	13.114 in	1.32 lb

GEARWRENCH® 12 Point Metric Flex Combination Ratcheting Wrenches

- Flexible Head
- Knurled Side Beam for Ratcheting Direction Indicator
- 72 Teeth Ratcheting Box End Needs As Little As 5° to Move Fasteners Versus 30° for Standard Box End Wrenches
- Surface Drive® on Box End Provides Off-Corner Loading for Better Grip and Reduced Fastener Rounding



Cat. No.	UPC No.	Packaging	Fastener Size	End A Width	End A Thickness	End B Width	End B Thickness	Overall Length	Product Weight
9908D	082171099083	Carded	8 mm	0.768 in	0.197 in	0.665 in	0.272 in	5.508 in	0.12 lb
9909D	082171099090	Carded	9 mm	0.768 in	0.213 in	0.701 in	0.272 in	5.882 in	0.13 lb
9910D	082171099106	Carded	10 mm	0.862 in	0.224 in	0.780 in	0.303 in	6.252 in	0.14 lb
9911D	082171099113	Carded	11 mm	0.953 in	0.252 in	0.854 in	0.323 in	6.504 in	0.16 lb
9912D	082171099120	Carded	12 mm	1.047 in	0.291 in	0.906 in	0.339 in	6.756 in	0.19 lb
9913D	082171099137	Carded	13 mm	1.146 in	0.319 in	0.984 in	0.339 in	7.004 in	0.22 lb
9914D	082171099144	Carded	14 mm	1.228 in	0.327 in	1.035 in	0.370 in	7.504 in	0.27 lb
9915D	082171099151	Carded	15 mm	1.327 in	0.327 in	1.130 in	0.390 in	7.854 in	0.31 lb
9916D	082171099168	Carded	16 mm	1.358 in	0.346 in	1.201 in	0.406 in	8.197 in	0.36 lb
9917	082171099175	Carded	17 mm	1.492 in	0.362 in	1.272 in	0.421 in	8.878 in	0.43 lb
9918	082171099182	Carded	18 mm	1.583 in	0.370 in	1.307 in	0.441 in	9.315 in	0.51 lb
9919D	082171099199	Carded	19 mm	1.626 in	0.374 in	1.339 in	0.441 in	9.764 in	0.57 lb
9921D	082171099212	Carded	21 mm	1.811 in	0.390 in	1.535 in	0.512 in	11.476 in	0.99 lb
9922D	082171099229	Carded	22 mm	1.811 in	0.390 in	1.535 in	0.512 in	11.476 in	0.98 lb
9924D	082171099243	Carded	24 mm	2.055 in	0.429 in	1.791 in	0.571 in	13.114 in	1.38 lb
9925D	082171099250	Carded	25 mm	2.055 in	0.429 in	1.791 in	0.571 in	14.000 in	1.36 lb

GEARWRENCH® 10 Pc. 12 Point Metric Stubby Flex Combination Ratcheting Wrench Set

- Stubby Length for Tight Access Areas
- Flexible Head
- Knurled Side Beam for Ratcheting Direction Indicator
- 72 Teeth Ratcheting Box End Needs As Little As 5° to Move Fasteners Versus 30° for Standard Box End Wrenches
- Surface Drive® on Box End Provides Off-Corner Loading for Better Grip and Reduced Fastener Rounding



Cat. No.	UPC No.	Packaging	Product Weight
9550	082171095504	Carded	2.91 lb

Cat. No.	Description	Cat. No.	Description
9551	10mm Stubby Flex-Head Combination Ratcheting Wrench	9556	15mm Stubby Flex-Head Combination Ratcheting Wrench
9552	11mm Stubby Flex-Head Combination Ratcheting Wrench	9557D	16mm Stubby Flex-Head Combination Ratcheting Wrench
9553D	12mm Stubby Flex-Head Combination Ratcheting Wrench	9558	17mm Stubby Flex-Head Combination Ratcheting Wrench
9554	13mm Stubby Flex-Head Combination Ratcheting Wrench	9559	18mm Stubby Flex-Head Combination Ratcheting Wrench
9555	14mm Stubby Flex-Head Combination Ratcheting Wrench	9560	19mm Stubby Flex-Head Combination Ratcheting Wrench

GEARWRENCH® 7 Pc. 12 Point SAE Stubby Flex Combination Ratcheting Wrench Set

- Stubby Length for Tight Access Areas
- Flexible Head
- Knurled Side Beam for Ratcheting Direction Indicator
- 72 Teeth Ratcheting Box End Needs As Little As 5° to Move Fasteners Versus 30° for Standard Box End Wrenches
- Surface Drive® on Box End Provides Off-Corner Loading for Better Grip and Reduced Fastener Rounding



Cat. No.	UPC No.	Packaging	Product Weight
9570	082171095702	Carded	2.20 lb

Cat. No.	Description	Cat. No.	Description
9571	3/8" Stubby Flex-Head Combination Ratcheting Wrench	9575	5/8" Stubby Flex-Head Combination Ratcheting Wrench
9572	7/16" Stubby Flex-Head Combination Ratcheting Wrench	9576	11/16" Stubby Flex-Head Combination Ratcheting Wrench
9573	1/2" Stubby Flex-Head Combination Ratcheting Wrench	9577	3/4" Stubby Flex-Head Combination Ratcheting Wrench
9574	9/16" Stubby Flex-Head Combination Ratcheting Wrench		

GEARWRENCH® 12 Point SAE Stubby Flex Combination Ratcheting Wrenches

- Stubby Length for Tight Access Areas
- Flexible Head
- Knurled Side Beam for Ratcheting Direction Indicator
- 72 Teeth Ratcheting Box End Needs As Little As 5° to Move Fasteners Versus 30° for Standard Box End Wrenches
- Surface Drive® on Box End Provides Off-Corner Loading for Better Grip and Reduced Fastener Rounding



Cat. No.	UPC No.	Packaging	Fastener Size	End A Width	End A Thickness	End B Width	End B Thickness	Overall Length	Product Weight
9571	082171095719	Carded	3/8 in	0.862 in	0.224 in	0.780 in	0.303 in	3.701 in	0.10 lb
9572	082171095726	Carded	7/16 in	0.953 in	0.252 in	0.854 in	0.323 in	4.016 in	0.20 lb
9573	082171095733	Carded	1/2 in	1.146 in	0.319 in	0.984 in	0.339 in	4.213 in	0.20 lb
9574	082171095740	Carded	9/16 in	1.228 in	0.327 in	1.035 in	0.370 in	4.488 in	0.20 lb
9575	082171095757	Carded	5/8 in	1.358 in	0.346 in	1.201 in	0.406 in	4.803 in	0.30 lb
9576	082171095764	Carded	11/16 in	1.492 in	0.362 in	1.272 in	0.421 in	4.961 in	0.40 lb
9577	082171095771	Carded	3/4 in	1.626 in	0.374 in	1.339 in	0.441 in	5.433 in	0.40 lb

GEARWRENCH® 12 Point Metric Stubby Flex Combination Ratcheting Wrenches

- Stubby Length for Tight Access Areas
- Flexible Head
- Knurled Side Beam for Ratcheting Direction Indicator
- 72 Teeth Ratcheting Box End Needs As Little As 5° to Move Fasteners Versus 30° for Standard Box End Wrenches
- Surface Drive® on Box End Provides Off-Corner Loading for Better Grip and Reduced Fastener Rounding



Cat. No.	UPC No.	Packaging	Fastener Size	End A Width	End A Thickness	End B Width	End B Thickness	Overall Length	Product Weight
9551	082171095511	Carded	10 mm	0.862 in	0.224 in	0.780 in	0.303 in	3.701 in	0.11 lb
9552	082171095528	Carded	11 mm	0.953 in	0.252 in	0.854 in	0.323 in	4.016 in	0.12 lb
9553D	082171095535	Carded	12 mm	1.047 in	0.291 in	0.906 in	0.339 in	4.134 in	0.15 lb
9554	082171095542	Carded	13 mm	1.146 in	0.319 in	0.984 in	0.339 in	4.213 in	0.17 lb
9555	082171095559	Carded	14 mm	1.228 in	0.327 in	1.035 in	0.370 in	4.488 in	0.21 lb
9556	082171095566	Carded	15 mm	1.327 in	0.327 in	1.130 in	0.390 in	4.646 in	0.24 lb
9557D	082171095573	Carded	16 mm	1.358 in	0.346 in	1.201 in	0.406 in	4.803 in	0.27 lb
9558	082171095580	Carded	17 mm	1.492 in	0.362 in	1.272 in	0.421 in	4.961 in	0.32 lb
9559	082171095597	Carded	18 mm	1.583 in	0.370 in	1.307 in	0.441 in	5.118 in	0.37 lb
9560	082171095603	Carded	19 mm	1.626 in	0.374 in	1.339 in	0.441 in	5.433 in	0.41 lb

GEARWRENCH® 12 Pc. 12 Point Metric XL GearBox™ Double Box Ratcheting Wrench Set

- XL GearBox™ Design Has a Longer Beam to Increase Leverage and Torque
- Non-Ratcheting End for Breaking Loose Stubborn Fasteners
- 0° Offset and Slim Profile to Access the Tightest Spaces and Recessed Fasteners
- Surface Drive® on Box End Provides Off-Corner Loading for Better Grip and Reduced Fastener Rounding



Cat. No.	UPC No.	Packaging	Product Weight
85988	082171859885	Blow Mold Tray	6.38 lb

Cat. No.	Description	Cat. No.	Description
85908	8mm 12 Point Full Polish XL GearBox™ Ratcheting Wrench	85914	14mm 12 Point Full Polish XL GearBox™ Ratcheting Wrench
85909	9mm 12 Point Full Polish XL GearBox™ Ratcheting Wrench	85915	15mm 12 Point Full Polish XL GearBox™ Ratcheting Wrench
85910	10mm 12 Point Full Polish XL GearBox™ Ratcheting Wrench	85916	16mm 12 Point Full Polish XL GearBox™ Ratcheting Wrench
85911	11mm 12 Point Full Polish XL GearBox™ Ratcheting Wrench	85917	17mm 12 Point Full Polish XL GearBox™ Ratcheting Wrench
85912	12mm 12 Point Full Polish XL GearBox™ Ratcheting Wrench	85918	18mm 12 Point Full Polish XL GearBox™ Ratcheting Wrench
85913	13mm 12 Point Full Polish XL GearBox™ Ratcheting Wrench	85919	19mm 12 Point Full Polish XL GearBox™ Ratcheting Wrench

GEARWRENCH® 17 Pc. 12 Point Metric XL GearBox™ Double Box Ratcheting Wrench Set

- XL GearBox™ Design Has a Longer Beam to Increase Leverage and Torque
- Non-Ratcheting End for Breaking Loose Stubborn Fasteners
- 0° Offset and Slim Profile to Access the Tightest Spaces and Recessed Fasteners
- Surface Drive® on Box End Provides Off-Corner Loading for Better Grip and Reduced Fastener Rounding



Cat. No.	UPC No.	Packaging	Product Weight
85989	082171859892	Blow Mold Tray	13.10 lb

Cat. No.	Description	Cat. No.	Description
85908	8mm 12 Point Full Polish XL GearBox™ Ratcheting Wrench	85917	17mm 12 Point Full Polish XL GearBox™ Ratcheting Wrench
85909	9mm 12 Point Full Polish XL GearBox™ Ratcheting Wrench	85918	18mm 12 Point Full Polish XL GearBox™ Ratcheting Wrench
85910	10mm 12 Point Full Polish XL GearBox™ Ratcheting Wrench	85919	19mm 12 Point Full Polish XL GearBox™ Ratcheting Wrench
85911	11mm 12 Point Full Polish XL GearBox™ Ratcheting Wrench	85920	20mm 12 Point Full Polish XL GearBox™ Ratcheting Wrench
85912	12mm 12 Point Full Polish XL GearBox™ Ratcheting Wrench	85921	21mm 12 Point Full Polish XL GearBox™ Ratcheting Wrench
85913	13mm 12 Point Full Polish XL GearBox™ Ratcheting Wrench	85922	22mm 12 Point Full Polish XL GearBox™ Ratcheting Wrench
85914	14mm 12 Point Full Polish XL GearBox™ Ratcheting Wrench	85924	24mm 12 Point Full Polish XL GearBox™ Ratcheting Wrench
85915	15mm 12 Point Full Polish XL GearBox™ Ratcheting Wrench	85925	25mm 12 Point Full Polish XL GearBox™ Ratcheting Wrench
85916	16mm 12 Point Full Polish XL GearBox™ Ratcheting Wrench		

GEARWRENCH 5 Pc. 12 Point Metric XL GearBox™ Double Box Ratcheting Wrench Set

- XL GearBox™ Design Has a Longer Beam to Increase Leverage and Torque
- Non-Ratcheting End for Breaking Loose Stubborn Fasteners
- 0° Offset and Slim Profile to Access the Tightest Spaces and Recessed Fasteners
- Surface Drive® on Box End Provides Off-Corner Loading for Better Grip and Reduced Fastener Rounding



Cat. No.	UPC No.	Packaging	Product Weight
85987	082171859878	Blow Mold Tray	7.84 lb

Cat. No.	Description	Cat. No.	Description
85920	20mm 12 Point Full Polish XL GearBox™ Ratcheting Wrench	85924	24mm 12 Point Full Polish XL GearBox™ Ratcheting Wrench
85921	21mm 12 Point Full Polish XL GearBox™ Ratcheting Wrench	85925	25mm 12 Point Full Polish XL GearBox™ Ratcheting Wrench
85922	22mm 12 Point Full Polish XL GearBox™ Ratcheting Wrench		

GEARWRENCH 13 Pc. 12 Point SAE XL GearBox™ Double Box Ratcheting Wrench Set

- XL GearBox™ Design Has a Longer Beam to Increase Leverage and Torque
- Non-Ratcheting End for Breaking Loose Stubborn Fasteners
- 0° Offset and Slim Profile to Access the Tightest Spaces and Recessed Fasteners
- Surface Drive® on Box End Provides Off-Corner Loading for Better Grip and Reduced Fastener Rounding



Cat. No.	UPC No.	Packaging	Product Weight
85999	082171859991	Blow Mold Tray	10.56 lb

Cat. No.	Description	Cat. No.	Description
85950	5/16" 12 Point Full Polish XL GearBox™ Ratcheting Wrench	85962	11/16" 12 Point Full Polish XL GearBox™ Ratcheting Wrench
85951	11/32" 12 Point Full Polish XL GearBox™ Ratcheting Wrench	85964	3/4" 12 Point Full Polish XL GearBox™ Ratcheting Wrench
85952	3/8" 12 Point Full Polish XL GearBox™ Ratcheting Wrench	85966	13/16" 12 Point Full Polish XL GearBox™ Ratcheting Wrench
85954	7/16" 12 Point Full Polish XL GearBox™ Ratcheting Wrench	85968	7/8" 12 Point Full Polish XL GearBox™ Ratcheting Wrench
85956	1/2" 12 Point Full Polish XL GearBox™ Ratcheting Wrench	85970	15/16" 12 Point Full Polish XL GearBox™ Ratcheting Wrench
85958	9/16" 12 Point Full Polish XL GearBox™ Ratcheting Wrench	85972	1" 12 Point Full Polish XL GearBox™ Ratcheting Wrench
85960	5/8" 12 Point Full Polish XL GearBox™ Ratcheting Wrench		

GEARWRENCH® 9 Pc. 12 Point SAE XL GearBox™ Double Box Ratcheting Wrench Set

- XL GearBox™ Design Has a Longer Beam to Increase Leverage and Torque
- Non-Ratcheting End for Breaking Loose Stubborn Fasteners
- 0° Offset and Slim Profile to Access the Tightest Spaces and Recessed Fasteners
- Surface Drive® on Box End Provides Off-Corner Loading for Better Grip and Reduced Fastener Rounding



Cat. No.	UPC No.	Packaging	Product Weight
85998	082171859984	Blow Mold Tray	4.75 lb

Cat. No.	Description	Cat. No.	Description
85950	5/16" 12 Point Full Polish XL GearBox™ Ratcheting Wrench	85958	9/16" 12 Point Full Polish XL GearBox™ Ratcheting Wrench
85951	11/32" 12 Point Full Polish XL GearBox™ Ratcheting Wrench	85960	5/8" 12 Point Full Polish XL GearBox™ Ratcheting Wrench
85952	3/8" 12 Point Full Polish XL GearBox™ Ratcheting Wrench	85962	11/16" 12 Point Full Polish XL GearBox™ Ratcheting Wrench
85954	7/16" 12 Point Full Polish XL GearBox™ Ratcheting Wrench	85964	3/4" 12 Point Full Polish XL GearBox™ Ratcheting Wrench
85956	1/2" 12 Point Full Polish XL GearBox™ Ratcheting Wrench		

GEARWRENCH® 4 Pc. 12 Point SAE XL GearBox™ Double Box Ratcheting Wrench Set

- XL GearBox™ Design Has a Longer Beam to Increase Leverage and Torque
- Non-Ratcheting End for Breaking Loose Stubborn Fasteners
- 0° Offset and Slim Profile to Access the Tightest Spaces and Recessed Fasteners
- Surface Drive® on Box End Provides Off-Corner Loading for Better Grip and Reduced Fastener Rounding



Cat. No.	UPC No.	Packaging	Product Weight
85996	082171859960	Blow Mold Tray	3.38 lb

Cat. No.	Description	Cat. No.	Description
85966	13/16" 12 Point Full Polish XL GearBox™ Ratcheting Wrench	85970	15/16" 12 Point Full Polish XL GearBox™ Ratcheting Wrench
85968	7/8" 12 Point Full Polish XL GearBox™ Ratcheting Wrench	85972	1" 12 Point Full Polish XL GearBox™ Ratcheting Wrench

GEARWRENCH® 12 Point SAE XL GearBox™ Double Box Ratcheting Wrenches

- XL GearBox™ Design Has a Longer Beam to Increase Leverage and Torque
- Non-Ratcheting End for Breaking Loose Stubborn Fasteners
- 0° Offset and Slim Profile to Access the Tightest Spaces and Recessed Fasteners
- Surface Drive® on Box End Provides Off-Corner Loading for Better Grip and Reduced Fastener Rounding



Cat. No.	UPC No.	Packaging	Fastener Size	End A Width	End A Thickness	End B Width	End B Thickness	Overall Length	Product Weight
85950	082171859502	Carded	5/16 in	0.670 in	0.270 in	0.460 in	0.240 in	8.710 in	0.13 lb
85951	082171859519	Carded	11/32 in	0.700 in	0.270 in	0.520 in	0.260 in	8.910 in	0.13 lb
85952	082171859526	Carded	3/8 in	0.780 in	0.300 in	0.570 in	0.270 in	9.500 in	0.17 lb
85954	082171859540	Carded	7/16 in	0.850 in	0.320 in	0.620 in	0.310 in	9.890 in	0.20 lb
85956	082171859564	Carded	1/2 in	0.980 in	0.340 in	0.740 in	0.350 in	11.310 in	0.26 lb
85958	082171859588	Carded	9/16 in	1.040 in	0.370 in	0.800 in	0.390 in	12.020 in	0.38 lb
85960	082171859601	Carded	5/8 in	1.200 in	0.410 in	0.900 in	0.430 in	13.710 in	0.50 lb
85962	082171859625	Carded	11/16 in	1.270 in	0.420 in	0.940 in	0.430 in	14.700 in	0.67 lb
85964	082171859649	Carded	3/4 in	1.340 in	0.440 in	1.040 in	0.470 in	15.600 in	0.77 lb
85966	082171859663	Carded	13/16 in	1.540 in	0.510 in	1.180 in	0.570 in	16.540 in	1.42 lb
85968	082171859687	Carded	7/8 in	1.540 in	0.510 in	1.220 in	0.570 in	17.010 in	2.07 lb
85970	082171859700	Carded	15/16 in	1.750 in	0.570 in	1.340 in	0.590 in	18.030 in	2.71 lb
85972	082171859724	Carded	1 in	1.750 in	0.570 in	1.420 in	0.590 in	18.500 in	3.36 lb

GEARWRENCH® 12 Point Metric XL GearBox™ Double Box Ratcheting Wrenches

- XL GearBox™ Design Has a Longer Beam to Increase Leverage and Torque
- Non-Ratcheting End for Breaking Loose Stubborn Fasteners
- 0° Offset and Slim Profile to Access the Tightest Spaces and Recessed Fasteners
- Surface Drive® on Box End Provides Off-Corner Loading for Better Grip and Reduced Fastener Rounding



Cat. No.	UPC No.	Packaging	Fastener Size	End A Width	End A Thickness	End B Width	End B Thickness	Overall Length	Product Weight
85908	082171859083	Carded	8 mm	0.670 in	0.270 in	0.460 in	0.240 in	8.710 in	0.13 lb
85909	082171859090	Carded	9 mm	0.700 in	0.270 in	0.520 in	0.260 in	8.910 in	0.13 lb
85910	082171859106	Carded	10 mm	0.780 in	0.300 in	0.570 in	0.270 in	9.500 in	0.17 lb
85911	082171859113	Carded	11 mm	0.850 in	0.320 in	0.620 in	0.310 in	9.890 in	0.20 lb
85912	082171859120	Carded	12 mm	0.910 in	0.340 in	0.680 in	0.330 in	10.520 in	0.26 lb
85913	082171859137	Carded	13 mm	0.980 in	0.340 in	0.740 in	0.350 in	11.310 in	0.33 lb
85914	082171859144	Carded	14 mm	1.040 in	0.370 in	0.800 in	0.390 in	12.020 in	0.38 lb
85915	082171859151	Carded	15 mm	1.130 in	0.390 in	0.860 in	0.430 in	12.720 in	0.47 lb
85916	082171859168	Carded	16 mm	1.200 in	0.410 in	0.900 in	0.430 in	13.710 in	0.50 lb
85917	082171859175	Carded	17 mm	1.270 in	0.420 in	0.940 in	0.430 in	14.700 in	0.67 lb
85918	082171859182	Carded	18 mm	1.310 in	0.440 in	0.980 in	0.450 in	15.130 in	0.70 lb
85919	082171859199	Carded	19 mm	1.340 in	0.440 in	1.040 in	0.470 in	15.600 in	0.77 lb
85920	082171859205	Carded	20 mm	1.540 in	0.510 in	1.140 in	0.520 in	15.980 in	1.42 lb
85921	082171859212	Carded	21 mm	1.540 in	0.510 in	1.180 in	0.570 in	16.540 in	2.07 lb
85922	082171859229	Carded	22 mm	1.540 in	0.510 in	1.220 in	0.570 in	17.010 in	2.71 lb
85924	082171859243	Carded	24 mm	1.750 in	0.570 in	1.340 in	0.590 in	18.030 in	3.36 lb
85925	082171859250	Carded	25 mm	1.750 in	0.570 in	1.420 in	0.590 in	18.500 in	4.01 lb

GEARWRENCH® 9 Pc. 12 Point SAE XL Spline Combination Ratcheting Wrench Set with Wrench Roll

- Work on a Wide Assortment of Fasteners Including E-Torx®, Square, 6-Point, Rounded 6-Point, 12-Point and Spline
- Spline Combination Wrench
- XL Combination 20% Longer and 25% Stronger
- Ratcheting Box End Needs As Little As 5° to Move Fasteners vs. 30° for Standard Wrenches
- Bright, Full Polish Chrome Finish



Cat. No.	UPC No.	Packaging	Product Weight
85598	099575855986	Boxed	3.14 lb

Cat. No.	Description	Cat. No.	Description
85548	Spline Ratcheting Wrench #8 spline x 1/4"	85558D	Spline Ratcheting Wrench #18 spline x 9/16"
85550D	Spline Ratcheting Wrench #10 spline x 5/16"	85560	Spline Ratcheting Wrench #20 spline x 5/8"
85552D	Spline Ratcheting Wrench #12 spline x 3/8"	85562D	Spline Ratcheting Wrench #22 spline x 11/16"
85554D	Spline Ratcheting Wrench #14 spline x 7/16"	85564	Spline Ratcheting Wrench #24 spline x 3/4"
85556D	Spline Ratcheting Wrench #16 spline x 1/2"		

GEARWRENCH® 12 Point SAE XL Spline Combination Ratcheting Wrenches

- Work on a Wide Assortment of Fasteners Including E-Torx®, Square, 6-Point, Rounded 6-Point, 12-Point and Spline
- Spline Combination Wrench
- XL Combination 20% Longer and 25% Stronger
- Ratcheting Box End Needs As Little As 5° to Move Fasteners vs. 30° for Standard Wrenches
- Bright, Full Polish Chrome Finish



Cat. No.	UPC No.	Packaging	End A Fastener Size	End A Width	End A Thickness	End B Fastener Size	End B Width	End B Thickness	Overall Length	Product Weight
85548	099575855481	Carded	1/4 in	0.610 in	0.256 in	#8	0.567 in	0.181 in	5.315 in	0.07 lb
85550D	099575855504	Carded	5/16 in	0.665 in	0.272 in	#10	0.768 in	0.197 in	5.906 in	0.09 lb
85552D	099575855528	Carded	3/8 in	0.780 in	0.303 in	#12	0.862 in	0.224 in	7.087 in	0.14 lb
85554D	099575855542	Carded	7/16 in	0.854 in	0.323 in	#14	0.953 in	0.252 in	7.677 in	0.17 lb
85556D	099575855566	Carded	1/2 in	0.984 in	0.339 in	#16	1.146 in	0.319 in	8.661 in	0.26 lb
85558D	099575855580	Carded	9/16 in	1.035 in	0.370 in	#18	1.228 in	0.327 in	9.252 in	0.35 lb
85560	099575855603	Carded	5/8 in	1.201 in	0.406 in	#20	1.358 in	0.346 in	10.236 in	0.45 lb
85562D	099575855627	Carded	11/16 in	1.272 in	0.421 in	#22	1.492 in	0.362 in	10.827 in	0.49 lb
85564	099575855641	Carded	3/4 in	1.339 in	0.441 in	#24	1.626 in	0.374 in	12.008 in	0.67 lb

GEARWRENCH® 12 Pc. 12 Point Metric Indexing Combination Ratcheting Wrench Set

- Locking Pivot Joint Enables 13 Different Positions for Access to Hard-To-Get Places
- Unlock the Pivot Joint for Rapid Piston Pumping Motion
- Surface Drive® on Box End Provides Off-Corner Loading for Better Grip and Reduced Fastener Rounding
- Ratcheting Box End Needs As Little As 5° to Move Fasteners vs. 30° for Standard Wrenches



Cat. No.	UPC No.	Packaging	Product Weight
85488	099575854880	Carded	4.39 lb

Cat. No.	Description	Cat. No.	Description
85418	8mm Indexing Combination Wrench	85444	14mm Indexing Combination Wrench
85439D	9mm Indexing Combination Wrench	85445	15mm Indexing Combination Wrench
85440D	10mm Indexing Combination Wrench	85446	16mm Indexing Combination Wrench
85441D	11mm Indexing Combination Wrench	85447	17mm Indexing Combination Wrench
85442	12mm Indexing Combination Wrench	85448	18mm Indexing Combination Wrench
85443	13mm Indexing Combination Wrench	85449	19mm Indexing Combination Wrench

GEARWRENCH® 8 Pc. 12 Point SAE Indexing Combination Ratcheting Wrench Set

- Locking Pivot Joint Enables 13 Different Positions for Access to Hard-To-Get Places
- Unlock the Pivot Joint for Rapid Piston Pumping Motion
- Surface Drive® on Box End Provides Off-Corner Loading for Better Grip and Reduced Fastener Rounding
- Ratcheting Box End Needs As Little As 5° to Move Fasteners vs. 30° for Standard Wrenches



Cat. No.	UPC No.	Packaging	Product Weight
85498	099575854989	Carded	2.98 lb

Cat. No.	Description	Cat. No.	Description
85450	5/16" Indexing Combination Wrench	85458	9/16" Indexing Combination Wrench
85452	3/8" Indexing Combination Wrench	85460	5/8" Indexing Combination Wrench
85454	7/16" Indexing Combination Wrench	85462	11/16" Indexing Combination Wrench
85456	1/2" Indexing Combination Wrench	85464	3/4" Indexing Combination Wrench

GEARWRENCH® 12 Point SAE Indexing Combination Ratcheting Wrenches

- Locking Pivot Joint Enables 13 Different Positions for Access to Hard-To-Get Places
- Unlock the Pivot Joint for Rapid Piston Pumping Motion
- Surface Drive® on Box End Provides Off-Corner Loading for Better Grip and Reduced Fastener Rounding
- Surface Drive Plus™ on Open End: Stronger Grip, Reduces Fastener Rounding, Up to 25% More Torque
- Ratcheting Box End Needs As Little As 5° to Move Fasteners vs. 30° for Standard Wrenches



Cat. No.	UPC No.	Packaging	Fastener Size	End A Width	End A Thickness	End B Width	End B Thickness	Overall Length	Product Weight
85450	099575854507	Carded	5/16 in	0.709 in	0.197 in	0.535 in	0.127 in	4.949 in	0.13 lb
85452	099575854521	Carded	3/8 in	0.906 in	0.220 in	0.574 in	0.127 in	5.909 in	0.20 lb
85454	099575854545	Carded	7/16 in	0.984 in	0.240 in	0.618 in	0.127 in	6.417 in	0.22 lb
85456	099575854569	Carded	1/2 in	1.102 in	0.303 in	0.685 in	0.171 in	7.217 in	0.32 lb
85458	099575854583	Carded	9/16 in	1.260 in	0.307 in	0.728 in	0.171 in	7.665 in	0.38 lb
85460	099575854606	Carded	5/8 in	1.378 in	0.346 in	0.813 in	0.197 in	8.508 in	0.52 lb
85462	099575854620	Carded	11/16 in	1.496 in	0.370 in	0.844 in	0.197 in	9.016 in	0.62 lb
85464	099575854644	Carded	3/4 in	1.654 in	0.386 in	0.883 in	0.197 in	10.122 in	0.72 lb

GEARWRENCH® 12 Point Metric Indexing Combination Ratcheting Wrenches

- Locking Pivot Joint Enables 13 Different Positions for Access to Hard-To-Get Places
- Unlock the Pivot Joint for Rapid Piston Pumping Motion
- Surface Drive® on Box End Provides Off-Corner Loading for Better Grip and Reduced Fastener Rounding
- Surface Drive Plus™ on Open End: Stronger Grip, Reduces Fastener Rounding, Up to 25% More Torque
- Ratcheting Box End Needs As Little As 5° to Move Fasteners vs. 30° for Standard Wrenches



Cat. No.	UPC No.	Packaging	Fastener Size	End A Width	End A Thickness	End B Width	End B Thickness	Overall Length	Product Weight
85418	099575854187	Carded	8 mm	0.709 in	0.197 in	0.535 in	0.127 in	4.949 in	0.13 lb
85439D	099575854392	Carded	9 mm	0.787 in	0.209 in	0.543 in	0.127 in	5.394 in	0.15 lb
85440D	099575854408	Carded	10 mm	0.906 in	0.220 in	0.574 in	0.127 in	5.909 in	0.19 lb
85441D	099575854415	Carded	11 mm	0.984 in	0.240 in	0.618 in	0.127 in	6.417 in	0.23 lb
85442	099575854422	Carded	12 mm	1.063 in	0.260 in	0.660 in	0.171 in	6.783 in	0.27 lb
85443	099575854439	Carded	13 mm	1.102 in	0.303 in	0.685 in	0.171 in	7.217 in	0.31 lb
85444	099575854446	Carded	14 mm	1.260 in	0.307 in	0.728 in	0.171 in	7.665 in	0.38 lb
85445	099575854453	Carded	15 mm	1.299 in	0.315 in	0.766 in	0.171 in	8.185 in	0.43 lb
85446	099575854460	Carded	16 mm	1.378 in	0.346 in	0.813 in	0.197 in	8.508 in	0.52 lb
85447	099575854477	Carded	17 mm	1.496 in	0.370 in	0.844 in	0.197 in	9.016 in	0.60 lb
85448	099575854484	Carded	18 mm	1.535 in	0.370 in	0.851 in	0.197 in	9.555 in	0.65 lb
85449	099575854491	Carded	19 mm	1.654 in	0.386 in	0.883 in	0.197 in	10.122 in	0.70 lb

GEARWRENCH® 12 Pc. 12 Point Metric Open End Ratcheting Combination Wrench Set

- Allows Ratcheting of Nuts and Bolts Without Removing Wrench From Fastener, Making Jobs Faster and Easier
- Ratcheting Speed with the Access of An Open End Wrench
- 72 Teeth Ratcheting Box End Needs As Little As 5° to Move Fasteners Versus 30° for Standard Box End Wrenches



Cat. No.	UPC No.	Packaging	Product Weight
85597	099575855979	Carded	3.15 lb

Cat. No.	Description	Cat. No.	Description
85508	8mm Ratcheting Open End Combination Wrench	85514D	14mm Ratcheting Open End Combination Wrench
85509	9mm Ratcheting Open End Combination Wrench	85515	15mm Ratcheting Open End Combination Wrench
85510	10mm Ratcheting Open End Combination Wrench	85516	16mm Ratcheting Open End Combination Wrench
85511	11mm Ratcheting Open End Combination Wrench	85517	17mm Ratcheting Open End Combination Wrench
85512D	12mm Ratcheting Open End Combination Wrench	85518	18mm Ratcheting Open End Combination Wrench
85513	13mm Ratcheting Open End Combination Wrench	85519	19mm Ratcheting Open End Combination Wrench

GEARWRENCH® 8 Pc. 12 Point SAE Open End Ratcheting Combination Wrench Set

- Allows Ratcheting of Nuts and Bolts Without Removing Wrench From Fastener, Making Jobs Faster and Easier
- Ratcheting Speed with the Access of An Open End Wrench
- 72 Teeth Ratcheting Box End Needs As Little As 5° to Move Fasteners Versus 30° for Standard Box End Wrenches



Cat. No.	UPC No.	Packaging	Product Weight
85599	099575855993	Carded	2.50 lb

Cat. No.	Description	Cat. No.	Description
85570	5/16" Ratcheting Open End Combination Wrench	85578	9/16" Ratcheting Open End Combination Wrench
85572	3/8" Ratcheting Open End Combination Wrench	85580	5/8" Ratcheting Open End Combination Wrench
85574	7/16" Ratcheting Open End Combination Wrench	85582	11/16" Ratcheting Open End Combination Wrench
85576	1/2" Ratcheting Open End Combination Wrench	85584	3/4" Ratcheting Open End Combination Wrench

GEARWRENCH® 12 Point SAE Open End Ratcheting Combination Wrenches

- Allows Ratcheting of Nuts and Bolts Without Removing Wrench From Fastener, Making Jobs Faster and Easier
- Ratcheting Speed with the Access of An Open End Wrench
- 72 Teeth Ratcheting Box End Needs As Little As 5° to Move Fasteners Versus 30° for Standard Box End Wrenches



Cat. No.	UPC No.	Fastener Size	End A Width	End A Thickness	End B Width	End B Thickness	Overall Length	Product Weight
85570	099575855702	5/16 in	0.658 in	0.197 in	0.625 in	0.256 in	5.508 in	0.12 lb
85572	099575855726	3/8 in	0.822 in	0.220 in	0.750 in	0.287 in	6.256 in	0.17 lb
85574	099575855740	7/16 in	0.905 in	0.240 in	0.811 in	0.303 in	6.508 in	0.19 lb
85576	099575855764	1/2 in	1.069 in	0.303 in	0.930 in	0.339 in	7.008 in	0.25 lb
85578	099575855788	9/16 in	1.152 in	0.307 in	1.020 in	0.354 in	7.504 in	0.31 lb
85580	099575855801	5/8 in	1.316 in	0.346 in	1.130 in	0.390 in	8.201 in	0.43 lb
85582	099575855825	11/16 in	1.399 in	0.370 in	1.201 in	0.406 in	8.878 in	0.49 lb
85584	099575855849	3/4 in	1.563 in	0.386 in	1.278 in	0.441 in	9.764 in	0.58 lb

GEARWRENCH® 12 Point Metric Open End Ratcheting Combination Wrenches

- Allows Ratcheting of Nuts and Bolts Without Removing Wrench From Fastener, Making Jobs Faster and Easier
- Ratcheting Speed with the Access of An Open End Wrench
- 72 Teeth Ratcheting Box End Needs As Little As 5° to Move Fasteners Versus 30° for Standard Box End Wrenches



Cat. No.	UPC No.	Fastener Size	End A Width	End A Thickness	End B Width	End B Thickness	Overall Length	Product Weight
85508	099575855085	8 mm	0.658 in	0.197 in	0.625 in	0.256 in	5.508 in	0.12 lb
85509	099575855092	9 mm	0.741 in	0.209 in	0.689 in	0.272 in	5.882 in	0.13 lb
85510	099575855108	10 mm	0.822 in	0.220 in	0.750 in	0.287 in	6.256 in	0.17 lb
85511	099575855115	11 mm	0.905 in	0.240 in	0.811 in	0.303 in	6.508 in	0.21 lb
85512D	099575855122	12 mm	0.988 in	0.260 in	0.855 in	0.323 in	6.756 in	0.24 lb
85513	099575855139	13 mm	1.069 in	0.303 in	0.930 in	0.339 in	7.008 in	0.26 lb
85514D	099575855146	14 mm	1.152 in	0.307 in	1.020 in	0.354 in	7.504 in	0.31 lb
85515	099575855153	15 mm	1.233 in	0.315 in	1.070 in	0.370 in	7.854 in	0.35 lb
85516	099575855160	16 mm	1.316 in	0.346 in	1.130 in	0.390 in	8.201 in	0.40 lb
85517	099575855177	17 mm	1.399 in	0.370 in	1.201 in	0.406 in	8.878 in	0.49 lb
85518	099575855184	18 mm	1.480 in	0.370 in	1.239 in	0.421 in	9.315 in	0.53 lb
85519	099575855191	19 mm	1.563 in	0.386 in	1.278 in	0.441 in	9.764 in	0.50 lb

GEARWRENCH® 13 Pc. 12 Point SAE QuadBox™ Double Box Ratcheting Wrench Set

- QuadBox™ Design Has 2 Fastener Sizes in Each Box End
- Reversing Levers on Both Sides for Fast, Easy Access
- Save Weight: 4 Sizes in One Wrench!
- Surface Drive® on Box End Provides Off-Corner Loading for Better Grip and Reduced Fastener Rounding

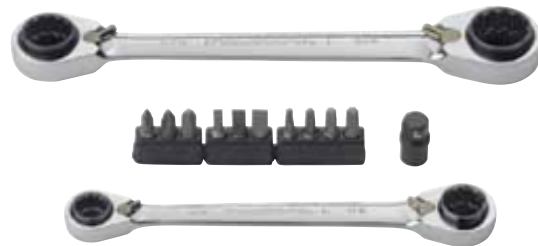

Cat. No.	UPC No.	Packaging	Product Weight
85200	099575852008	Carded	0.85 lb

Cat. No.	Description	Cat. No.	Description	Cat. No.	Description
85201	QuadBox Ratcheting Wrench 5/16", 3/8", 7/16", 1/2"	-	1/4" Bit Holder	-	T-20 Torx® Bit
85202D	QuadBox Ratcheting Wrench 9/16", 5/8", 11/16", 3/4"	-	1/4" Slotted Bit	-	T-25 Torx® Bit
-	#1 Phillips Bit	-	5/32" Slotted Bit	-	T-27 Torx® Bit
-	#2 Phillips Bit	-	7/32" Slotted Bit	-	
-	#3 Phillips Bit	-	T-15 Torx® Bit	-	

GEARWRENCH® 13 Pc. 12 Point Metric QuadBox™ Double Box Ratcheting Wrench Set

- QuadBox™ Design Has 2 Fastener Sizes in Each Box End
- Reversing Levers on Both Sides for Fast, Easy Access
- Save Weight: 4 Sizes in One Wrench!
- Surface Drive® on Box End Provides Off-Corner Loading for Better Grip and Reduced Fastener Rounding



Cat. No.	UPC No.	Packaging	Product Weight
85210D	099575852107	Carded	0.90 lb

Cat. No.	Description	Cat. No.	Description	Cat. No.	Description
85211	QuadBox Ratcheting Wrench 8mm, 10mm, 12mm, 13mm	-	1/4" Bit Holder	-	T-20 Torx® Bit
85212	QuadBox Ratcheting Wrench 16mm, 17mm, 18mm, 19mm	-	1/4" Slotted Bit	-	T-25 Torx® Bit
-	#1 Phillips Bit	-	5/32" Slotted Bit	-	T-27 Torx® Bit
-	#2 Phillips Bit	-	7/32" Slotted Bit	-	
-	#3 Phillips Bit	-	T-15 Torx® Bit	-	

GEARWRENCH® 3 Pc. 12 Point SAE QuadBox™ Double Box Ratcheting Wrench Set

- QuadBox™ Design Has 2 Fastener Sizes in Each Box End
- Reversing Levers on Both Sides for Fast, Easy Access
- Save Weight: 4 Sizes in One Wrench!
- Surface Drive® on Box End Provides Off-Corner Loading for Better Grip and Reduced Fastener Rounding



Cat. No.	UPC No.	Packaging	Product Weight
85204	099575852046	Boxed	2.02 lb

Cat. No.	Description	Cat. No.	Description
85201	QuadBox Ratcheting Wrench 5/16", 3/8", 7/16", 1/2"	85203	QuadBox Ratcheting Wrench 13/16", 7/8", 15/16", 1"
85202D	QuadBox Ratcheting Wrench 9/16", 5/8", 11/16", 3/4"		

GEARWRENCH® 4 Pc. 12 Point Metric QuadBox™ Double Box Ratcheting Wrench Set

- QuadBox™ Design Has 2 Fastener Sizes in Each Box End
- Reversing Levers on Both Sides for Fast, Easy Access
- Save Weight: 4 Sizes in One Wrench!
- Surface Drive® on Box End Provides Off-Corner Loading for Better Grip and Reduced Fastener Rounding



Cat. No.	UPC No.	Packaging	Product Weight
85215	099575852152	Boxed	2.25 lb

Cat. No.	Description	Cat. No.	Description
85211	QuadBox Ratcheting Wrench 8mm, 10mm, 12mm, 13mm	85212	QuadBox Ratcheting Wrench 16mm, 17mm, 18mm, 19mm
85213	QuadBox Ratcheting Wrench 9mm, 11mm, 14mm, 15mm	85214	QuadBox Ratcheting Wrench 20mm, 21mm, 22mm, 24mm

GEARWRENCH® 12 Point SAE QuadBox™ Double Box Ratcheting Wrenches

- QuadBox™ Design Has 2 Fastener Sizes in Each Box End
- Reversing Levers on Both Sides for Fast, Easy Access
- Save Weight: 4 Sizes in One Wrench!
- Surface Drive® on Box End Provides Off-Corner Loading for Better Grip and Reduced Fastener Rounding



Cat. No.	UPC No.	Packaging	End A Fastener Size	End A Width	End A Thickness	End B Fastener Size	End B Width	End B Thickness	Overall Length	Product Weight
85201	099575852015	Carded	5/16 in, 3/8 in	0.780 in	0.470 in	7/16 in, 1/2 in	0.980 in	0.590 in	6.300 in	0.19 lb
85202D	099575852022	Carded	9/16 in, 5/8 in	1.200 in	0.670 in	11/16 in, 3/4 in	1.340 in	0.750 in	8.270 in	0.44 lb
85203	099575852039	Carded	13/16 in, 7/8 in	1.540 in	0.910 in	15/16 in, 1 in	1.790 in	1.100 in	11.420 in	1.04 lb

GEARWRENCH® 12 Point Metric QuadBox™ Double Box Ratcheting Wrenches

- QuadBox™ Design Has 2 Fastener Sizes in Each Box End
- Reversing Levers on Both Sides for Fast, Easy Access
- Save Weight: 4 Sizes in One Wrench!
- Surface Drive® on Box End Provides Off-Corner Loading for Better Grip and Reduced Fastener Rounding



Cat. No.	UPC No.	Packaging	End A Fastener Size	End A Width	End A Thickness	End B Fastener Size	End B Width	End B Thickness	Overall Length	Product Weight
85211	099575852114	Carded	8 mm, 10 mm	0.780 in	0.470 in	12 mm, 13 mm	0.980 in	0.590 in	6.300 in	0.18 lb
85213	099575852138	Carded	9 mm, 11 mm	0.850 in	0.510 in	14 mm, 15 mm	1.130 in	0.630 in	7.090 in	0.26 lb
85212	099575852121	Carded	16 mm, 17 mm	1.270 in	0.710 in	18 mm, 19 mm	1.340 in	0.790 in	9.060 in	0.47 lb
85214	099575852145	Carded	20 mm, 21 mm	1.540 in	0.910 in	22 mm, 24 mm	1.790 in	1.100 in	11.420 in	1.03 lb

GEARWRENCH® SAE QuadBox™ HVAC Ratcheting Wrenches

- Quadbox™ Design Has 2 Fastener Sizes in Each Box End
- Reversing Levers on Both Sides for Fast, Easy Access
- Save Weight: 4 Sizes in One Wrench!
- HVAC Square and Hex Tool
- Surface Drive® on Box End Provides Off-Corner Loading for Better Grip and Reduced Fastener Rounding



Cat. No.	UPC No.	Packaging	End A Drive Type	End B Drive Type	End A Fastener Size	End A Width	End A Thickness	End B Fastener Size	End B Width	End B Thickness	Overall Length	Product Weight
85220D	099575852206	Carded	Square	Square	1/4 in, 3/16 in	0.780 in	0.496 in	3/8 in, 5/16 in	0.850 in	0.488 in	5.512 in	0.19 lb
85221	099575852213	Carded	Square	6 Point	1/4 in, 3/16 in	0.780 in	0.496 in	9/16 in, 1/2 in	1.035 in	0.598 in	6.890 in	0.27 lb

GEARWRENCH® 6 Pc. 12 Point Metric Double Box Ratcheting Wrench Set

- Save Weight: 2 Sizes in One Wrench!
- Surface Drive® on Box End Provides Off-Corner Loading for Better Grip and Reduced Fastener Rounding



Cat. No.	UPC No.	Packaging	Product Weight
9260	082171092602	Carded	1.60 lb

Cat. No.	Description	Cat. No.	Description
9210D	8mm x 9mm Double Box Ratcheting Wrench	9213	14mm x 15mm Double Box Ratcheting Wrench
9211D	10mm x 11mm Double Box Ratcheting Wrench	9214	16mm x 18mm Double Box Ratcheting Wrench
9212D	12mm x 13mm Double Box Ratcheting Wrench	9215D	17mm x 19mm Double Box Ratcheting Wrench

GEARWRENCH® 4 Pc. 12 Point SAE Double Box Ratcheting Wrench Set

- Save Weight: 2 Sizes in One Wrench!
- Surface Drive® on Box End Provides Off-Corner Loading for Better Grip and Reduced Fastener Rounding



Cat. No.	UPC No.	Packaging	Product Weight
9240D	082171092404	Carded	1.13 lb

Cat. No.	Description	Cat. No.	Description
9201D	5/16" x 3/8" Double Box Ratcheting Wrench	9203	9/16" x 5/8" Double Box Ratcheting Wrench
9202D	7/16" x 1/2" Double Box Ratcheting Wrench	9204D	11/16" x 3/4" Double Box Ratcheting Wrench

GEARWRENCH® 12 Point SAE Double Box Ratcheting Wrenches

- Save Weight: 2 Sizes in One Wrench!
- Surface Drive® on Box End Provides Off-Corner Loading for Better Grip and Reduced Fastener Rounding



Cat. No.	UPC No.	Packaging	End A Fastener Size	End A Width	End A Thickness	End B Fastener Size	End B Width	End B Thickness	Overall Length	Product Weight
9201D	082171092015	Carded	5/16 in	0.665 in	0.272 in	3/8 in	0.705 in	0.272 in	5.118 in	0.13 lb
9202D	082171092022	Carded	7/16 in	0.854 in	0.323 in	1/2 in	0.984 in	0.339 in	6.299 in	0.16 lb
9203	082171092039	Carded	9/16 in	1.035 in	0.370 in	5/8 in	1.201 in	0.406 in	7.480 in	0.31 lb
9204D	082171092046	Carded	11/16 in	1.272 in	0.421 in	3/4 in	1.339 in	0.441 in	9.055 in	0.45 lb

GEARWRENCH® 12 Point Metric Double Box Ratcheting Wrenches

- Save Weight: 2 Sizes in One Wrench!
- Surface Drive® on Box End Provides Off-Corner Loading for Better Grip and Reduced Fastener Rounding



Cat. No.	UPC No.	Packaging	End A Fastener Size	End A Width	End A Thickness	End B Fastener Size	End B Width	End B Thickness	Overall Length	Product Weight
9210D	082171092107	Carded	8 mm	0.665 in	0.272 in	9 mm	0.705 in	0.272 in	5.118 in	0.11 lb
9211D	082171092114	Carded	10 mm	0.780 in	0.303 in	11 mm	0.854 in	0.323 in	5.906 in	0.14 lb
9212D	082171092121	Carded	12 mm	0.906 in	0.339 in	13 mm	0.984 in	0.339 in	6.693 in	0.22 lb
9213	082171092138	Carded	14 mm	1.035 in	0.370 in	15 mm	1.130 in	0.390 in	7.480 in	0.27 lb
9214	082171092145	Carded	16 mm	1.201 in	0.406 in	18 mm	1.307 in	0.441 in	8.268 in	0.42 lb
9215D	082171092152	Carded	17 mm	1.272 in	0.421 in	19 mm	1.339 in	0.441 in	9.055 in	0.46 lb

GEARWRENCH® 5 Pc. 12 Point Metric Half Moon Reversible Double Box Ratcheting Wrench Set

- Slim Half Moon Design Allows for Easy Access Around Obstructions
- Surface Drive® on Box End Provides Off-Corner Loading for Better Grip and Reduced Fastener Rounding



Cat. No.	UPC No.	Packaging	Product Weight
9850	082171098505	Carded	2.61 lb

Cat. No.	Description	Cat. No.	Description
9851D	10mm x 12mm Half-Moon Double Box Ratcheting Wrench	9854	15mm x 17mm Half-Moon Double Box Ratcheting Wrench
9852D	11mm x 13mm Half-Moon Double Box Ratcheting Wrench	9855D	19mm x 22mm Half-Moon Double Box Ratcheting Wrench
9853	14mm x 16mm Half-Moon Double Box Ratcheting Wrench		

GEARWRENCH® 4 Pc. 12 Point SAE Half Moon Reversible Double Box Ratcheting Wrench Set

- Slim Half Moon Design Allows for Easy Access Around Obstructions
- Surface Drive® on Box End Provides Off-Corner Loading for Better Grip and Reduced Fastener Rounding



Cat. No.	UPC No.	Packaging	Product Weight
9840D	082171098406	Carded	2.33 lb

Cat. No.	Description	Cat. No.	Description
9841D	3/8" x 7/16" Half-Moon Double Box Ratcheting Wrench	9843D	5/8" x 11/16" Half-Moon Double Box Ratcheting Wrench
9842	1/2" x 9/16" Half-Moon Double Box Ratcheting Wrench	9844	3/4" x 7/8" Half-Moon Double Box Ratcheting Wrench

GEARWRENCH® 12 Point SAE Half Moon Reversible Double Box Ratcheting Wrenches

- Slim Half Moon Design Allows for Easy Access Around Obstructions
- Surface Drive® on Box End Provides Off-Corner Loading for Better Grip and Reduced Fastener Rounding



Cat. No.	UPC No.	Packaging	End A Fastener Size	End A Width	End A Thickness	End B Fastener Size	End B Width	End B Thickness	Overall Length	Product Weight
9841D	082171098413	Carded	3/8 in	0.780 in	0.303 in	7/16 in	0.906 in	0.323 in	5.157 in	0.15 lb
9842	082171098420	Carded	1/2 in	0.984 in	0.339 in	9/16 in	1.035 in	0.370 in	6.22 in	0.45 lb
9843D	082171098437	Carded	5/8 in	1.201 in	0.406 in	11/16 in	1.307 in	0.421 in	7.913 in	0.50 lb
9844	082171098444	Carded	3/4 in	1.339 in	0.441 in	7/8 in	1.535 in	0.512 in	9.094 in	0.19 lb

GEARWRENCH® 12 Point Metric Half Moon Reversible Double Box Ratcheting Wrenches

- Slim Half Moon Design Allows for Easy Access Around Obstructions
- Surface Drive® on Box End Provides Off-Corner Loading for Better Grip and Reduced Fastener Rounding



Cat. No.	UPC No.	Packaging	End A Fastener Size	End A Width	End A Thickness	End B Fastener Size	End B Width	End B Thickness	Overall Length	Product Weight
9851D	082171098512	Carded	10 mm	0.780 in	0.303 in	12 mm	0.906 in	0.339 in	5.157 in	0.50 lb
9852D	082171098529	Carded	11 mm	0.854 in	0.323 in	13 mm	0.984 in	0.339 in	5.787 in	0.25 lb
9853	082171098536	Carded	14 mm	1.035 in	0.370 in	16 mm	1.272 in	0.406 in	6.654 in	1.10 lb
9854	082171098543	Carded	15 mm	1.201 in	0.390 in	17 mm	1.307 in	0.421 in	7.913 in	1.30 lb
9855D	082171098550	Carded	19 mm	1.339 in	0.441 in	22 mm	1.535 in	0.512 in	9.094 in	1.32 lb

GEARWRENCH® 5 Pc. 12 Point Metric S-Shape Reversible Double Box Ratcheting Wrench Set

- Slim S-Shape Design Allows for Easy Access Around Obstructions
- Surface Drive® on Box End Provides Off-Corner Loading for Better Grip and Reduced Fastener Rounding



Cat. No.	UPC No.	Packaging	Product Weight
85299	082171852992	Carded	2.73 lb

Cat. No.	Description	Cat. No.	Description
85222	10mm x 12mm Reversible "S-shaped" Double Box Ratcheting Wrench	85232	15mm x 17mm Reversible "S-shaped" Double Box Ratcheting Wrench
85224	11mm x 13mm Reversible "S-shaped" Double Box Ratcheting Wrench	85241D	19mm x 22mm Reversible "S-shaped" Double Box Ratcheting Wrench
85230	14mm x 16mm Reversible "S-shaped" Double Box Ratcheting Wrench		

GEARWRENCH® 4 Pc. 12 Point SAE S-Shape Reversible Double Box Ratcheting Wrench Set

- Slim S-Shape Design Allows for Easy Access Around Obstructions
- Surface Drive® on Box End Provides Off-Corner Loading for Better Grip and Reduced Fastener Rounding



Cat. No.	UPC No.	Packaging	Product Weight
85399	082171853999	Carded	2.40 lb

Cat. No.	Description	Cat. No.	Description
85326	3/8" x 7/16" Reversible "S-shaped" Double Box Ratcheting Wrench	85342	5/8" x 11/16" Reversible "S-shaped" Double Box Ratcheting Wrench
85334	1/2" x 9/16" Reversible "S-shaped" Double Box Ratcheting Wrench	85352	3/4" x 7/8" Reversible "S-shaped" Double Box Ratcheting Wrench

GEARWRENCH® 12 Point SAE S-Shape Reversible Double Box Ratcheting Wrenches

- Slim S-Shape Design Allows for Easy Access Around Obstructions
- Surface Drive® on Box End Provides Off-Corner Loading for Better Grip and Reduced Fastener Rounding



Cat. No.	UPC No.	Packaging	End A Fastener Size	End A Width	End A Thickness	End B Fastener Size	End B Width	End B Thickness	Overall Length	Product Weight
85326	082171853265	Carded	3/8 in	1.535 in	0.512 in	7/16 in	1.339 in	0.441 in	8.811 in	0.18 lb
85334	082171853340	Carded	1/2 in	0.984 in	0.370 in	9/16 in	1.035 in	0.339 in	6.268 in	0.29 lb
85342	082171853425	Carded	5/8 in	1.307 in	0.421 in	11/16 in	1.201 in	0.406 in	8.114 in	0.56 lb
85352	082171853524	Carded	3/4 in	1.535 in	0.512 in	7/8 in	1.339 in	0.441 in	8.811 in	0.81 lb

GEARWRENCH® 12 Point Metric S-Shape Reversible Double Box Ratcheting Wrenches

- Slim S-Shape Design Allows for Easy Access Around Obstructions
- Surface Drive® on Box End Provides Off-Corner Loading for Better Grip and Reduced Fastener Rounding



Cat. No.	UPC No.	Packaging	End A Fastener Size	End A Width	End A Thickness	End B Fastener Size	End B Width	End B Thickness	Overall Length	Product Weight
85222	082171852220	Carded	10 mm	0.906 in	0.339 in	12 mm	0.780 in	0.303 in	5.217 in	0.18 lb
85224	082171852244	Carded	11 mm	0.984 in	0.339 in	13 mm	0.854 in	0.323 in	5.650 in	0.23 lb
85230	082171852305	Carded	14 mm	1.272 in	0.406 in	16 mm	1.035 in	0.370 in	6.906 in	0.40 lb
85232	082171852329	Carded	15 mm	1.307 in	0.421 in	17 mm	1.201 in	0.390 in	8.114 in	0.55 lb
85241D	082171852411	Carded	19 mm	1.535 in	0.512 in	22 mm	1.339 in	0.441 in	8.811 in	1.00 lb

GEARWRENCH® 4 Pc. E-Torx® Double Box Ratcheting Wrench Set

- E-Torx® Design
- Save Weight: 2 Sizes in One Wrench!
- Surface Drive® on Box End Provides Off-Corner Loading for Better Grip and Reduced Fastener Rounding



Cat. No.	UPC No.	Packaging	Product Weight
9224D	082171092244	Carded	1.00 lb

Cat. No.	Description	Cat. No.	Description
9220D	E6 x E8 Torx Double Box Ratcheting Wrench	9222	E14 x E18 Torx Double Box Ratcheting Wrench
9221	E10 x E12 Torx Double Box Ratcheting Wrench	9223	E20 x E24 Torx Double Box Ratcheting Wrench

GEARWRENCH® E-Torx® Double Box Ratcheting Wrenches

- E-Torx® Design
- Save Weight: 2 Sizes in One Wrench!
- Surface Drive® on Box End Provides Off-Corner Loading for Better Grip and Reduced Fastener Rounding



Cat. No.	UPC No.	Packaging	End A Fastener Size	End A Width	End A Thickness	End B Fastener Size	End B Width	End B Thickness	Overall Length	Product Weight
9220D	082171092206	Carded	E6	0.630 in	0.689 in	E8	0.256 in	0.272 in	5.118 in	0.06 lb
9221	082171092213	Carded	E10	0.748 in	0.811 in	E12	0.287 in	0.303 in	5.906 in	0.11 lb
9222	082171092220	Carded	E14	0.849 in	1.130 in	E18	0.354 in	0.390 in	7.480 in	0.26 lb
9223	082171092237	Carded	E20	1.201 in	1.280 in	E24	0.406 in	0.441 in	9.055 in	0.36 lb

GEARWRENCH® 2 Pc. Access Bit Adapter Set

- Converts a 1/2" Ratcheting Wrench to a Ratcheting Bit Driver
- For Use with 1/4" and 5/16" Bits



Cat. No.	UPC No.	Packaging	Product Weight
9535D	082171095351	Carded	0.18 lb

GEARWRENCH® 3 Pc. SAE Drive Adapter Set

- Socket Adapter Converts a 3/8" Ratcheting Wrench to a 1/4" Drive Tang
- Socket Adapter Converts a 1/2" Ratcheting Wrench to a 3/8" Drive Tang
- Socket Adapter Converts a 3/4" Ratcheting Wrench to a 1/2" Drive Tang



SAE

Cat. No.	UPC No.	Packaging	Product Weight
9231D	082171092312	Carded	0.25 lb

Cat. No.	Description	Cat. No.	Description
9217	Wrench Drive Adapter 3/8" to 1/4" Drive Square	9219	Wrench Drive Adapter 3/4" to 1/2" Drive Square
9218D	Wrench Drive Adapter 1/2" to 3/8" Drive Square		

GEARWRENCH® 3 Pc. Metric Drive Adapter Set

- Socket Adapter Converts a 10mm Ratcheting Wrench to a 1/4" Drive Tang
- Socket Adapter Converts a 13mm Ratcheting Wrench to a 3/8" Drive Tang
- Socket Adapter Converts a 19mm Ratcheting Wrench to a 1/2" Drive Tang



mm

Cat. No.	UPC No.	Packaging	Product Weight
9230D	082171092305	Carded	0.25 lb

Cat. No.	Description	Cat. No.	Description
9207	Wrench Drive Adapter 10mm to 1/4" Drive Square	9209D	Wrench Drive Adapter 19mm to 1/2" Drive Square
9208D	Wrench Drive Adapter 13mm to 3/8" Drive Square		

GEARWRENCH® 37 Pc. Access Bit Set with 1/2" Reversible Ratcheting Wrench



Cat. No.	UPC No.	Packaging	Product Weight
9537N	082171095375	Carded	0.85 lb

Cat. No.	Description	Cat. No.	Description	Cat. No.	Description	Cat. No.	Description
9528N	1/2" Reversible Combination Ratcheting Wrench	-	7mm Hex Bit	-	1/4" Hex Bit	-	T-20 Torx® Bit
-	Socket Adapter	-	8mm Hex Bit	-	5/16" Hex Bit	-	T-25 Torx® Bit
-	1/4" Bit Holder	-	10mm Hex Bit	-	3/8" Hex Bit	-	T-27 Torx® Bit
-	5/16" Bit Holder	-	3/32" Hex Bit	-	#1 Phillips Bit	-	T-30 Torx® Bit
-	2mm Hex Bit	-	7/64" Hex Bit	-	#2 Phillips Bit	-	T-40 Torx® Bit
-	2.5mm Hex Bit	-	1/8" Hex Bit	-	#3 Phillips Bit	-	T-45 Torx® Bit
-	3mm Hex Bit	-	9/64" Hex Bit	-	1/4" Slotted Bit	-	T-50 Torx® Bit
-	4mm Hex Bit	-	5/32" Hex Bit	-	9/32" Slotted Bit		
-	5mm Hex Bit	-	3/16" Hex Bit	-	T-10 Torx® Bit		
-	6mm Hex Bit	-	7/32" Hex Bit	-	T-15 Torx® Bit		

GEARWRENCH 12 Pc. 12 Point Metric XL X-Beam™ Combination Wrench Set

- Patented, Award Winning Design
- One Piece Forged Beam Design - No Metal Twisting or Weak Spots
- X-Beam™ Design Has Over 500% More Surface Area, Enabling More Force and Less Hand Fatigue



Cat. No.	UPC No.	Packaging	Product Weight
81912	099575819124	Blow Mold Tray	6.60 lb

Cat. No.	Description	Cat. No.	Description
81698	8mm XL X-Beam™ Combination Wrench	81706	14mm XL X-Beam™ Combination Wrench
81699	9mm XL X-Beam™ Combination Wrench	81707	15mm XL X-Beam™ Combination Wrench
81700	10mm XL X-Beam™ Combination Wrench	81709	16mm XL X-Beam™ Combination Wrench
81701	11mm XL X-Beam™ Combination Wrench	81710	17mm XL X-Beam™ Combination Wrench
81703	12mm XL X-Beam™ Combination Wrench	81711	18mm XL X-Beam™ Combination Wrench
81705	13mm XL X-Beam™ Combination Wrench	81713	19mm XL X-Beam™ Combination Wrench

GEARWRENCH 9 Pc. 12 Point SAE XL X-Beam™ Combination Wrench Set

- Patented, Award Winning Design
- One Piece Forged Beam Design - No Metal Twisting or Weak Spots
- X-Beam™ Design Has Over 500% More Surface Area, Enabling More Force and Less Hand Fatigue



Cat. No.	UPC No.	Packaging	Product Weight
81913	099575819131	Blow Mold Tray	3.52 lb

Cat. No.	Description	Cat. No.	Description
81714	5/16" XL X-Beam™ Combination Wrench	81721	9/16" XL X-Beam™ Combination Wrench
81715	11/32" XL X-Beam™ Combination Wrench	81722	5/8" XL X-Beam™ Combination Wrench
81717	3/8" XL X-Beam™ Combination Wrench	81723	11/16" XL X-Beam™ Combination Wrench
81718	7/16" XL X-Beam™ Combination Wrench	81725	3/4" XL X-Beam™ Combination Wrench
81719	1/2" XL X-Beam™ Combination Wrench		



GEARWRENCH® 12 Point SAE XL X-Beam™ Combination Wrenches

- Large Size Stamp on Open End
- Offset Box End for Better Access
- Bright, Full Polish Chrome Finish
- Made of Premium Alloy Steel
- Surface Drive Plus™ on Open End: Stronger Grip, Reduces Fastener Rounding, Up to 25% More Torque
- Surface Drive® on Box End Provides Off-Corner Loading for Better Grip and Reduced Fastener Rounding



Cat. No.	UPC No.	Packaging	Fastener Size	End A Width	End A Thickness	End B Width	End B Thickness	Overall Length	Product Weight
81714	099575817144	Carded	5/16 in	0.709 in	0.197 in	0.524 in	0.228 in	5.790 in	0.10 lb
81715	099575817151	Carded	11/32 in	0.787 in	0.205 in	0.571 in	0.256 in	6.220 in	0.18 lb
81717	099575817175	Carded	3/8 in	0.955 in	0.224 in	0.622 in	0.283 in	6.540 in	0.21 lb
81718	099575817182	Carded	7/16 in	0.984 in	0.248 in	0.673 in	0.307 in	7.280 in	0.26 lb
81719	099575817199	Carded	1/2 in	1.102 in	0.276 in	0.768 in	0.346 in	8.110 in	0.30 lb
81721	099575817212	Carded	9/16 in	1.260 in	0.295 in	0.835 in	0.378 in	8.720 in	0.41 lb
81722	099575817229	Carded	5/8 in	1.378 in	0.315 in	0.929 in	0.425 in	9.510 in	0.53 lb
81723	099575817236	Carded	11/16 in	1.496 in	0.354 in	1.004 in	0.445 in	10.220 in	0.62 lb
81725	099575817250	Carded	3/4 in	1.654 in	0.374 in	1.087 in	0.488 in	10.960 in	0.79 lb

GEARWRENCH® 12 Point Metric XL X-Beam™ Combination Wrenches

- Large Size Stamp on Open End
- Offset Box End for Better Access
- Bright, Full Polish Chrome Finish
- Made of Premium Alloy Steel
- Surface Drive Plus™ on Open End: Stronger Grip, Reduces Fastener Rounding, Up to 25% More Torque
- Surface Drive® on Box End Provides Off-Corner Loading for Better Grip and Reduced Fastener Rounding



Cat. No.	UPC No.	Packaging	Fastener Size	End A Width	End A Thickness	End B Width	End B Thickness	Overall Length	Product Weight
81698	099575816987	Carded	8 mm	0.709 in	0.197 in	0.524 in	0.228 in	5.790 in	0.10 lb
81699	099575816994	Carded	9 mm	0.787 in	0.205 in	0.571 in	0.256 in	6.220 in	0.18 lb
81700	099575817007	Carded	10 mm	0.906 in	0.224 in	0.622 in	0.283 in	6.540 in	0.21 lb
81701	099575817014	Carded	11 mm	0.984 in	0.248 in	0.673 in	0.307 in	7.280 in	0.26 lb
81703	099575817038	Carded	12 mm	1.063 in	0.264 in	0.717 in	0.339 in	7.720 in	0.31 lb
81705	099575817052	Carded	13 mm	1.102 in	0.276 in	0.768 in	0.346 in	8.110 in	0.31 lb
81706	099575817069	Carded	14 mm	1.260 in	0.295 in	0.835 in	0.378 in	8.720 in	0.41 lb
81707	099575817076	Carded	15 mm	1.299 in	0.315 in	0.878 in	0.402 in	9.130 in	0.47 lb
81709	099575817090	Carded	16 mm	1.378 in	0.315 in	0.929 in	0.425 in	9.510 in	0.53 lb
81710	099575817106	Carded	17 mm	1.496 in	0.354 in	1.004 in	0.445 in	10.220 in	0.62 lb
81711	099575817113	Carded	18 mm	1.516 in	0.354 in	1.035 in	0.465 in	10.590 in	0.69 lb
81713	099575817137	Carded	19 mm	1.654 in	0.374 in	1.087 in	0.488 in	10.960 in	0.79 lb

GEARWRENCH® 44 Pc. 12 Point SAE/Metric Long Pattern Combination Wrench Set

- Long Pattern Length
- Offset Box End for Increased Access
- Surface Drive Plus™ on Open End: Stronger Grip, Reduces Fastener Rounding, Up to 25% More Torque

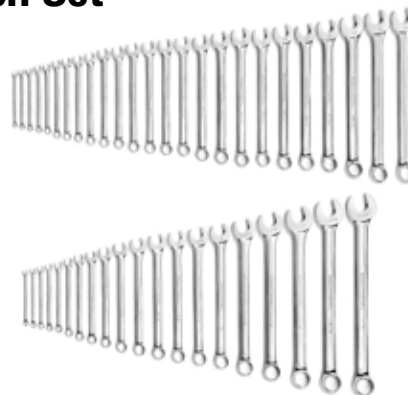

Cat. No.	UPC No.	Packaging	Product Weight
81919	099575819193	Boxed	35.33 lb

Cat. No.	Description	Cat. No.	Description
81650	1/4" Long Pattern Combination Wrench	81666	9mm Long Pattern Combination Wrench
81652D	5/16" Long Pattern Combination Wrench	81667	10mm Long Pattern Combination Wrench
81653	11/32" Long Pattern Combination Wrench	81668	11mm Long Pattern Combination Wrench
81654	3/8" Long Pattern Combination Wrench	81669	12mm Long Pattern Combination Wrench
81655	7/16" Long Pattern Combination Wrench	81670	13mm Long Pattern Combination Wrench
81656	1/2" Long Pattern Combination Wrench	81671	14mm Long Pattern Combination Wrench
81657	9/16" Long Pattern Combination Wrench	81672	15mm Long Pattern Combination Wrench
81658	5/8" Long Pattern Combination Wrench	81673	16mm Long Pattern Combination Wrench
81659	11/16" Long Pattern Combination Wrench	81674	17mm Long Pattern Combination Wrench
81660	3/4" Long Pattern Combination Wrench	81675	18mm Long Pattern Combination Wrench
81661	13/16" Long Pattern Combination Wrench	81676	19mm Long Pattern Combination Wrench
81662	7/8" Long Pattern Combination Wrench	81677	20mm Long Pattern Combination Wrench
81663	15/16" Long Pattern Combination Wrench	81678	21mm Long Pattern Combination Wrench
81664	1" Long Pattern Combination Wrench	81679	22mm Long Pattern Combination Wrench
81733	1-1/16" Long Pattern Combination Wrench	81741	23mm Long Pattern Combination Wrench
81734	1-1/8" Long Pattern Combination Wrench	81742	24mm Long Pattern Combination Wrench
81735	1-1/4" Long Pattern Combination Wrench	81751	25mm Long Pattern Combination Wrench
81749	1-5/16" Full Polish Combination Wrench	81752	26mm Long Pattern Combination Wrench
81750	1-1/2" Full Polish Combination Wrench	81743	27mm Long Pattern Combination Wrench
81736	6mm Long Pattern Combination Wrench	81753	28mm Long Pattern Combination Wrench
81737	7mm Long Pattern Combination Wrench	81744	30mm Long Pattern Combination Wrench
81665	8mm Long Pattern Combination Wrench	81745D	32mm Long Pattern Combination Wrench

GEARWRENCH® 24 Pc. 12 Point SAE/Metric Long Pattern Combination Wrench Set

- Long Pattern Length
- Offset Box End for Increased Access
- Surface Drive Plus™ on Open End: Stronger Grip, Reduces Fastener Rounding, Up to 25% More Torque



Cat. No.	UPC No.	Packaging	Product Weight
81900	099575819001	Blow Mold Tray	12.35 lb

Cat. No.	Description	Cat. No.	Description
81656	1/2" Long Pattern Combination Wrench	81668	11mm Long Pattern Combination Wrench
81657	9/16" Long Pattern Combination Wrench	81669	12mm Long Pattern Combination Wrench
81658	5/8" Long Pattern Combination Wrench	81670	13mm Long Pattern Combination Wrench
81659	11/16" Long Pattern Combination Wrench	81671	14mm Long Pattern Combination Wrench
81660	3/4" Long Pattern Combination Wrench	81672	15mm Long Pattern Combination Wrench
81661	13/16" Long Pattern Combination Wrench	81673	16mm Long Pattern Combination Wrench
81662	7/8" Long Pattern Combination Wrench	81674	17mm Long Pattern Combination Wrench
81663	15/16" Long Pattern Combination Wrench	81675	18mm Long Pattern Combination Wrench
81664	1" Long Pattern Combination Wrench	81676	19mm Long Pattern Combination Wrench
81665	8mm Long Pattern Combination Wrench	81677	20mm Long Pattern Combination Wrench
81666	9mm Long Pattern Combination Wrench	81678	21mm Long Pattern Combination Wrench
81667	10mm Long Pattern Combination Wrench	81679	22mm Long Pattern Combination Wrench

GEARWRENCH® 15 Pc. 12 Point SAE Long Pattern Combination Wrench Set

- Long Pattern Length
- Offset Box End for Increased Access
- Surface Drive Plus™ on Open End: Stronger Grip, Reduces Fastener Rounding, Up to 25% More Torque



Cat. No.	UPC No.	Packaging	Product Weight
81901	099575819018	V Rack	6.05 lb

Cat. No.	Description	Cat. No.	Description
81650	1/4" Long Pattern Combination Wrench	81658	5/8" Long Pattern Combination Wrench
81651D	9/32" Long Pattern Combination Wrench	81659	11/16" Long Pattern Combination Wrench
81652D	5/16" Long Pattern Combination Wrench	81660	3/4" Long Pattern Combination Wrench
81653	11/32" Long Pattern Combination Wrench	81661	13/16" Long Pattern Combination Wrench
81654	3/8" Long Pattern Combination Wrench	81662	7/8" Long Pattern Combination Wrench
81655	7/16" Long Pattern Combination Wrench	81663	15/16" Long Pattern Combination Wrench
81656	1/2" Long Pattern Combination Wrench	81664	1" Long Pattern Combination Wrench
81657	9/16" Long Pattern Combination Wrench		

GEARWRENCH® 18 Pc. 12 Point SAE Long Pattern Combination Wrench Set with Wrench Roll

- Long Pattern Length
- Offset Box End for Increased Access
- Surface Drive Plus™ on Open End: Stronger Grip, Reduces Fastener Rounding, Up to 25% More Torque



Cat. No.	UPC No.	Packaging	Product Weight
81917	099575819179	Boxed	12.40 lb

Cat. No.	Description	Cat. No.	Description
81650	1/4" Long Pattern Combination Wrench	81659	11/16" Long Pattern Combination Wrench
81651D	9/32" Long Pattern Combination Wrench	81660	3/4" Long Pattern Combination Wrench
81652D	5/16" Long Pattern Combination Wrench	81661	13/16" Long Pattern Combination Wrench
81653	11/32" Long Pattern Combination Wrench	81662	7/8" Long Pattern Combination Wrench
81654	3/8" Long Pattern Combination Wrench	81663	15/16" Long Pattern Combination Wrench
81655	7/16" Long Pattern Combination Wrench	81664	1" Long Pattern Combination Wrench
81656	1/2" Long Pattern Combination Wrench	81733	1-1/16" Long Pattern Combination Wrench
81657	9/16" Long Pattern Combination Wrench	81734	1-1/8" Long Pattern Combination Wrench
81658	5/8" Long Pattern Combination Wrench	81735	1-1/4" Long Pattern Combination Wrench

GEARWRENCH® 15 Pc. 12 Point SAE Long Pattern Combination Wrench Set with Wrench Roll

- Long Pattern Length
- Offset Box End for Increased Access
- Surface Drive Plus™ on Open End: Stronger Grip, Reduces Fastener Rounding, Up to 25% More Torque



Cat. No.	UPC No.	Packaging	Product Weight
81918	099575819186	Boxed	12.83 lb

Cat. No.	Description	Cat. No.	Description
81652D	5/16" Long Pattern Combination Wrench	81661	13/16" Long Pattern Combination Wrench
81654	3/8" Long Pattern Combination Wrench	81662	7/8" Long Pattern Combination Wrench
81655	7/16" Long Pattern Combination Wrench	81663	15/16" Long Pattern Combination Wrench
81656	1/2" Long Pattern Combination Wrench	81664	1" Long Pattern Combination Wrench
81657	9/16" Long Pattern Combination Wrench	81733	1-1/16" Long Pattern Combination Wrench
81658	5/8" Long Pattern Combination Wrench	81734	1-1/8" Long Pattern Combination Wrench
81659	11/16" Long Pattern Combination Wrench	81735	1-1/4" Long Pattern Combination Wrench
81660	3/4" Long Pattern Combination Wrench		

GEARWRENCH® 15 Pc. 12 Point Metric Long Pattern Combination Wrench Set

- Long Pattern Length
- Offset Box End for Increased Access
- Surface Drive Plus™ on Open End: Stronger Grip, Reduces Fastener Rounding, Up to 25% More Torque



Cat. No.	UPC No.	Packaging	Product Weight
81902	099575819025	V Rack	9.55 lb

Cat. No.	Description	Cat. No.	Description
81665	8mm Long Pattern Combination Wrench	81673	16mm Long Pattern Combination Wrench
81666	9mm Long Pattern Combination Wrench	81674	17mm Long Pattern Combination Wrench
81667	10mm Long Pattern Combination Wrench	81675	18mm Long Pattern Combination Wrench
81668	11mm Long Pattern Combination Wrench	81676	19mm Long Pattern Combination Wrench
81669	12mm Long Pattern Combination Wrench	81677	20mm Long Pattern Combination Wrench
81670	13mm Long Pattern Combination Wrench	81678	21mm Long Pattern Combination Wrench
81671	14mm Long Pattern Combination Wrench	81679	22mm Long Pattern Combination Wrench
81672	15mm Long Pattern Combination Wrench		

GEARWRENCH® 22 Pc. 12 Point Metric Long Pattern Combination Wrench Set with Wrench Roll

- Long Pattern Length
- Offset Box End for Increased Access
- Surface Drive Plus™ on Open End: Stronger Grip, Reduces Fastener Rounding, Up to 25% More Torque



Cat. No.	UPC No.	Packaging	Product Weight
81916	099575819162	Boxed	13.90 lb

Cat. No.	Description	Cat. No.	Description
81736	6mm Long Pattern Combination Wrench	81674	17mm Long Pattern Combination Wrench
81737	7mm Long Pattern Combination Wrench	81675	18mm Long Pattern Combination Wrench
81665	8mm Long Pattern Combination Wrench	81676	19mm Long Pattern Combination Wrench
81666	9mm Long Pattern Combination Wrench	81677	20mm Long Pattern Combination Wrench
81667	10mm Long Pattern Combination Wrench	81678	21mm Long Pattern Combination Wrench
81668	11mm Long Pattern Combination Wrench	81679	22mm Long Pattern Combination Wrench
81669	12mm Long Pattern Combination Wrench	81741	23mm Long Pattern Combination Wrench
81670	13mm Long Pattern Combination Wrench	81742	24mm Long Pattern Combination Wrench
81671	14mm Long Pattern Combination Wrench	81743	27mm Long Pattern Combination Wrench
81672	15mm Long Pattern Combination Wrench	81744	30mm Long Pattern Combination Wrench
81673	16mm Long Pattern Combination Wrench	81745D	32mm Long Pattern Combination Wrench

GEARWRENCH® 18 Pc. 12 Point Metric Long Pattern Combination Wrench Set with Wrench Roll

- Long Pattern Length
- Offset Box End for Increased Access
- Surface Drive Plus™ on Open End: Stronger Grip, Reduces Fastener Rounding, Up to 25% More Torque



Cat. No.	UPC No.	Packaging	Product Weight
81920	099575819209	Boxed	7.82 lb

Cat. No.	Description	Cat. No.	Description
81737	7mm Long Pattern Combination Wrench	81673	16mm Long Pattern Combination Wrench
81665	8mm Long Pattern Combination Wrench	81674	17mm Long Pattern Combination Wrench
81666	9mm Long Pattern Combination Wrench	81675	18mm Long Pattern Combination Wrench
81667	10mm Long Pattern Combination Wrench	81676	19mm Long Pattern Combination Wrench
81668	11mm Long Pattern Combination Wrench	81677	20mm Long Pattern Combination Wrench
81669	12mm Long Pattern Combination Wrench	81678	21mm Long Pattern Combination Wrench
81670	13mm Long Pattern Combination Wrench	81679	22mm Long Pattern Combination Wrench
81671	14mm Long Pattern Combination Wrench	81741	23mm Long Pattern Combination Wrench
81672	15mm Long Pattern Combination Wrench	81742	24mm Long Pattern Combination Wrench

GEARWRENCH® 5 Pc. 12 Point SAE Large Long Pattern Combination Wrench Set

- Long Pattern Length
- Offset Box End for Increased Access
- Surface Drive Plus™ on Open End: Stronger Grip, Reduces Fastener Rounding, Up to 25% More Torque



Cat. No.	UPC No.	Packaging	Product Weight
81921	099575819216	Boxed	9.94 lb

Cat. No.	Description	Cat. No.	Description
81733	1-1/16" Long Pattern Combination Wrench	81749	1-5/16" Full Polish Combination Wrench
81734	1-1/8" Long Pattern Combination Wrench	81750	1-1/2" Full Polish Combination Wrench
81735	1-1/4" Long Pattern Combination Wrench		

GEARWRENCH® 6 Pc. 12 Point Metric Large Long Pattern Combination Wrench Set

- Long Pattern Length
- Offset Box End for Increased Access
- Surface Drive Plus™ on Open End: Stronger Grip, Reduces Fastener Rounding, Up to 25% More Torque



Cat. No.	UPC No.	Packaging	Product Weight
81922	099575819223	Boxed	10.20 lb

Cat. No.	Description	Cat. No.	Description
81751	25mm Long Pattern Combination Wrench	81753	28mm Long Pattern Combination Wrench
81752	26mm Long Pattern Combination Wrench	81744	30mm Long Pattern Combination Wrench
81743	27mm Long Pattern Combination Wrench	81745D	32mm Long Pattern Combination Wrench

GEARWRENCH® 12 Point SAE Long Pattern Full Polish Combination Wrenches

- Large Size Stamp on Open End
- Offset Box End for Better Access
- Bright, Full Polish Chrome Finish
- Made of Premium Alloy Steel
- Surface Drive Plus™ on Open End: Stronger Grip, Reduces Fastener Rounding, Up to 25% More Torque
- Surface Drive® on Box End Provides Off-Corner Loading for Better Grip and Reduced Fastener Rounding



Cat. No.	UPC No.	Packaging	Fastener Size	End A Width	End A Thickness	End B Width	End B Thickness	Overall Length	Product Weight
81650	099575816505	Carded	1/4 in	0.520 in	0.161 in	0.449 in	0.197 in	5.090 in	0.07 lb
81651D	099575816512	Carded	9/32 in	0.567 in	0.169 in	0.484 in	0.209 in	5.440 in	0.09 lb
81652D	099575816529	Carded	5/16 in	0.654 in	0.177 in	0.535 in	0.217 in	5.800 in	0.09 lb
81653	099575816536	Carded	11/32 in	0.728 in	0.185 in	0.583 in	0.244 in	6.220 in	0.11 lb
81654	099575816543	Carded	3/8 in	0.807 in	0.213 in	0.634 in	0.272 in	6.540 in	0.13 lb
81655	099575816550	Carded	7/16 in	0.894 in	0.236 in	0.685 in	0.295 in	7.290 in	0.18 lb
81656	099575816567	Carded	1/2 in	1.051 in	0.252 in	0.780 in	0.335 in	8.110 in	0.24 lb
81657	099575816574	Carded	9/16 in	1.138 in	0.276 in	0.846 in	0.366 in	8.740 in	0.26 lb
81658	099575816581	Carded	5/8 in	1.291 in	0.303 in	0.941 in	0.413 in	9.520 in	0.38 lb
81659	099575816598	Carded	11/16 in	1.382 in	0.319 in	1.016 in	0.433 in	10.230 in	0.49 lb
81660	099575816604	Carded	3/4 in	1.551 in	0.362 in	1.098 in	0.476 in	10.972 in	0.53 lb
81661	099575816611	Carded	13/16 in	1.701 in	0.390 in	1.201 in	0.520 in	11.827 in	0.73 lb
81662	099575816628	Carded	7/8 in	1.783 in	0.406 in	1.264 in	0.539 in	12.520 in	0.82 lb
81663	099575816635	Carded	15/16 in	1.945 in	0.429 in	1.327 in	0.579 in	13.252 in	1.04 lb
81664	099575816642	Carded	1 in	2.024 in	0.445 in	1.398 in	0.598 in	14.035 in	1.15 lb
81733	099575817335	Carded	1-1/16 in	2.220 in	0.469 in	1.531 in	0.650 in	14.750 in	1.43 lb
81734	099575817342	Carded	1-1/8 in	2.469 in	0.500 in	1.685 in	0.697 in	16.000 in	1.85 lb
81735	099575817359	Carded	1-1/4 in	2.634 in	0.524 in	1.811 in	0.724 in	16.000 in	2.18 lb
81749	099575817496	Carded	1-5/16 in	3.102 in	0.610 in	2.185 in	0.925 in	18.740 in	2.22 lb
81750	099575817502	Carded	1-1/2 in	3.102 in	0.610 in	2.185 in	0.925 in	19.720 in	2.25 lb

GEARWRENCH 12 Point Metric Long Pattern Full Polish Combination Wrenches

- Large Size Stamp on Open End
- Offset Box End for Better Access
- Bright, Full Polish Chrome Finish
- Made of Premium Alloy Steel
- Surface Drive Plus™ on Open End: Stronger Grip, Reduces Fastener Rounding, Up to 25% More Torque
- Surface Drive® on Box End Provides Off-Corner Loading for Better Grip and Reduced Fastener Rounding



Cat. No.	UPC No.	Packaging	Fastener Size	End A Width	End A Thickness	End B Width	End B Thickness	Overall Length	Product Weight
81736	099575817366	Carded	6 mm	0.520 in	0.161 in	0.449 in	0.197 in	5.094 in	0.07 lb
81737	099575817373	Carded	7 mm	0.567 in	0.169 in	0.484 in	0.209 in	5.445 in	0.07 lb
81665	099575816659	Carded	8 mm	0.654 in	0.177 in	0.535 in	0.217 in	5.799 in	0.09 lb
81666	099575816666	Carded	9 mm	0.728 in	0.185 in	0.583 in	0.244 in	6.220 in	0.11 lb
81667	099575816673	Carded	10 mm	0.807 in	0.213 in	0.634 in	0.272 in	6.543 in	0.13 lb
81668	099575816680	Carded	11 mm	0.894 in	0.236 in	0.685 in	0.295 in	7.291 in	0.18 lb
81669	099575816697	Carded	12 mm	0.969 in	0.244 in	0.728 in	0.327 in	7.736 in	0.18 lb
81670	099575816703	Carded	13 mm	1.051 in	0.252 in	0.780 in	0.335 in	8.114 in	0.30 lb
81671	099575816710	Carded	14 mm	1.138 in	0.276 in	0.846 in	0.366 in	8.740 in	0.32 lb
81672	099575816727	Carded	15 mm	1.213 in	0.291 in	0.890 in	0.390 in	9.134 in	0.35 lb
81673	099575816734	Carded	16 mm	1.291 in	0.303 in	0.941 in	0.413 in	9.524 in	0.40 lb
81674	099575816741	Carded	17 mm	1.382 in	0.319 in	1.016 in	0.433 in	10.232 in	0.43 lb
81675	099575816758	Carded	18 mm	1.461 in	0.339 in	1.047 in	0.453 in	10.602 in	0.49 lb
81676	099575816765	Carded	19 mm	1.550 in	0.360 in	1.080 in	0.472 in	10.970 in	0.54 lb
81677	099575816772	Carded	20 mm	1.650 in	0.381 in	1.110 in	0.491 in	11.400 in	0.62 lb
81678	099575816789	Carded	21 mm	1.700 in	0.400 in	1.140 in	0.510 in	11.830 in	0.68 lb
81679	099575816796	Carded	22 mm	1.783 in	0.406 in	1.264 in	0.539 in	12.520 in	0.69 lb
81741	099575817410	Carded	23 mm	1.870 in	0.417 in	1.287 in	0.559 in	12.752 in	0.99 lb
81742	099575817427	Carded	24 mm	1.945 in	0.429 in	1.327 in	0.579 in	13.252 in	1.00 lb
81751	099575817519	Carded	25 mm	2.024 in	0.445 in	1.398 in	0.598 in	14.035 in	1.10 lb
81752	099575817526	Carded	26 mm	2.138 in	0.449 in	1.472 in	0.622 in	14.331 in	1.12 lb
81743	099575817434	Carded	27 mm	2.220 in	0.469 in	1.531 in	0.650 in	14.752 in	1.38 lb
81753	099575817533	Carded	28 mm	2.469 in	0.500 in	1.685 in	0.697 in	16.000 in	1.89 lb
81744	099575817441	Carded	30 mm	2.555 in	0.524 in	1.685 in	0.724 in	17.000 in	2.12 lb
81745D	099575817458	Carded	32 mm	2.634 in	0.524 in	1.811 in	0.724 in	17.362 in	2.13 lb

GEARWRENCH® 28 Pc. 6 Point SAE/Metric Full Polish Combination Wrench Set

- Offset Box End for Increased Access
- Surface Drive Plus™ on Open End: Stronger Grip, Reduces Fastener Rounding, Up to 25% More Torque



Cat. No.	UPC No.	Packaging	Product Weight
81923	099575819230	Boxed	14.50 lb

Cat. No.	Description	Cat. No.	Description
81754	6mm 6 Point Full Polish Combination Wrench	81768	1/4" Full Polish Combination Wrench 6 Point
81755	7mm 6 Point Full Polish Combination Wrench	81769	5/16" Full Polish Combination Wrench 6 Point
81756	8mm 6 Point Full Polish Combination Wrench	81770	11/32" Full Polish Combination Wrench 6 Point
81757	9mm 6 Point Full Polish Combination Wrench	81771	3/8" Full Polish Combination Wrench 6 Point
81758	10mm 6 Point Full Polish Combination Wrench	81772	7/16" Full Polish Combination Wrench 6 Point
81759	11mm 6 Point Full Polish Combination Wrench	81773	1/2" Full Polish Combination Wrench 6 Point
81760D	12mm 6 Point Full Polish Combination Wrench	81774	9/16" Full Polish Combination Wrench 6 Point
81761	13mm 6 Point Full Polish Combination Wrench	81775	5/8" Full Polish Combination Wrench 6 Point
81762	14mm 6 Point Full Polish Combination Wrench	81776	11/16" Full Polish Combination Wrench 6 Point
81763	15mm 6 Point Full Polish Combination Wrench	81777	3/4" Full Polish Combination Wrench 6 Point
81764	16mm 6 Point Full Polish Combination Wrench	81778	13/16" Full Polish Combination Wrench 6 Point
81765D	17mm 6 Point Full Polish Combination Wrench	81779	7/8" Full Polish Combination Wrench 6 Point
81766	18mm 6 Point Full Polish Combination Wrench	81780D	15/16" Full Polish Combination Wrench 6 Point
81767	19mm 6 Point Full Polish Combination Wrench	81781	1" Full Polish Combination Wrench 6 Point

GEARWRENCH® 14 Pc. 6 Point SAE Full Polish Combination Wrench Set

- Offset Box End for Increased Access
- Surface Drive Plus™ on Open End: Stronger Grip, Reduces Fastener Rounding, Up to 25% More Torque



Cat. No.	UPC No.	Packaging	Product Weight
81924	099575819247	Boxed	5.15 lb

Cat. No.	Description	Cat. No.	Description
81768	1/4" Full Polish Combination Wrench 6 Point	81775	5/8" Full Polish Combination Wrench 6 Point
81769	5/16" Full Polish Combination Wrench 6 Point	81776	11/16" Full Polish Combination Wrench 6 Point
81770	11/32" Full Polish Combination Wrench 6 Point	81777	3/4" Full Polish Combination Wrench 6 Point
81771	3/8" Full Polish Combination Wrench 6 Point	81778	13/16" Full Polish Combination Wrench 6 Point
81772	7/16" Full Polish Combination Wrench 6 Point	81779	7/8" Full Polish Combination Wrench 6 Point
81773	1/2" Full Polish Combination Wrench 6 Point	81780D	15/16" Full Polish Combination Wrench 6 Point
81774	9/16" Full Polish Combination Wrench 6 Point	81781	1" Full Polish Combination Wrench 6 Point

GEARWRENCH® 14 Pc. 6 Point Metric Full Polish Combination Wrench Set

- Offset Box End for Increased Access
- Surface Drive Plus™ on Open End: Stronger Grip, Reduces Fastener Rounding, Up to 25% More Torque



Cat. No.	UPC No.	Packaging	Product Weight
81925	099575819254	Boxed	4.85 lb

Cat. No.	Description	Cat. No.	Description
81754	6mm 6 Point Full Polish Combination Wrench	81761	13mm 6 Point Full Polish Combination Wrench
81755	7mm 6 Point Full Polish Combination Wrench	81762	14mm 6 Point Full Polish Combination Wrench
81756	8mm 6 Point Full Polish Combination Wrench	81763	15mm 6 Point Full Polish Combination Wrench
81757	9mm 6 Point Full Polish Combination Wrench	81764	16mm 6 Point Full Polish Combination Wrench
81758	10mm 6 Point Full Polish Combination Wrench	81765D	17mm 6 Point Full Polish Combination Wrench
81759	11mm 6 Point Full Polish Combination Wrench	81766	18mm 6 Point Full Polish Combination Wrench
81760D	12mm 6 Point Full Polish Combination Wrench	81767	19mm 6 Point Full Polish Combination Wrench

GEARWRENCH® 6 Point SAE Full Polish Combination Wrenches

- Large Size Stamp on Open End
- Offset Box End for Better Access
- Bright, Full Polish Chrome Finish
- Made of Premium Alloy Steel
- Surface Drive Plus™ on Open End: Stronger Grip, Reduces Fastener Rounding, Up to 25% More Torque
- Surface Drive® on Box End Provides Off-Corner Loading for Better Grip and Reduced Fastener Rounding



Cat. No.	UPC No.	Packaging	Fastener Size	End A Width	End A Thickness	End B Width	End B Thickness	Overall Length	Product Weight
81768	099575817687	Carded	1/4 in	0.520 in	0.161 in	0.449 in	0.197 in	5.094 in	0.05 lb
81769	099575817694	Carded	5/16 in	0.567 in	0.169 in	0.484 in	0.209 in	5.445 in	0.06 lb
81770	099575817700	Carded	11/32 in	0.728 in	0.185 in	0.583 in	0.244 in	6.220 in	0.07 lb
81771	099575817717	Carded	3/8 in	0.807 in	0.213 in	0.634 in	0.272 in	6.543 in	0.09 lb
81772	099575817724	Carded	7/16 in	0.894 in	0.236 in	0.685 in	0.295 in	7.291 in	0.12 lb
81773	099575817731	Carded	1/2 in	1.051 in	0.252 in	0.780 in	0.335 in	8.114 in	0.14 lb
81774	099575817748	Carded	9/16 in	1.138 in	0.276 in	0.846 in	0.366 in	8.740 in	0.20 lb
81775	099575817755	Carded	5/8 in	1.291 in	0.303 in	0.941 in	0.413 in	9.524 in	0.27 lb
81776	099575817762	Carded	11/16 in	1.382 in	0.319 in	1.016 in	0.433 in	10.232 in	0.33 lb
81777	099575817779	Carded	3/4 in	1.551 in	0.362 in	1.098 in	0.476 in	10.972 in	0.41 lb
81778	099575817786	Carded	13/16 in	1.701 in	0.390 in	1.201 in	0.520 in	11.827 in	0.53 lb
81779	099575817793	Carded	7/8 in	1.783 in	0.406 in	1.264 in	0.539 in	12.520 in	0.64 lb
81780D	099575817809	Carded	15/16 in	1.945 in	0.429 in	1.327 in	0.579 in	13.252 in	0.71 lb
81781	099575817816	Carded	1 in	2.024 in	0.445 in	1.398 in	0.598 in	14.035 in	0.90 lb

GEARWRENCH® 6 Point Metric Full Polish Combination Wrenches

- Large Size Stamp on Open End
- Offset Box End for Better Access
- Bright, Full Polish Chrome Finish
- Made of Premium Alloy Steel
- Surface Drive Plus™ on Open End: Stronger Grip, Reduces Fastener Rounding, Up to 25% More Torque
- Surface Drive® on Box End Provides Off-Corner Loading for Better Grip and Reduced Fastener Rounding



Cat. No.	UPC No.	Packaging	Fastener Size	End A Width	End A Thickness	End B Width	End B Thickness	Overall Length	Product Weight
81754	099575817540	Carded	6 mm	0.520 in	0.161 in	0.449 in	0.197 in	5.094 in	0.06 lb
81755	099575817557	Carded	7 mm	0.567 in	0.169 in	0.484 in	0.209 in	5.445 in	0.06 lb
81756	099575817564	Carded	8 mm	0.654 in	0.177 in	0.535 in	0.217 in	5.799 in	0.07 lb
81757	099575817571	Carded	9 mm	0.728 in	0.185 in	0.583 in	0.244 in	6.220 in	0.09 lb
81758	099575817588	Carded	10 mm	0.807 in	0.213 in	0.634 in	0.272 in	6.543 in	0.11 lb
81759	099575817595	Carded	11 mm	0.894 in	0.236 in	0.685 in	0.295 in	7.291 in	0.12 lb
81760D	099575817601	Carded	12 mm	0.969 in	0.244 in	0.728 in	0.327 in	7.736 in	0.15 lb
81761	099575817618	Carded	13 mm	1.051 in	0.252 in	0.780 in	0.335 in	8.114 in	0.18 lb
81762	099575817625	Carded	14 mm	1.138 in	0.276 in	0.846 in	0.366 in	8.740 in	0.21 lb
81763	099575817632	Carded	15 mm	1.213 in	0.291 in	0.890 in	0.390 in	9.134 in	0.24 lb
81764	099575817649	Carded	16 mm	1.291 in	0.303 in	0.941 in	0.413 in	9.524 in	0.34 lb
81765D	099575817656	Carded	17 mm	1.382 in	0.319 in	1.016 in	0.433 in	10.232 in	0.41 lb
81766	099575817663	Carded	18 mm	1.461 in	0.339 in	1.047 in	0.453 in	10.602 in	0.42 lb
81767	099575817670	Carded	19 mm	1.551 in	0.362 in	1.098 in	0.476 in	10.972 in	0.55 lb

GEARWRENCH® 20 Pc. 12 Point SAE/Metric Stubby Full Polish Combination Wrench Set

- Offset Box End for Increased Access
- Surface Drive Plus™ on Open End: Stronger Grip, Reduces Fastener Rounding, Up to 25% More Torque



Cat. No.	UPC No.	Packaging	Product Weight
81903	099575819032	Blow Mold Tray	5.25 lb

Cat. No.	Description	Cat. No.	Description
81624	3/8" Combination Stubby Wrench	81634	10mm Combination Stubby Wrench
81625	7/16" Combination Stubby Wrench	81635	11mm Combination Stubby Wrench
81626	1/2" Combination Stubby Wrench	81636	12mm Combination Stubby Wrench
81627	9/16" Combination Stubby Wrench	81637	13mm Combination Stubby Wrench
81628	5/8" Combination Stubby Wrench	81638	14mm Combination Stubby Wrench
81629	11/16" Combination Stubby Wrench	81639	15mm Combination Stubby Wrench
81630	3/4" Combination Stubby Wrench	81640	16mm Combination Stubby Wrench
81631	13/16" Combination Stubby Wrench	81641	17mm Combination Stubby Wrench
81632	7/8" Combination Stubby Wrench	81642	18mm Combination Stubby Wrench
81633	15/16" Combination Stubby Wrench	81643	19mm Combination Stubby Wrench

GEARWRENCH® 10 Pc. 12 Point SAE Stubby Full Polish Combination Wrench Set

- Offset Box End for Increased Access
- Surface Drive Plus™ on Open End: Stronger Grip, Reduces Fastener Rounding, Up to 25% More Torque



Cat. No.	UPC No.	Packaging	Product Weight
81905	099575819056	Blow Mold Tray	2.87 lb

Cat. No.	Description	Cat. No.	Description
81624	3/8" Combination Stubby Wrench	81629	11/16" Combination Stubby Wrench
81625	7/16" Combination Stubby Wrench	81630	3/4" Combination Stubby Wrench
81626	1/2" Combination Stubby Wrench	81631	13/16" Combination Stubby Wrench
81627	9/16" Combination Stubby Wrench	81632	7/8" Combination Stubby Wrench
81628	5/8" Combination Stubby Wrench	81633	15/16" Combination Stubby Wrench

GEARWRENCH® 10 Pc. 12 Point Metric Stubby Full Polish Combination Wrench Set

- Offset Box End for Increased Access
- Surface Drive Plus™ on Open End: Stronger Grip, Reduces Fastener Rounding, Up to 25% More Torque



Cat. No.	UPC No.	Packaging	Product Weight
81904	099575819049	Blow Mold Tray	2.05 lb

Cat. No.	Description	Cat. No.	Description
81634	10mm Combination Stubby Wrench	81639	15mm Combination Stubby Wrench
81635	11mm Combination Stubby Wrench	81640	16mm Combination Stubby Wrench
81636	12mm Combination Stubby Wrench	81641	17mm Combination Stubby Wrench
81637	13mm Combination Stubby Wrench	81642	18mm Combination Stubby Wrench
81638	14mm Combination Stubby Wrench	81643	19mm Combination Stubby Wrench

GEARWRENCH® 12 Point SAE Stubby Full Polish Combination Wrenches

- Large Size Stamp on Open End
- Offset Box End for Better Access
- Bright, Full Polish Chrome Finish
- Made of Premium Alloy Steel
- Surface Drive Plus™ on Open End: Stronger Grip, Reduces Fastener Rounding, Up to 25% More Torque
- Surface Drive® on Box End Provides Off-Corner Loading for Better Grip and Reduced Fastener Rounding



Cat. No.	UPC No.	Packaging	Fastener Size	End A Width	End A Thickness	End B Width	End B Thickness	Overall Length	Product Weight
81624	099575816246	Carded	3/8 in	0.807 in	0.181 in	0.634 in	0.232 in	3.752 in	0.09 lb
81625	099575816253	Carded	7/16 in	0.894 in	0.197 in	0.685 in	0.256 in	4.067 in	0.11 lb
81626	099575816260	Carded	1/2 in	1.051 in	0.220 in	0.780 in	0.303 in	4.268 in	0.13 lb
81627	099575816277	Carded	9/16 in	1.138 in	0.236 in	0.846 in	0.327 in	4.543 in	0.15 lb
81628	099575816284	Carded	5/8 in	1.291 in	0.260 in	0.941 in	0.370 in	4.862 in	0.18 lb
81629	099575816291	Carded	11/16 in	1.382 in	0.276 in	1.016 in	0.390 in	5.020 in	0.22 lb
81630	099575816307	Carded	3/4 in	1.551 in	0.315 in	1.098 in	0.429 in	5.492 in	0.29 lb
81631	099575816314	Carded	13/16 in	1.701 in	0.339 in	1.201 in	0.469 in	5.752 in	0.40 lb
81632	099575816321	Carded	7/8 in	1.783 in	0.354 in	1.276 in	0.488 in	6.252 in	0.44 lb
81633	099575816338	Carded	15/16 in	1.945 in	0.378 in	1.327 in	0.528 in	6.500 in	0.53 lb

GEARWRENCH® 12 Point Metric Stubby Full Polish Combination Wrenches

- Large Size Stamp on Open End
- Offset Box End for Better Access
- Bright, Full Polish Chrome Finish
- Made of Premium Alloy Steel
- Surface Drive Plus™ on Open End: Stronger Grip, Reduces Fastener Rounding, Up to 25% More Torque
- Surface Drive® on Box End Provides Off-Corner Loading for Better Grip and Reduced Fastener Rounding



Cat. No.	UPC No.	Packaging	Fastener Size	End A Width	End A Thickness	End B Width	End B Thickness	Overall Length	Product Weight
81634	099575816345	Carded	10 mm	0.807 in	0.181 in	0.634 in	0.232 in	3.752 in	0.11 lb
81635	099575816352	Carded	11 mm	0.894 in	0.197 in	0.685 in	0.256 in	4.067 in	0.11 lb
81636	099575816369	Carded	12 mm	0.969 in	0.209 in	0.728 in	0.276 in	4.189 in	0.11 lb
81637	099575816376	Carded	13 mm	1.051 in	0.220 in	0.780 in	0.303 in	4.268 in	0.13 lb
81638	099575816383	Carded	14 mm	1.138 in	0.236 in	0.846 in	0.327 in	4.543 in	0.15 lb
81639	099575816390	Carded	15 mm	1.213 in	0.248 in	0.890 in	0.346 in	4.701 in	0.18 lb
81640	099575816406	Carded	16 mm	1.291 in	0.260 in	0.941 in	0.370 in	4.862 in	0.18 lb
81641	099575816413	Carded	17 mm	1.382 in	0.276 in	1.016 in	0.390 in	5.020 in	0.22 lb
81642	099575816420	Carded	18 mm	1.461 in	0.295 in	1.047 in	0.409 in	5.142 in	0.24 lb
81643	099575816437	Carded	19 mm	1.551 in	0.315 in	1.098 in	0.429 in	5.492 in	0.29 lb

GEARWRENCH® 5 Pc. SAE Ratcheting Flex Flare Nut Wrench Set

- Quickly Ratchet Flare Nuts and Bolts Without Removing the Wrench From the Fastener
- Flex Head Provides Access to Difficult-To-Reach Hose Fittings and Gets Around Other Obstructions
- Flare Nut Wrench Head Easily Slips Over Lines
- Flex Flare Nut Wrench Design Exceeds ANSI Requirements for Strength and Durability



SAE

Cat. No.	Packaging	Product Weight
89100	Blow Mold Tray	2.55 lb

Cat. No.	Description	Cat. No.	Description
89109	Ratcheting Flex Flare Nut Wrench 1/4" x 5/16"	89112	Ratcheting Flex Flare Nut Wrench 5/8" x 11/16"
89110	Ratcheting Flex Flare Nut Wrench 3/8" x 7/16"	89113	Ratcheting Flex Flare Nut Wrench 3/4" x 7/8"
89111	Ratcheting Flex Flare Nut Wrench 1/2" x 9/16"		

GEARWRENCH® 6 Pc. Metric Ratcheting Flex Flare Nut Wrench Set

- Quickly Ratchet Flare Nuts and Bolts Without Removing the Wrench From the Fastener
- Flex Head Provides Access to Difficult-To-Reach Hose Fittings and Gets Around Other Obstructions
- Flare Nut Wrench Head Easily Slips Over Lines
- Flex Flare Nut Wrench Design Exceeds ANSI Requirements for Strength and Durability



mm

Cat. No.	UPC No.	Packaging	Product Weight
89101D	099575891014	Blow Mold Tray	2.93 lb

Cat. No.	Description	Cat. No.	Description
89102	Ratcheting Flex Flare Nut Wrench 9x11mm	89105	Ratcheting Flex Flare Nut Wrench 15x17mm
89103	Ratcheting Flex Flare Nut Wrench 10x12mm	89106	Ratcheting Flex Flare Nut Wrench 16x18mm
89104	Ratcheting Flex Flare Nut Wrench 13x14mm	89107	Ratcheting Flex Flare Nut Wrench 19x21mm

GEARWRENCH® SAE Ratcheting Flex Flare Nut Wrenches

- Quickly Ratchet Flare Nuts and Bolts Without Removing the Wrench From the Fastener
- Flex Head Provides Access to Difficult-To-Reach Hose Fittings and Gets Around Other Obstructions
- Flare Nut Wrench Head Easily Slips Over Lines
- Flex Flare Nut Wrench Design Exceeds ANSI Requirements for Strength and Durability



SAE

Cat. No.	Packaging	End A Fastener Size	End A Width	End A Thickness	End B Fastener Size	End B Width	End B Thickness	End A Slot Width	Overall Length	Product Weight
89109	Carded	1/4 in	0.614 in	0.256 in	5/16 in	0.709 in	0.256 in	0.124 in	6.444 in	0.23 lb
89110	Carded	3/8 in	0.835 in	0.394 in	7/16 in	0.898 in	0.394 in	0.203 in	8.597 in	0.41 lb
89111	Carded	1/2 in	1.031 in	0.417 in	9/16 in	1.118 in	0.453 in	0.329 in	10.130 in	0.58 lb
89112	Carded	5/8 in	1.228 in	0.453 in	11/16 in	1.362 in	0.512 in	0.419 in	11.262 in	0.87 lb
89113	Carded	3/4 in	1.394 in	0.559 in	7/8 in	1.598 in	0.579 in	0.451 in	13.243 in	1.28 lb

GEARWRENCH® Metric Ratcheting Flex Flare Nut Wrenches

- Quickly Ratchet Flare Nuts and Bolts Without Removing the Wrench From the Fastener
- Flex Head Provides Access to Difficult-To-Reach Hose Fittings and Gets Around Other Obstructions
- Flare Nut Wrench Head Easily Slips Over Lines
- Flex Flare Nut Wrench Design Exceeds ANSI Requirements for Strength and Durability



Cat. No.	Packaging	End A Fastener Size	End A Width	End A Thickness	End B Fastener Size	End B Width	End B Thickness	End A Slot Width	Overall Length	Product Weight
89102	Carded	9 mm	0.811 in	0.374 in	11 mm	0.906 in	0.394 in	0.199 in	7.769 in	0.36 lb
89103	Carded	10 mm	0.866 in	0.394 in	12 mm	0.969 in	0.417 in	0.230 in	9.190 in	0.43 lb
89104	Carded	13 mm	1.024 in	0.417 in	14 mm	1.063 in	0.453 in	0.348 in	10.290 in	0.58 lb
89105	Carded	15 mm	1.150 in	0.453 in	17 mm	1.228 in	0.512 in	0.419 in	10.909 in	0.78 lb
89106	Carded	16 mm	1.189 in	0.453 in	18 mm	1.319 in	0.559 in	0.419 in	11.833 in	0.90 lb
89107	Carded	19 mm	1.378 in	0.559 in	21 mm	1.535 in	0.579 in	0.526 in	12.996 in	1.28 lb

GEARWRENCH® 5 Pc. SAE Flex Flare Nut Wrench Set

- Size Stamped on Both Sides
- Flex Head Wrench Ends for Increased Access
- Full Polish Chrome



Cat. No.	UPC No.	Packaging	Product Weight
81910	099575819100	Carded	2.78 lb

Cat. No.	Description	Cat. No.	Description
81693	Flex Flare Nut Wrench 1/4" x 5/16"	81696	Flex Flare Nut Wrench 5/8" x 11/16"
81694	Flex Flare Nut Wrench 3/8" x 7/16"	81697	Flex Flare Nut Wrench 3/4" x 7/8"
81695	Flex Flare Nut Wrench 1/2" x 9/16"		

GEARWRENCH® 3 Pc. SAE Flex Flare Nut Wrench Set

- Size Stamped on Both Sides
- Flex Head Wrench Ends for Increased Access
- Full Polish Chrome



Cat. No.	UPC No.	Packaging	Product Weight
81914	099575819148	Carded	1.28 lb

Cat. No.	Description	Cat. No.	Description
81694	Flex Flare Nut Wrench 3/8" x 7/16"	81696	Flex Flare Nut Wrench 5/8" x 11/16"
81695	Flex Flare Nut Wrench 1/2" x 9/16"		

GEARWRENCH® 6 Pc. Metric Flex Flare Nut Wrench Set

- Size Stamped on Both Sides
- Flex Head Wrench Ends for Increased Access
- Full Polish Chrome



mm

Cat. No.	UPC No.	Packaging	Product Weight
81911D	099575819117	Carded	3.47 lb

Cat. No.	Description	Cat. No.	Description
81686	Flex Flare Nut Wrench 9x11mm	81689	Flex Flare Nut Wrench 15x17mm
81687	Flex Flare Nut Wrench 10x12mm	81690	Flex Flare Nut Wrench 16x18mm
81688	Flex Flare Nut Wrench 13x14mm	81692	Flex Flare Nut Wrench 19x21mm

GEARWRENCH® 3 Pc. Metric Flex Flare Nut Wrench Set

- Size Stamped on Both Sides
- Flex Head Wrench Ends for Increased Access
- Full Polish Chrome



mm

Cat. No.	UPC No.	Packaging	Product Weight
81915	099575819155	Carded	0.97 lb

Cat. No.	Description	Cat. No.	Description
81686	Flex Flare Nut Wrench 9x11mm	81688	Flex Flare Nut Wrench 13x14mm
81687	Flex Flare Nut Wrench 10x12mm		

GEARWRENCH® SAE Flex Flare Nut Wrenches

- Size Stamped on Both Sides and Head
- Flex Heads for Increased Access
- Full Polish Chrome



SAE

Cat. No.	UPC No.	Packaging	End A Fastener Size	End A Width	End A Thickness	End B Fastener Size	End B Width	End B Thickness	Overall Length	Product Weight
81693	099575816932	Carded	1/4 in	0.630 in	0.720 in	5/16 in	0.256 in	0.256 in	5.709 in	0.08 lb
81694	099575816949	Carded	3/8 in	0.772 in	0.811 in	7/16 in	0.394 in	0.394 in	7.130 in	0.20 lb
81695	099575816956	Carded	1/2 in	0.890 in	0.953 in	9/16 in	0.417 in	0.453 in	8.429 in	0.29 lb
81696	099575816963	Carded	5/8 in	1.122 in	1.181 in	11/16 in	0.453 in	0.512 in	9.303 in	0.57 lb
81697	099575816970	Carded	3/4 in	1.252 in	1.370 in	7/8 in	0.559 in	0.579 in	11.146 in	0.58 lb

GEARWRENCH® Metric Flex Flare Nut Wrenches

- Size Stamped on Both Sides and Head
- Flex Heads for Increased Access
- Full Polish Chrome



Cat. No.	UPC No.	Packaging	End A Fastener Size	End A Width	End A Thickness	End B Fastener Size	End B Width	End B Thickness	Overall Length	Product Weight
81686	099575816864	Carded	9 mm	0.732 in	0.811 in	11 mm	0.374 in	0.394 in	6.264 in	0.21 lb
81687	099575816871	Carded	10 mm	0.772 in	0.850 in	12 mm	0.394 in	0.417 in	7.563 in	0.26 lb
81688	099575816888	Carded	13 mm	0.890 in	0.953 in	14 mm	0.417 in	0.453 in	8.429 in	0.36 lb
81689	099575816895	Carded	15 mm	1.122 in	1.181 in	17 mm	0.453 in	0.512 in	9.303 in	0.36 lb
81690	099575816901	Carded	16 mm	1.122 in	1.252 in	18 mm	0.453 in	0.559 in	10.169 in	0.63 lb
81692	099575816925	Carded	19 mm	1.465 in	1.370 in	21 mm	0.559 in	0.579 in	11.146 in	0.58 lb

GEARWRENCH® 6 Pc. SAE Flare Nut Wrench Set

- Size Stamped on Both Sides and Head
- 15° Offset Wrench Ends
- Full Polish Chrome



Cat. No.	UPC No.	Packaging	Product Weight
81907	099575819070	Blow Mold Tray	2.43 lb

Cat. No.	Description	Cat. No.	Description
81680	1/4" x 5/16" Flare Nut Wrench	81683	5/8" x 11/16" Flare Nut Wrench
81681	3/8" x 7/16" Flare Nut Wrench	81684	5/8" x 3/4" Flare Nut Wrench
81682	1/2" x 9/16" Flare Nut Wrench	81685	3/4" x 7/8" Flare Nut Wrench

GEARWRENCH® 6 Pc. Metric Flare Nut Wrench Set

- Size Stamped on Both Sides and Head
- 15° Offset Wrench Ends
- Full Polish Chrome



Cat. No.	UPC No.	Packaging	Product Weight
81906	099575819063	Blow Mold Tray	2.65 lb

Cat. No.	Description	Cat. No.	Description
81644	9 x 11mm Flare Nut Wrench	81647	15 x 17mm Flare Nut Wrench
81645	10 x 12mm Flare Nut Wrench	81648	16 x 18mm Flare Nut Wrench
81646	13 x 14mm Flare Nut Wrench	81649	19 x 21mm Flare Nut Wrench

GEARWRENCH® SAE Flare Nut Wrenches

- Size Stamped on Both Sides and Head
- 15° Offset Heads
- Full Polish Chrome



Cat. No.	UPC No.	Packaging	End A Fastener Size	End A Width	End A Thickness	End B Fastener Size	End B Width	End B Thickness	Overall Length	Product Weight
81680	099575816802	Carded	1/4 in	0.630 in	0.681 in	5/16 in	0.236 in	0.268 in	5.118 in	0.11 lb
81681	099575816819	Carded	3/8 in	0.764 in	0.870 in	7/16 in	0.323 in	0.350 in	5.984 in	0.15 lb
81682	099575816826	Carded	1/2 in	0.980 in	1.028 in	9/16 in	0.386 in	0.409 in	7.035 in	0.26 lb
81683	099575816833	Carded	5/8 in	1.083 in	1.197 in	11/16 in	0.441 in	0.476 in	7.614 in	0.39 lb
81684	099575816840	Carded	5/8 in	1.142 in	1.260 in	3/4 in	0.457 in	0.496 in	8.287 in	0.46 lb
81685	099575816857	Carded	3/4 in	1.323 in	1.461 in	7/8 in	0.516 in	0.539 in	8.858 in	0.60 lb

GEARWRENCH® Metric Flare Nut Wrenches

- Size Stamped on Both Sides and Head
- 15° Offset Heads
- Full Polish Chrome



Cat. No.	UPC No.	Packaging	End A Fastener Size	End A Width	End A Thickness	End B Fastener Size	End B Width	End B Thickness	Overall Length	Product Weight
81644	099575816444	Carded	9 mm	0.764 in	0.870 in	11 mm	0.323 in	0.350 in	5.984 in	0.20 lb
81645	099575816451	Carded	10 mm	0.827 in	0.925 in	12 mm	0.339 in	0.370 in	6.535 in	0.22 lb
81646	099575816468	Carded	13 mm	0.980 in	1.028 in	14 mm	0.386 in	0.409 in	7.035 in	0.29 lb
81647	099575816475	Carded	15 mm	1.083 in	1.197 in	17 mm	0.441 in	0.476 in	7.614 in	0.40 lb
81648	099575816482	Carded	16 mm	1.142 in	1.260 in	18 mm	0.457 in	0.496 in	8.287 in	0.46 lb
81649	099575816499	Carded	19 mm	1.323 in	1.461 in	21 mm	0.516 in	0.539 in	8.858 in	0.62 lb

GEARWRENCH® 11 Pc. 3/8" Drive SAE Ratcheting Crowfoot Wrench Set

- Quickly Ratchet Nuts and Bolts Without Removing the Wrench From the Fastener
- Exceeds ASME Requirements for Torque Performance
- Size Laser Etched on Both Sides of Head for Easy Identification
- Bright Chrome Finish



Cat. No.	UPC No.	Packaging	Product Weight
89118	099575891182	Blow Mold Case	2.20 lb

Cat. No.	Description	Cat. No.	Description
89120	3/8" Drive Ratcheting Crowfoot Wrench 3/8"	89126	3/8" Drive Ratcheting Crowfoot Wrench 3/4"
89121	3/8" Drive Ratcheting Crowfoot Wrench 7/16"	89127	3/8" Drive Ratcheting Crowfoot Wrench 13/16"
89122	3/8" Drive Ratcheting Crowfoot Wrench 1/2"	89128	3/8" Drive Ratcheting Crowfoot Wrench 7/8"
89123	3/8" Drive Ratcheting Crowfoot Wrench 9/16"	89129	3/8" Drive Ratcheting Crowfoot Wrench 15/16"
89124	3/8" Drive Ratcheting Crowfoot Wrench 5/8"	89130	3/8" Drive Ratcheting Crowfoot Wrench 1"
89125	3/8" Drive Ratcheting Crowfoot Wrench 11/16"		

GEARWRENCH® 10 Pc. 3/8" Drive Metric Ratcheting Crowfoot Wrench Set

- Quickly Ratchet Nuts and Bolts Without Removing the Wrench From the Fastener
- Exceeds ASME Requirements for Torque Performance
- Size Laser Etched on Both Sides of Head for Easy Identification
- Bright Chrome Finish



Cat. No.	UPC No.	Packaging	Product Weight
89119	099575891199	Blow Mold Case	1.30 lb

Cat. No.	Description	Cat. No.	Description
89140	3/8" Drive Ratcheting Crowfoot Wrench 10mm	89145	3/8" Drive Ratcheting Crowfoot Wrench 15mm
89141	3/8" Drive Ratcheting Crowfoot Wrench 11mm	89146	3/8" Drive Ratcheting Crowfoot Wrench 16mm
89142	3/8" Drive Ratcheting Crowfoot Wrench 12mm	89147	3/8" Drive Ratcheting Crowfoot Wrench 17mm
89143	3/8" Drive Ratcheting Crowfoot Wrench 13mm	89148	3/8" Drive Ratcheting Crowfoot Wrench 18mm
89144	3/8" Drive Ratcheting Crowfoot Wrench 14mm	89149	3/8" Drive Ratcheting Crowfoot Wrench 19mm

GEARWRENCH® 3/8" Drive SAE Ratcheting Crowfoot Wrenches

- Quickly Ratchet Nuts and Bolts Without Removing the Wrench From the Fastener
- Exceeds ASME Requirements for Torque Performance
- Size Laser Etched on Both Sides of Head for Easy Identification
- Bright Chrome Finish



Cat. No.	UPC No.	Packaging	Fastener Size	End A Width	End A Thickness	End A Length	Product Weight
89120	099575891205	Carded	3/8 in	0.909 in	0.224 in	1.378 in	0.04 lb
89121	099575891212	Carded	7/16 in	0.988 in	0.252 in	1.417 in	0.05 lb
89122	099575891229	Carded	1/2 in	1.134 in	0.319 in	1.575 in	0.09 lb
89123	099575891236	Carded	9/16 in	1.244 in	0.327 in	1.654 in	0.10 lb
89124	099575891243	Carded	5/8 in	1.350 in	0.346 in	1.772 in	0.12 lb
89125	099575891250	Carded	11/16 in	1.476 in	0.362 in	1.890 in	0.14 lb
89126	099575891267	Carded	3/4 in	1.602 in	0.374 in	2.047 in	0.19 lb
89127	099575891274	Carded	13/16 in	1.803 in	0.425 in	2.205 in	0.24 lb
89128	099575891281	Carded	7/8 in	1.866 in	0.449 in	2.283 in	0.29 lb
89129	099575891298	Carded	15/16 in	1.992 in	0.465 in	2.362 in	0.32 lb
89130	099575891304	Carded	1 in	2.087 in	0.476 in	2.441 in	0.32 lb

GEARWRENCH® 3/8" Drive Metric Ratcheting Crowfoot Wrenches

- Quickly Ratchet Nuts and Bolts Without Removing the Wrench From the Fastener
- Exceeds ASME Requirements for Torque Performance
- Size Laser Etched on Both Sides of Head for Easy Identification
- Bright Chrome Finish



mm

Cat. No.	UPC No.	Packaging	Fastener Size	End A Width	End A Thickness	End A Length	Product Weight
89140	099575891403	Carded	10 mm	0.909 in	0.224 in	1.378 in	0.04 lb
89141	099575891410	Carded	11 mm	0.988 in	0.252 in	1.417 in	0.05 lb
89142	099575891427	Carded	12 mm	1.094 in	0.291 in	1.496 in	0.09 lb
89143	099575891434	Carded	13 mm	1.134 in	0.319 in	1.575 in	0.10 lb
89144	099575891441	Carded	14 mm	1.244 in	0.327 in	1.654 in	0.12 lb
89145	099575891458	Carded	15 mm	1.331 in	0.327 in	1.693 in	0.14 lb
89146	099575891465	Carded	16 mm	1.350 in	0.346 in	1.772 in	0.19 lb
89147	099575891472	Carded	17 mm	1.476 in	0.362 in	1.890 in	0.24 lb
89148	099575891489	Carded	18 mm	1.539 in	0.370 in	1.969 in	0.29 lb
89149	099575891496	Carded	19 mm	1.602 in	0.374 in	2.047 in	0.32 lb

GEARWRENCH® 11 Pc. 3/8" Drive SAE Crowfoot Wrench Set

- Premium Alloy CV Steel
- Includes Blow Mold Tray



SAE

Cat. No.	UPC No.	Packaging	Product Weight
81908	099575819087	Blow Mold Case	1.98 lb

Cat. No.	Description	Cat. No.	Description
81603	3/8" Drive Crowfoot Wrench 3/8"	81609	3/8" Drive Crowfoot Wrench 3/4"
81604	3/8" Drive Crowfoot Wrench 7/16"	81610	3/8" Drive Crowfoot Wrench 13/16"
81605	3/8" Drive Crowfoot Wrench 1/2"	81611D	3/8" Drive Crowfoot Wrench 7/8"
81606	3/8" Drive Crowfoot Wrench 9/16"	81612D	3/8" Drive Crowfoot Wrench 15/16"
81607	3/8" Drive Crowfoot Wrench 5/8"	81613	3/8" Drive Crowfoot Wrench 1"
81608	3/8" Drive Crowfoot Wrench 11/16"		

GEARWRENCH® 10 Pc. 3/8" Drive Metric Crowfoot Wrench Set

- Premium Alloy CV Steel
- Includes Blow Mold Tray



Cat. No.	UPC No.	Packaging	Product Weight
81909	099575819094	Blow Mold Case	1.43 lb

Cat. No.	Description	Cat. No.	Description
81614	3/8" Drive Crowfoot Wrench 10mm	81619	3/8" Drive Crowfoot Wrench 15mm
81615	3/8" Drive Crowfoot Wrench 11mm	81620	3/8" Drive Crowfoot Wrench 16mm
81616	3/8" Drive Crowfoot Wrench 12mm	81621	3/8" Drive Crowfoot Wrench 17mm
81617	3/8" Drive Crowfoot Wrench 13mm	81622	3/8" Drive Crowfoot Wrench 18mm
81618	3/8" Drive Crowfoot Wrench 14mm	81623	3/8" Drive Crowfoot Wrench 19mm

GEARWRENCH® 3/8" Drive Metric Crowfoot Wrenches

- Premium Alloy CV Steel



Cat. No.	UPC No.	Packaging	Fastener Size	End A Width	End A Thickness	End B Width	Overall Length	Product Weight
81614	099575816147	Carded	10 mm	0.906 in	0.118 in	0.709 in	1.300 in	0.09 lb
81615	099575816154	Carded	11 mm	0.906 in	0.118 in	0.709 in	1.380 in	0.09 lb
81616	099575816161	Carded	12 mm	0.906 in	0.118 in	0.709 in	1.378 in	0.09 lb
81617	099575816178	Carded	13 mm	1.024 in	0.118 in	0.709 in	1.417 in	0.09 lb
81618	099575816185	Carded	14 mm	1.100 in	0.118 in	0.709 in	1.570 in	0.09 lb
81619	099575816192	Carded	15 mm	1.260 in	0.236 in	0.709 in	1.654 in	0.12 lb
81620	099575816208	Carded	16 mm	1.260 in	0.236 in	0.709 in	1.654 in	0.12 lb
81621	099575816215	Carded	17 mm	1.378 in	0.276 in	0.709 in	1.772 in	0.12 lb
81622	099575816222	Carded	18 mm	1.378 in	0.276 in	0.709 in	1.772 in	0.13 lb
81623	099575816239	Carded	19 mm	1.575 in	0.276 in	0.748 in	1.969 in	0.16 lb

GEARWRENCH® 3/8" Drive SAE Crowfoot Wrenches

■ Premium Alloy CV Steel



Cat. No.	UPC No.	Packaging	Fastener Size	End A Width	End A Thickness	End B Width	Overall Length	Product Weight
81603	099575816031	Carded	3/8 in	0.866 in	0.118 in	0.709 in	1.299 in	0.09 lb
81604	099575816048	Carded	7/16 in	0.945 in	0.118 in	0.709 in	1.378 in	0.09 lb
81605	099575816055	Carded	1/2 in	1.024 in	0.157 in	0.709 in	1.417 in	0.09 lb
81606	099575816062	Carded	9/16 in	1.142 in	0.157 in	0.709 in	1.535 in	0.09 lb
81607	099575816079	Carded	5/8 in	1.260 in	0.236 in	0.709 in	1.614 in	0.13 lb
81608	099575816086	Carded	11/16 in	1.378 in	0.236 in	0.709 in	1.772 in	0.13 lb
81609	099575816093	Carded	3/4 in	1.575 in	0.236 in	0.866 in	1.890 in	0.15 lb
81610	099575816109	Carded	13/16 in	1.732 in	0.276 in	1.023 in	2.047 in	0.22 lb
81611D	099575816116	Carded	7/8 in	1.819 in	0.315 in	1.023 in	2.204 in	0.22 lb
81612D	099575816123	Carded	15/16 in	2.046 in	0.354 in	1.180 in	2.361 in	0.29 lb
81613	099575816130	Carded	1 in	2.203 in	0.393 in	1.337 in	2.518 in	0.29 lb

GEARWRENCH® 5 Pc. SAE 40° Deep Offset Box Wrench Set

- 40° Deep Offset for Fastener Access
- Made of Premium Alloy Steel
- Bright, Full Polish Chrome Finish
- Surface Drive® on Box End Provides Off-Corner Loading for Better Grip and Reduced Fastener Rounding



Cat. No.	UPC No.	Packaging	Product Weight
81926	099575819261	Carded	3.05 lb

Cat. No.	Description	Cat. No.	Description
81787	3/8 x 7/16 40° Deep Offset Box Wrench	81790	13/16" x 7/8" 40° Deep Offset Box Wrench
81788	1/2" x 9/16" 40° Deep Offset Box Wrench	81791	15/16" x 1" 40° Deep Offset Box Wrench
81789	11/16" x 3/4" 40° Deep Offset Box Wrench		

GEARWRENCH® 5 Pc. Metric 40° Deep Offset Box Wrench Set

- 40° Deep Offset for Fastener Access
- Made of Premium Alloy Steel
- Bright, Full Polish Chrome Finish
- Surface Drive® on Box End Provides Off-Corner Loading for Better Grip and Reduced Fastener Rounding



Cat. No.	UPC No.	Packaging	Product Weight
81927	099575819278	Boxed	3.52 lb

Cat. No.	Description	Cat. No.	Description
81782	8 x 10mm 40° Deep Offset Box Wrench	81785	12 x 14mm 40° Deep Offset Box Wrench
81783	10 x 12mm 40° Deep Offset Box Wrench	81786	17 x 19mm 40° Deep Offset Box Wrench
81784	11 x 13mm 40° Deep Offset Box Wrench		

GEARWRENCH® 12 Point SAE 40° Deep Offset Box Wrenches

- 40° Deep Offset for Fastener Access
- Made of Premium Alloy Steel
- Bright, Full Polish Chrome Finish
- Surface Drive® on Box End Provides Off-Corner Loading for Better Grip and Reduced Fastener Rounding



Cat. No.	UPC No.	Packaging	End A Fastener Size	End A Width	End B Fastener Size	End B Width	Overall Length	Product Weight
81787	099575817878	Carded	3/8 in	0.640 in	7/16 in	0.724 in	7.677 in	0.19 lb
81788	099575817885	Carded	1/2 in	0.778 in	9/16 in	0.856 in	8.661 in	0.13 lb
81789	099575817892	Carded	11/16 in	1.047 in	3/4 in	1.093 in	9.843 in	0.22 lb
81790	099575817908	Carded	13/16 in	1.211 in	7/8 in	1.309 in	11.417 in	0.32 lb
81791	099575817915	Carded	15/16 in	1.343 in	1 in	1.467 in	14.173 in	0.50 lb

GEARWRENCH® 12 Point Metric 40° Deep Offset Box Wrenches

- 40° Deep Offset for Fastener Access
- Made of Premium Alloy Steel
- Bright, Full Polish Chrome Finish
- Surface Drive® on Box End Provides Off-Corner Loading for Better Grip and Reduced Fastener Rounding



Cat. No.	UPC No.	Packaging	End A Fastener Size	End A Width	End B Fastener Size	End B Width	Overall Length	Product Weight
81782	099575817823	Carded	8 mm	0.561 in	10 mm	0.640 in	7.283 in	0.19 lb
81783	099575817830	Carded	10 mm	0.640 in	12 mm	0.724 in	7.677 in	0.45 lb
81784	099575817847	Carded	11 mm	0.724 in	13 mm	0.817 in	8.071 in	0.97 lb
81785	099575817854	Carded	12 mm	0.778 in	14 mm	0.856 in	8.661 in	1.13 lb
81786	099575817861	Carded	17 mm	1.047 in	19 mm	1.093 in	9.843 in	1.47 lb

GEARWRENCH® 7 Pc. SAE Full Polish Open End Wrench Set

■ Surface Drive Plus™ on Open End: Stronger Grip, Reduces Fastener Rounding, Up to 25% More Torque



SAE

Cat. No.	UPC No.	Packaging	Product Weight
81929	099575819292	Blow Mold Case	3.93 lb

Cat. No.	Description	Cat. No.	Description
81798	1/4" x 5/16" Full Polish Open End Wrench	81803	13/16" x 3/4" Full Polish Open End Wrench
81799	3/8" x 7/16" Full Polish Open End Wrench	81804	15/16" x 1" Full Polish Open End Wrench
81801	1/2" x 9/16" Full Polish Open End Wrench	81805	1-1/8" x 1-1/4" Full Polish Open End Wrench
81802	5/8" x 11/16" Full Polish Open End Wrench		

GEARWRENCH® 6 Pc. Metric Full Polish Open End Wrench Set

■ Surface Drive Plus™ on Open End: Stronger Grip, Reduces Fastener Rounding, Up to 25% More Torque



mm

Cat. No.	UPC No.	Packaging	Product Weight
81928	099575819285	Blow Mold Case	1.24 lb

Cat. No.	Description	Cat. No.	Description
81792	6 x 7mm Full Polish Open End Wrench	81795	11 x 13mm Full Polish Open End Wrench
81793	8 x 10mm Full Polish Open End Wrench	81796	12 x 14mm Full Polish Open End Wrench
81794D	10 x 12mm Full Polish Open End Wrench	81797	17 x 19mm Full Polish Open End Wrench

GEARWRENCH® SAE Full Polish Open End Wrenches

■ Surface Drive Plus™ on Open End: Stronger Grip, Reduces Fastener Rounding, Up to 25% More Torque



SAE

Cat. No.	UPC No.	Packaging	End A Fastener Size	End A Width	End A Thickness	End B Fastener Size	End B Width	End B Thickness	Overall Length	Product Weight
81798	099575817984	Carded	1/4 in	0.494 in	0.130 in	5/16 in	0.658 in	0.146 in	4.882 in	0.06 lb
81799	099575817991	Carded	3/8 in	0.822 in	0.173 in	7/16 in	0.905 in	0.189 in	5.902 in	0.11 lb
81801	099575818011	Carded	1/2 in	1.069 in	0.213 in	9/16 in	1.152 in	0.228 in	6.925 in	0.19 lb
81802	099575818028	Carded	5/8 in	1.316 in	0.252 in	11/16 in	1.399 in	0.268 in	7.945 in	0.14 lb
81803	099575818035	Carded	13/16 in	1.399 in	0.268 in	3/4 in	1.563 in	0.307 in	8.965 in	0.27 lb
81804	099575818042	Carded	15/16 in	1.974 in	0.366 in	1 in	2.057 in	0.382 in	11.008 in	0.44 lb
81805	099575818059	Carded	1-1/8 in	2.468 in	0.445 in	1-1/4 in	2.632 in	0.461 in	12.205 in	0.70 lb

6

WRENCHES

GEARWRENCH® Metric Full Polish Open End Wrenches

- Surface Drive Plus™ on Open End: Stronger Grip, Reduces Fastener Rounding, Up to 25% More Torque



Cat. No.	UPC No.	Packaging	End A Fastener Size	End A Width	End A Thickness	End B Fastener Size	End B Width	End B Thickness	Overall Length	Product Weight
81792	099575817922	Carded	6 mm	0.494 in	0.130 in	7 mm	0.658 in	0.146 in	4.862 in	0.12 lb
81793	099575817939	Carded	8 mm	0.658 in	0.217 in	10 mm	0.822 in	0.217 in	5.882 in	0.13 lb
81794D	099575817946	Carded	10 mm	0.822 in	0.232 in	12 mm	0.988 in	0.232 in	6.390 in	0.15 lb
81795	099575817953	Carded	11 mm	0.905 in	0.244 in	13 mm	1.069 in	0.244 in	6.858 in	0.16 lb
81796	099575817960	Carded	12 mm	0.988 in	0.260 in	14 mm	1.152 in	0.260 in	7.327 in	0.21 lb
81797	099575817977	Carded	17 mm	1.399 in	0.268 in	19 mm	1.563 in	0.307 in	8.917 in	0.39 lb

GEARWRENCH® 3 Pc. Cushion Grip Adjustable Wrench Set

- Cushion Grip for Greater Comfort
- Polished Chrome Head



Cat. No.	UPC No.	Packaging	Product Weight
81990	099575819902	Carded	2.11 lb

Cat. No.	Description	Cat. No.	Description
81890	6" Adjustable Wrench w/Cushion Grip	81892	10" Adjustable Wrench w/Cushion Grip
81891	8" Adjustable Wrench with Cushion Grip		

GEARWRENCH® Cushion Grip Adjustable Wrenches

- Cushion Grip for Greater Comfort
- Wide Capacity Jaw Allows Each Tool to Work with More Fastener Sizes
- Polished Chrome Head



Cat. No.	UPC No.	Packaging	Jaw Capacity	Length	Product Weight
81890	099575818905	Carded	0.750 in	7.000 in	1.30 lb
81891	099575818912	Carded	0.938 in	9.000 in	1.62 lb
81892	099575818929	Carded	1.125 in	11.000 in	1.70 lb
81893	099575818936	Carded	1.312 in	13.000 in	2.70 lb



GEARWRENCH®

Micrometer Torque Wrenches 315

Beam Torque Wrenches 317

Electronic Torque Wrenches 317

GEARWRENCH® Torque Wrenches

GearWrench® torque wrenches offer the latest innovations in torque measurement, including Electronic Torque Wrenches (ETWs). Two GearWrench ETWs include torque angle, ensuring a more precise fastener torque level. GearWrench ETWs show torque ranges in foot-pounds, inch-pounds, or metric torque measurements at the push of a button. Other torque wrenches in the GearWrench line come in drive sizes up to 3/4" with a range of up to 600 foot-pounds.

ELECTRONIC TORQUE WRENCHES WITH ANGLE



Sealed design guards against dirt infiltration

Backlit LCD screen makes reading torque and angle values quick and easy



Digitally tracks torque and angle measurements. Buzzer with Red, Yellow and Green lights alerts you when targets are reached.



Thin-profile, high-strength teardrop head flexes for easier access and features a 60-tooth gear with 6° ratcheting arc

Shock-resistant housing provides durability

Torque Accuracy: +/- 2% CW, +/- 3% CCW from 20% to 100% full scale.
Angle Accuracy: +/- 1% of reading

Knurled aluminum grip resists slipping

MICROMETER TORQUE WRENCHES

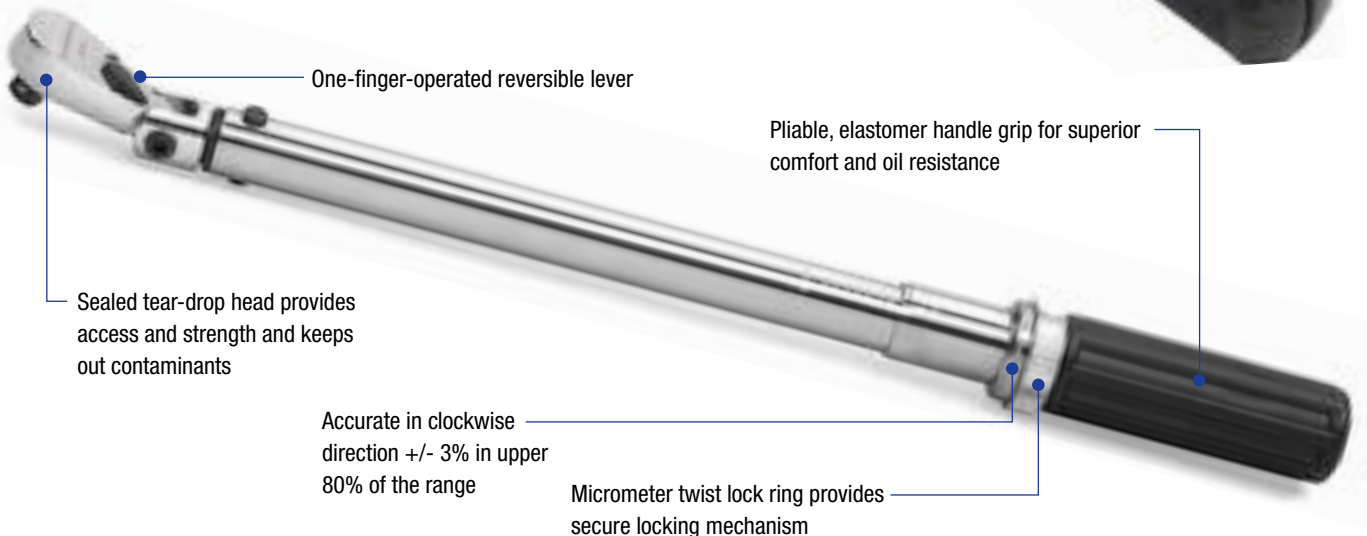

One-finger-operated reversible lever

Sealed tear-drop head provides access and strength and keeps out contaminants

Accurate in clockwise direction +/- 3% in upper 80% of the range

Micrometer twist lock ring provides secure locking mechanism

Pliable, elastomer handle grip for superior comfort and oil resistance

GEARWRENCH® Micrometer Torque Wrenches



- Thin Profile, High-Strength Teardrop Head for Easy Access
- Features a 36-Tooth Gear with a 10° Ratcheting Arc
- Sealed Ratchet Head Design Guards Against Dirt Infiltration
- One-Finger Operated Reversible Lever
- Pliable, Elastomer Handle Grip for Superior Comfort and Oil Resistance
- Micrometer Twist Lock Ring Provides Secure Locking Mechanism
- Accurate in Clockwise Direction +/- 3% in Upper 80% of the Range
- Meets or Exceeds ASME B107.14M 1994

Cat. No.	UPC No.	Drive Tang Size	Primary Scale Range - Max Torque	Primary Scale Increments	Alternate Scale Range - Max Torque	Alt Scale Increments	Head Thickness	Head Width	Overall Length	Product Weight
3261D*	082171032615	1/4 in	5 in/lb - 50 in/lb	1 in/lb	0.58 Nm - 6.2 Nm	0.11 Nm	1.100 in	1.100 in	7.9 in	1.05 lb
85050	082171850509	1/4 in	30 in/lb - 200 in/lb	1 in/lb	3.96 Nm - 23.16 Nm	0.11 Nm	0.813 in	1.063 in	9.5 in	1.28 lb
85051	082171850516	3/8 in	25 in/lb - 250 in/lb	1 in/lb	3.6 Nm - 29.0 Nm	0.11 Nm	0.969 in	1.063 in	9.5 in	2.50 lb
85052	082171850523	3/8 in	10 ft/lb - 100 ft/lb	0.5 ft/lb	16.9 Nm - 138.9 Nm	0.7 Nm	1.063 in	1.500 in	17.1 in	3.20 lb
85053	082171850530	1/2 in	20 ft/lb - 150 ft/lb	1 ft/lb	20.3 Nm - 210.1 Nm	1.4 Nm	1.438 in	1.750 in	20.5 in	4.07 lb
85054	082171850547	1/2 in	20 ft/lb - 250 ft/lb	1 ft/lb	43.4 Nm - 348.4 Nm	1.4 Nm	1.438 in	1.750 in	24 in	4.69 lb

* 3216D is a round head ratchet with 45 tooth gear

GEARWRENCH® 1/2" Drive Micrometer Tire Shop Torque Wrench



- Specifically for Checking Wheel Lug Nuts to Manufacturer Recommended Torque Value
- Helps Prevent the Warpage of Break Rotors Caused By Over Torqueing
- Tough "Tire Tread" Rubber Cover on Head, Lock Ring and Handle Provides Cushioning Effect to Reduce Fatigue and Tool Damage
- 45-Tooth Gear with 8° Ratcheting Arc
- Accurate in Clockwise Direction +/- 3% in Upper 80% of the Range

Cat. No.	UPC No.	Drive Tang Size	Primary Scale Range - Max Torque	Primary Scale Increments	Alternate Scale Range - Max Torque	Alt Scale Increments	Head Thickness	Head Width	Overall Length	Product Weight
3498	082171034985	1/2 in	25 ft/lb - 250 ft/lb	1 ft/lb	47.5 Nm - 345.7 Nm	3.4 Nm	1.75 in	1.75 in	21.38 in	6.06 lb

GEARWRENCH® 3/4" Drive Micrometer Torque Wrenches



- 45-Tooth Gear with 8° Ratcheting Arc
- Accurate in Clockwise Direction +/- 3% in Upper 80% of the Range
- Forward/Reverse Control Dial on the Head
- Pliable, Elastomer Handle Grip for Superior Comfort and Oil Resistance
- Micrometer Twist Lock Ring Provides Secure Locking Mechanism
- Meets or Exceeds ASME B107.14M 1994 and ISO 6789

Cat. No.	UPC No.	Drive Tang Size	Primary Scale Range - Max Torque	Primary Scale Increments	Alternate Scale Range - Max Torque	Alt Scale Increments	Head Thickness	Head Width	Overall Length	Product Weight
85055	082171850554	3/4 in	100 ft/lb - 600 ft/lb	2.5 ft/lb	153 Nm - 830 Nm	3.4 Nm	2.620 in	2.45 in	40.5 in	15.81 lb

GEARWRENCH® Micrometer Torque Wrench, Flex Head Ratcheting



- Thin Profile, High-Strength Teardrop Head for Easy Access, Features a 36-tooth Gear with a 10° Ratcheting Arc
- Sealed Ratchet Head Design Guards Against Dirt Infiltration
- One-Finger Operated Reversible Lever
- Pliable, Elastomer Handle Grip for Superior Comfort and Oil Resistance
- Micrometer Twist Lock Ring Provides Secure Locking Mechanism
- Accurate in Clockwise Direction +/- 3% in Upper 80% of the Range
- Head Flexes up to 15 Degrees for Increased Access

Cat. No.	UPC No.	Drive Tang Size	Primary Scale Range - Max Torque	Primary Scale Increments	Alternate Scale Range - Max Torque	Alt Scale Increments	Head Width	Overall Length	Product Weight
85056	082171850561	3/8 in	5 ft/lb - 75 ft/lb	0.5 ft/lb	6.8 Nm - 101.6 Nm	0.7 Nm	1.50 in	19 in	4.07 lb
85057	082171850578	1/2 in	25 ft/lb - 250 ft/lb	1 ft/lb	43.4 Nm - 348.4 Nm	1.4 Nm	1.750 in	27 in	4.65 lb

GEARWRENCH® Beam Torque Wrenches



- Directly Measure a Variety of Torque Values When Tightening Fasteners
- Pointer Moves Clockwise or Counter-Clockwise (+/-7%) to Measure Torque
- Scale Includes Both SAE (In/Lb, Ft/Lb) and Metric (Nm)
- Serviceable By Bending Pointer to Zero Before Use
- Palm-Fit Handle Pivots on Beam to Maintain Constant Distance From Drive Point to Load Point for Precise Measurement

Cat. No.	UPC No.	Drive Tang Size	Primary Scale Range - Max Torque	Primary Scale Increments	Alternate Scale Range - Max Torque	Alt Scale Increments	Overall Length	Product Weight
2955D	082171029554	1/4 in	0 in/lb - 60 in/lb	2.5 in/lb	0 Nm - 7 Nm	0.25 Nm	11 in	0.8 oz
2956D	082171029561	3/8 in	0 in/lb - 600 in/lb	50 in/lb	0 Nm - 68 Nm	12.00 Nm	16 in	1.0 lb
2957D	082171029578	1/2 in	0 ft/lb - 150 ft/lb	5 ft/lb	0 Nm - 190 Nm	27.00 Nm	20 in	2.5 lb

GEARWRENCH® 1/4" Drive Electronic Torque Wrench



- Perfect for Tire Pressure Systems and Other Sensitive Torque Applications
- Flexible 1/4" Drive Tang
- Red Light and Buzzer Signal Indicate Torque Setting Reached
- Dual Material Cushion Grip Handle

Cat. No.	UPC No.	Drive Tang Size	Primary Scale Range - Max Torque	Primary Scale Increments	Alternate Scale Range - Max Torque	Alt Scale Increments	Head Thickness	Head Width	Overall Length	Product Weight
85072	082171850721	1/4 in	12 in/lb - 120 in/lb	1 in/lb	1.1 Nm - 13.6 Nm	0.25 Nm	1.50 in	0.50 in	10.5 in	1.52 lb

GEARWRENCH® Electronic Torque Wrenches



- Digitally Tracks Torque Measurement. Buzzer with Red, Yellow and Green Lights Alerts You When Target Torque is Reached
- Converts Ft-Lb, In-Lb and Nm at the Touch of A Button
- Thin-Profile, High-Strength Teardrop Head for Easy Access Features a 60-Tooth Gear with a 6° Ratcheting Arc
- Accuracy in Clockwise Direction +/- 2%, in Counter Clockwise Direction +/-3%, From 20% to 100% Full Scale
- Knurled Aluminum Grip Resists Slipping
- Operates on 4 AAA Batteries for Up to 40 Hours of Continuous Operation
- Meets or Exceeds ASME B107.28M

Cat. No.	UPC No.	Drive Tang Size	Primary Scale Range - Max Torque	Primary Scale Increments	Alternate Scale Range - Max Torque	Alt Scale Increments	Head Thickness	Head Width	Overall Length	Product Weight
85070	082171850707	3/8 in	10 ft/lb - 100 ft/lb	1 ft/lb	13.6 Nm - 135.6 Nm	1 Nm	0.960 in	1.240 in	17.75 in	5.20 lb
85071	082171850714	1/2 in	25 ft/lb - 250 ft/lb	1 ft/lb	33.9 Nm - 339 Nm	1 Nm	1.310 in	1.810 in	26.5 in	5.00 lb

GEARWRENCH® Electronic Torque Wrenches, Flex Head with Angle



- Digitally Tracks Torque and Angle Measurements. Buzzer with Red, Yellow and Green Lights Alerts You When Target Torque is Reached
- Converts Ft-Lb, In-Lb and Nm at the Touch of A Button
- Thin-Profile, High-Strength Teardrop Flex Head for Easy Access Features a 60-Tooth Gear with a 6° Ratcheting Arc
- Accuracy in Clockwise Direction +/- 2%, in Counter Clockwise Direction +/-3%, From 20% to 100% Full Scale
- Knurled Aluminum Grip Resists Slipping
- Operates on 4 AAA Batteries for Up to 40 Hours of Continuous Operation
- Meets or Exceeds ASME B107.28M

Cat. No.	UPC No.	Drive Tang Size	Primary Scale Range - Max Torque	Primary Scale Increments	Alternate Scale Range - Max Torque	Alt Scale Increments	Head Thickness	Head Width	Overall Length	Product Weight
85073	082171850738	3/8 in	10 ft/lb - 100 ft/lb	1 ft/lb	13.6 Nm - 135.6 Nm	1 Nm	0.960 in	1.240 in	17.75 in	5.40 lb
85074	082171850745	1/2 in	25 ft/lb - 250 ft/lb	1 ft/lb	33.9 Nm - 339 Nm	1 Nm	1.310 in	1.810 in	26.5 in	5.82 lb

**GEARWRENCH®**

Dual Material Screwdrivers	321
Mini Screwdrivers	327
Solid Handle Screwdrivers.....	329
Insulated Screwdrivers	331
Ratcheting Screwdrivers.....	332
Screwdriver Bit Sets.....	336
Offset Screwdrivers.....	337
Screw Starters.....	337
Ratcheting Nutdrivers	338
Cushion Grip Nutdrivers	339

GEARWRENCH® Screwdrivers

GearWrench® screwdrivers are ergonomically designed to fit your hand when in use. Developed in conjunction with a leading university, the Tri-lobe handle shape offers three sides that provide the best performance with the least amount of effort. A full range of tips and sizes are available in both a Dual Material Comfort Grip and solid Acetate versions. GearWrench® screwdrivers are available individually or in sets.

DUAL MATERIAL SCREWDRIVERS

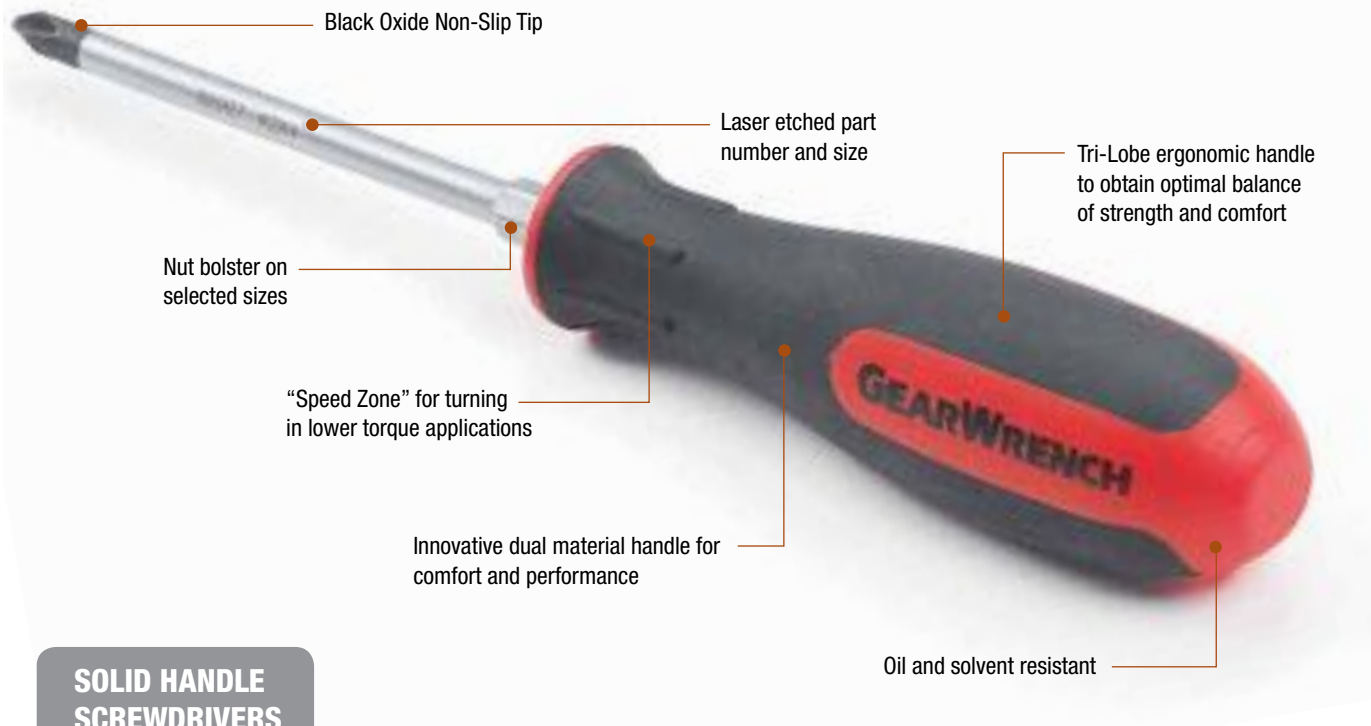

SOLID HANDLE SCREWDRIVERS

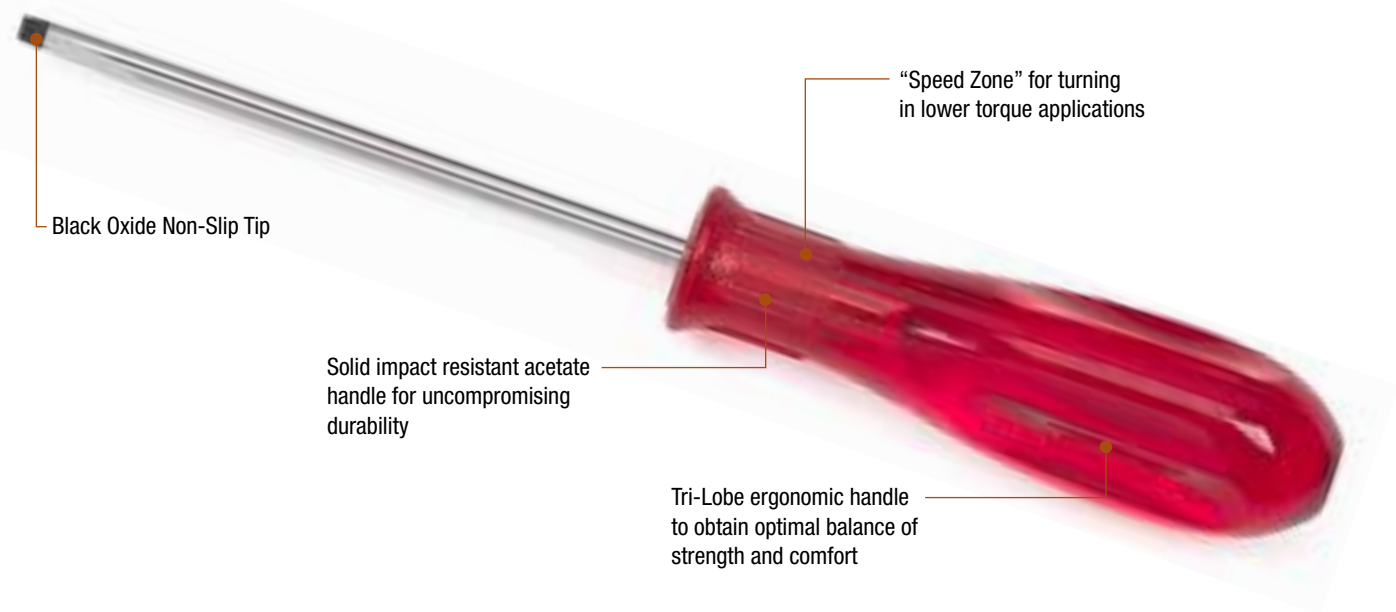

GEARWRENCH® 20 Pc. Master Dual Material Screwdriver Set

- Black Oxide Non-Slip Tip
- Laser Etched Part Number and Size
- Innovative Dual Material Handle for Comfort and Performance
- Oil and Solvent Resistant
- Tri-Lobe Ergonomic Handle to Obtain Optimal Balance of Strength and Comfort
- "Speed Zone" for Turning in Lower Torque Applications
- Meets or Exceeds ASME B107.15



Cat. No.	UPC No.	Packaging	Product Weight
80066	099575800665	Carded	4.51 lb

Cat. No.	Description	Cat. No.	Description
80031	Dual Material Phillips® Screwdriver #00 x 60 mm	80035	Dual Material Slotted Screwdriver 2.0mm x 60 mm
80032	Dual Material Phillips® Screwdriver #0 x 60 mm	80036	Dual Material Slotted Screwdriver 2.5mm x 60 mm
80033	Dual Material Phillips® Screwdriver #1 x 60 mm	80018D	Dual Material Slotted Screwdriver 3/16 x 6"
80000	Dual Material Phillips® Screwdriver #0 x 2-1/2"	80012D	Dual Material Slotted Screwdriver 1/4 x 1-1/2"
80001	Dual Material Phillips® Screwdriver #1 x 3"	80013	Dual Material Slotted Screwdriver 1/4 x 4"
80004	Dual Material Phillips® Screwdriver #1 x 6"	80014	Dual Material Slotted Screwdriver 1/4 x 6"
80005	Dual Material Phillips® Screwdriver #2 x 1-1/2"	80023	Dual Material Slotted Screwdriver 5/16 x 6"
80007	Dual Material Phillips® Screwdriver #2 x 4"	80022	Dual Material Slotted Screwdriver 3/8 x 8"
80011	Dual Material Phillips® Screwdriver #3 x 6"	80025	Dual Material Torx® Screwdriver T-15 x 4"
80034	Dual Material Slotted Screwdriver 1.5mm x 60 mm	80026D	Dual Material Torx® Screwdriver T-20 x 4"

GEARWRENCH® 12 Pc. Combination Dual Material Screwdriver Set

- Black Oxide Non-Slip Tip
- Laser Etched Part Number and Size
- Innovative Dual Material Handle for Comfort and Performance
- Oil and Solvent Resistant
- Tri-Lobe Ergonomic Handle to Obtain Optimal Balance of Strength and Comfort
- "Speed Zone" for Turning in Lower Torque Applications
- Meets or Exceeds ASME B107.15



Cat. No.	UPC No.	Packaging	Product Weight
80051	099575800511	Carded	3.39 lb

Cat. No.	Description	Cat. No.	Description
80000	Dual Material Phillips® Screwdriver #0 x 2-1/2"	80018D	Dual Material Slotted Screwdriver 3/16 x 6"
80001	Dual Material Phillips® Screwdriver #1 x 3"	80012D	Dual Material Slotted Screwdriver 1/4 x 1-1/2"
80004	Dual Material Phillips® Screwdriver #1 x 6"	80013	Dual Material Slotted Screwdriver 1/4 x 4"
80005	Dual Material Phillips® Screwdriver #2 x 1-1/2"	80014	Dual Material Slotted Screwdriver 1/4 x 6"
80007	Dual Material Phillips® Screwdriver #2 x 4"	80023	Dual Material Slotted Screwdriver 5/16 x 6"
80011	Dual Material Phillips® Screwdriver #3 x 6"	80022	Dual Material Slotted Screwdriver 3/8 x 8"

GEARWRENCH® 10 Pc. Combination and Pozidriv® Dual Material Screwdriver Set

- Black Oxide Non-Slip Tip
- Laser Etched Part Number and Size
- Innovative Dual Material Handle for Comfort and Performance
- Oil and Solvent Resistant
- Tri-Lobe Ergonomic Handle to Obtain Optimal Balance of Strength and Comfort
- "Speed Zone" for Turning in Lower Torque Applications
- Meets or Exceeds ASME B107.15



Cat. No.	UPC No.	Packaging	Product Weight
80060	099575800603	Carded	2.20 lb

Cat. No.	Description	Cat. No.	Description
80001	Dual Material Phillips® Screwdriver #1 x 3"	80046	Dual Material Pozidriv® Screwdriver #3 x 6"
80007	Dual Material Phillips® Screwdriver #2 x 4"	80015	Dual Material Slotted Screwdriver 1/8 x 3"
80043	Dual Material Pozidriv® Screwdriver #0 x 2-1/2"	80017	Dual Material Slotted Screwdriver 3/16 x 4"
80044	Dual Material Pozidriv® Screwdriver #1 x 3"	80013	Dual Material Slotted Screwdriver 1/4 x 4"
80045	Dual Material Pozidriv® Screwdriver #2 x 4"	80023	Dual Material Slotted Screwdriver 5/16 x 6"

GEARWRENCH® 6 Pc. Combination Dual Material Screwdriver Set

- Black Oxide Non-Slip Tip
- Laser Etched Part Number and Size
- Innovative Dual Material Handle for Comfort and Performance
- Oil and Solvent Resistant
- Tri-Lobe Ergonomic Handle to Obtain Optimal Balance of Strength and Comfort
- "Speed Zone" for Turning in Lower Torque Applications
- Meets or Exceeds ASME B107.15



Cat. No.	UPC No.	Packaging	Product Weight
80050	099575800504	Carded	1.67 lb

Cat. No.	Description	Cat. No.	Description
80001	Dual Material Phillips® Screwdriver #1 x 3"	80013	Dual Material Slotted Screwdriver 1/4 x 4"
80007	Dual Material Phillips® Screwdriver #2 x 4"	80023	Dual Material Slotted Screwdriver 5/16 x 6"
80015	Dual Material Slotted Screwdriver 1/8 x 3"	80022	Dual Material Slotted Screwdriver 3/8 x 8"

GEARWRENCH® 5 Pc. Slotted Dual Material Screwdriver Set

- Black Oxide Non-Slip Tip
- Laser Etched Part Number and Size
- Innovative Dual Material Handle for Comfort and Performance
- Oil and Solvent Resistant
- Tri-Lobe Ergonomic Handle to Obtain Optimal Balance of Strength and Comfort
- "Speed Zone" for Turning in Lower Torque Applications
- Meets or Exceeds ASME B107.15



Cat. No.	UPC No.	Packaging	Product Weight
80053	099575800535	Carded	1.55 lb

Cat. No.	Description	Cat. No.	Description
80015	Dual Material Slotted Screwdriver 1/8 x 3"	80023	Dual Material Slotted Screwdriver 5/16 x 6"
80013	Dual Material Slotted Screwdriver 1/4 x 4"	80022	Dual Material Slotted Screwdriver 3/8 x 8"
80014	Dual Material Slotted Screwdriver 1/4 x 6"		

GEARWRENCH® 5 Pc. Phillips Dual Material Screwdriver Set

- Black Oxide Non-Slip Tip
- Laser Etched Part Number and Size
- Innovative Dual Material Handle for Comfort and Performance
- Oil and Solvent Resistant
- Tri-Lobe Ergonomic Handle to Obtain Optimal Balance of Strength and Comfort
- "Speed Zone" for Turning in Lower Torque Applications
- Meets or Exceeds ASME B107.15



Cat. No.	UPC No.	Packaging	Product Weight
80052	099575800528	Carded	1.61 lb

Cat. No.	Description	Cat. No.	Description
80000	Dual Material Phillips® Screwdriver #0 x 2-1/2"	80010D	Dual Material Phillips® Screwdriver #2 x 8"
80001	Dual Material Phillips® Screwdriver #1 x 3"	80011	Dual Material Phillips® Screwdriver #3 x 6"
80007	Dual Material Phillips® Screwdriver #2 x 4"		

GEARWRENCH® 4 Pc. Long Combination Dual Material Screwdriver Set

- Black Oxide Non-Slip Tip
- Laser Etched Part Number and Size
- Innovative Dual Material Handle for Comfort and Performance
- Oil and Solvent Resistant
- Tri-Lobe Ergonomic Handle to Obtain Optimal Balance of Strength and Comfort
- "Speed Zone" for Turning in Lower Torque Applications



Cat. No.	UPC No.	Packaging	Product Weight
80059	099575800597	Carded	2.00 lb

Cat. No.	Description	Cat. No.	Description
80006	Dual Material Phillips® Screwdriver #2 x 16"	80021	Dual Material Slotted Screwdriver 3/8 x 16"
80020D	Dual Material Slotted Screwdriver 3/8 x 12"	80019D	Dual Material Slotted Screwdriver 3/16 x 10"

GEARWRENCH® 7 Pc. Torx® Dual Material Screwdriver Set

- Black Oxide Non-Slip Tip
- Laser Etched Part Number and Size
- Innovative Dual Material Handle for Comfort and Performance
- Oil and Solvent Resistant
- Tri-Lobe Ergonomic Handle to Obtain Optimal Balance of Strength and Comfort
- "Speed Zone" for Turning in Lower Torque Applications
- Meets or Exceeds ASME B107.15



Cat. No.	UPC No.	Packaging	Product Weight
80054	099575800542	Carded	1.81 lb

Cat. No.	Description	Cat. No.	Description
80024D	Dual Material Torx® Screwdriver T-10 x 4"	80028D	Dual Material Torx® Screwdriver T-27 x 4"
80025	Dual Material Torx® Screwdriver T-15 x 4"	80029	Dual Material Torx® Screwdriver T-30 x 4"
80026D	Dual Material Torx® Screwdriver T-20 x 4"	80030D	Dual Material Torx® Screwdriver T-40 x 4"
80027	Dual Material Torx® Screwdriver T-25 x 4"		

GEARWRENCH® 3 Pc. Long Torx® Dual Material Screwdriver Set

- Black Oxide Non-Slip Tip
- Laser Etched Part Number and Size
- Innovative Dual Material Handle for Comfort and Performance
- Oil and Solvent Resistant
- Tri-Lobe Ergonomic Handle to Obtain Optimal Balance of Strength and Comfort
- "Speed Zone" for Turning in Lower Torque Applications



Cat. No.	UPC No.	Packaging	Product Weight
80064	099575800641	Carded	3.20 lb

Cat. No.	Description	Cat. No.	Description
80086	Dual Material Torx® Screwdriver T-15 x 18"	80088	Dual Material Torx® Screwdriver T-25 x 18"
80087	Dual Material Torx® Screwdriver T-20 x 18"		

GEARWRENCH® 4 Pc. Pozidriv® Dual Material Screwdriver Set

- Black Oxide Non-Slip Tip
- Laser Etched Part Number and Size
- Innovative Dual Material Handle for Comfort and Performance
- Oil and Solvent Resistant
- Tri-Lobe Ergonomic Handle to Obtain Optimal Balance of Strength and Comfort
- "Speed Zone" for Turning in Lower Torque Applications
- Meets or Exceeds ASME B107.15



Cat. No.	UPC No.	Packaging	Product Weight
80061	099575800610	Carded	1.95 lb

Cat. No.	Description	Cat. No.	Description
80043	Dual Material Pozidriv® Screwdriver #0 x 2-1/2"	80045	Dual Material Pozidriv® Screwdriver #2 x 4"
80044	Dual Material Pozidriv® Screwdriver #1 x 3"	80046	Dual Material Pozidriv® Screwdriver #3 x 6"

GEARWRENCH® 4 Pc. Square Dual Material Screwdriver Set

- Black Oxide Non-Slip Tip
- Laser Etched Part Number and Size
- Innovative Dual Material Handle for Comfort and Performance
- Oil and Solvent Resistant
- Tri-Lobe Ergonomic Handle to Obtain Optimal Balance of Strength and Comfort
- "Speed Zone" for Turning in Lower Torque Applications
- Meets or Exceeds ASME B107.15



Cat. No.	UPC No.	Packaging	Product Weight
80065	099575800658	Carded	1.80 lb

Cat. No.	Description	Cat. No.	Description
80089	Dual Material Square Screwdriver #0 x 4"	80091	Dual Material Square Screwdriver #2 x 4"
80090	Dual Material Square Screwdriver #1 x 4"	80092	Dual Material Square Screwdriver #3 x 5"

GEARWRENCH® Dual Material Screwdrivers - Slotted

- Tri-Lobe Ergonomic Handle to Offer Optimal Balance Power and Comfort
- Dual Material Handle for Comfort and Performance
- "Speed Zone" for Turning in Lower Torque Applications
- Black Oxide Non-Slip Tip
- Magnetic Tip
- Meets or Exceeds ASME B107.15



Cat. No.	UPC No.	Packaging	Tip Thickness	Tip Size	Blade Length	Blade Diameter	Overall Length	Handle Size (Dia. X Length)	Product Weight
80015	099575800153	Carded	0.022 in	1/8 in	4 in	0.117 in	6.227 in	0.89 in x 3.22 in	0.08 lb
80017	099575800177	Carded	0.033 in	3/16 in	4 in	0.196 in	8.125 in	1.15 in x 4.14 in	0.19 lb
80018D	099575800184	Carded	0.033 in	3/16 in	6 in	0.196 in	10.050 in	1.16 in x 4.15 in	0.21 lb
80019D	099575800191	Carded	0.033 in	3/16 in	10 in	0.195 in	14.170 in	1.17 in x 4.15 in	0.22 lb
80012D	099575800122	Carded	0.040 in	1/4 in	1.5 in	0.236 in	4.101 in	1.31 in x 4.61 in	0.12 lb
80013	099575800139	Carded	0.040 in	1/4 in	4 in	0.238 in	8.700 in	1.31 in x 4.61 in	0.22 lb
80014	099575800146	Carded	0.040 in	1/4 in	6 in	0.237 in	10.625 in	1.29 in x 4.62 in	0.25 lb
80023	099575800238	Carded	0.046 in	5/16 in	6 in	0.315 in	13.140 in	1.45 in x 5.13 in	0.42 lb
80022	099575800221	Carded	0.055 in	3/8 in	8 in	0.315 in	13.140 in	1.42 in x 5.12 in	0.46 lb
80020D	099575800207	Carded	0.055 in	3/8 in	12 in	0.315 in	16.950 in	1.44 in x 5.12 in	0.53 lb
80021	099575800214	Carded	0.055 in	3/8 in	16 in	0.315 in	20.900 in	1.45 in x 5.11 in	0.55 lb

GEARWRENCH® Dual Material Screwdrivers - Phillips

- Tri-Lobe Ergonomic Handle to Offer Optimal Balance Power and Comfort
- Dual Material Handle for Comfort and Performance
- "Speed Zone" for Turning in Lower Torque Applications
- Black Oxide Non-Slip Tip
- Magnetic Tip
- Meets or Exceeds ASME B107.15



Cat. No.	UPC No.	Packaging	Tip Size	Blade Length	Blade Diameter	Overall Length	Handle Size (Dia. X Length)	Product Weight
80000	099575800009	Carded	#0	2-1/2 in	0.118 in	5.768 in	0.91 in x 3.26 in	0.07 lb
80001	099575800016	Carded	#1	3 in	0.196 in	7.127 in	1.17 in x 4.15 in	0.15 lb
80004	099575800047	Carded	#1	6 in	0.195 in	10.090 in	1.16 in x 4.16 in	0.16 lb
80005	099575800054	Carded	#2	1-1/2 in	0.236 in	4.094 in	1.31 in x 2.56 in	0.12 lb
80007	099575800078	Carded	#2	4 in	0.237 in	8.700 in	1.29 in x 4.62 in	0.26 lb
80009	099575800092	Carded	#2	6 in	0.237 in	10.675 in	1.28 in x 4.60 in	0.25 lb
80010D	099575800108	Carded	#2	8 in	0.235 in	12.500 in	1.28 in x 4.62 in	0.28 lb
80006	099575800160	Carded	#2	16 in	0.236 in	20.400 in	1.29 in x 4.62 in	0.44 lb
80011	099575800115	Carded	#3	6 in	0.315 in	11.200 in	1.45 in x 5.12 in	0.41 lb

GEARWRENCH® Dual Material Screwdrivers - Torx®

- Tri-Lobe Ergonomic Handle to Offer Optimal Balance Power and Comfort
- Dual Material Handle for Comfort and Performance
- "Speed Zone" for Turning in Lower Torque Applications
- Black Oxide Non-Slip Tip
- Magnetic Tip
- Meets or Exceeds ASME B107.15



Cat. No.	UPC No.	Packaging	Tip Size	Blade Length	Blade Diameter	Overall Length	Handle Size (Dia. X Length)	Product Weight
80024D	099575800245	Carded	T10	4 in	0.196 in	8.100 in	1.15 in x 4.14 in	0.16 lb
80025	099575800252	Carded	T15	4 in	0.196 in	8.100 in	1.16 in x 4.14 in	0.16 lb
80086	099575800863	Carded	T15	18 in	0.195 in	22.000 in	1.14 in x 4.14 in	0.45 lb
80026D	099575800269	Carded	T20	4 in	0.196 in	8.100 in	1.16 in x 4.15 in	0.16 lb
80087	099575800870	Carded	T20	18 in	0.195 in	22.000 in	1.17 in x 4.14 in	0.45 lb
80027	099575800276	Carded	T25	4 in	0.235 in	8.600 in	1.30 in x 4.61 in	0.22 lb
80088	099575800887	Carded	T25	18 in	0.235 in	22.000 in	1.30 in x 4.60 in	0.60 lb
80028D	099575800283	Carded	T27	4 in	0.235 in	8.600 in	1.30 in x 4.61 in	0.22 lb
80029	099575800290	Carded	T30	4 in	0.235 in	8.600 in	1.30 in x 4.61 in	0.22 lb

GEARWRENCH® Dual Material Screwdrivers - Pozidriv®

- Tri-Lobe Ergonomic Handle to Offer Optimal Balance Power and Comfort
- Dual Material Handle for Comfort and Performance
- "Speed Zone" for Turning in Lower Torque Applications
- Black Oxide Non-Slip Tip
- Magnetic Tip
- Meets or Exceeds ASME B107.15



Cat. No.	UPC No.	Packaging	Tip Size	Blade Length	Blade Diameter	Overall Length	Handle Size (Dia. X Length)	Product Weight
80043	099575800436	Carded	#0	2-1/2 in	0.118 in	5.757 in	0.89 in x 3.24 in	0.08 lb
80044	099575080043	Carded	#1	3 in	0.196 in	7.167 in	1.17 in x 4.15 in	0.15 lb
80045	099575800450	Carded	#2	4 in	0.237 in	8.550 in	1.30 in x 4.62 in	0.22 lb
80046	099575800467	Carded	#3	6 in	0.315 in	11.050 in	1.42 in x 5.11 in	0.36 lb

GEARWRENCH® Dual Material Screwdrivers - Square

- Tri-Lobe Ergonomic Handle to Offer Optimal Balance Power and Comfort
- Dual Material Handle for Comfort and Performance
- "Speed Zone" for Turning in Lower Torque Applications
- Black Oxide Non-Slip Tip
- Magnetic Tip
- Meets or Exceeds ASME B107.15



Cat. No.	UPC No.	Packaging	Tip Size	Blade Length	Blade Diameter	Overall Length	Handle Size (Dia. X Length)	Product Weight
80089	099575800894	Carded	#0	4 in	0.196 in	8.100 in	1.17 in x 4.14 in	0.30 lb
80090	099575800900	Carded	#1	4 in	0.235 in	8.575 in	1.28 in x 4.60 in	0.30 lb
80091	099575800917	Carded	#2	4 in	0.235 in	8.575 in	1.30 in x 4.60 in	0.35 lb
80092	099575800924	Carded	#3	5 in	0.315 in	10.050 in	1.45 in x 5.12 in	0.35 lb

GEARWRENCH® 12 Pc. Combination Mini Dual Material Screwdriver Set

- Cap Color Indicates Tip Style
- Innovative Dual Material Handle for Comfort and Performance
- Black Oxide Non-Slip Tip
- "Speed Zone" for Turning in Lower Torque Applications
- Tri-Lobe Ergonomic Handle to Offer Optimal Balance Power and Comfort



Cat. No.	UPC No.	Packaging	Product Weight
80057	099575800573	Carded	1.17 lb

Cat. No.	Description	Cat. No.	Description
80031	Dual Material Phillips® Screwdriver #00 x 60 mm	80037	Dual Material Torx® Screwdriver T-5 x 60 mm
80032	Dual Material Phillips® Screwdriver #0 x 60 mm	80038	Dual Material Torx® Screwdriver T-6 x 60 mm
80033	Dual Material Phillips® Screwdriver #1 x 60 mm	80039	Dual Material Torx® Screwdriver T-7 x 60 mm
80034	Dual Material Slotted Screwdriver 1.5mm x 60 mm	80040	Dual Material Torx® Screwdriver T-8 x 60 mm
80035	Dual Material Slotted Screwdriver 2.0mm x 60 mm	80041	Dual Material Torx® Screwdriver T-9 x 60 mm
80036	Dual Material Slotted Screwdriver 2.5mm x 60 mm	80042D	Dual Material Torx® Screwdriver T-10 x 60 mm

GEARWRENCH® 6 Pc. Mini Dual Material Screwdriver Set

- Cap Color Indicates Tip Style
- Innovative Dual Material Handle for Comfort and Performance
- Black Oxide Non-Slip Tip
- "Speed Zone" for Turning in Lower Torque Applications
- Tri-Lobe Ergonomic Handle to Offer Optimal Balance Power and Comfort



Cat. No.	UPC No.	Packaging	Product Weight
80055	099575800559	Carded	0.84 lb

Cat. No.	Description	Cat. No.	Description
80031	Dual Material Phillips® Screwdriver #00 x 60 mm	80034	Dual Material Slotted Screwdriver 1.5mm x 60 mm
80032	Dual Material Phillips® Screwdriver #0 x 60 mm	80035	Dual Material Slotted Screwdriver 2.0mm x 60 mm
80033	Dual Material Phillips® Screwdriver #1 x 60 mm	80036	Dual Material Slotted Screwdriver 2.5mm x 60 mm

GEARWRENCH® 6 Pc. Mini Torx® Dual Material Screwdriver Set

- Cap Color Indicates Tip Style
- Innovative Dual Material Handle for Comfort and Performance
- Black Oxide Non-Slip Tip
- "Speed Zone" for Turning in Lower Torque Applications
- Tri-Lobe Ergonomic Handle to Offer Optimal Balance Power and Comfort

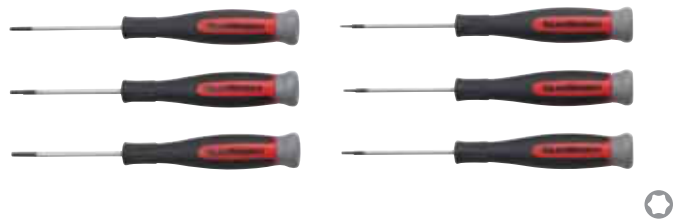

Cat. No.	UPC No.	Packaging	Product Weight
80056	099575800566	Carded	0.84 lb

Cat. No.	Description	Cat. No.	Description
80037	Dual Material Torx® Screwdriver T-5 x 60 mm	80040	Dual Material Torx® Screwdriver T-8 x 60 mm
80038	Dual Material Torx® Screwdriver T-6 x 60 mm	80041	Dual Material Torx® Screwdriver T-9 x 60 mm
80039	Dual Material Torx® Screwdriver T-7 x 60 mm	80042D	Dual Material Torx® Screwdriver T-10 x 60 mm

GEARWRENCH® Mini Dual Material Screwdrivers - Slotted

- Tri-Lobe Ergonomic Handle to Offer Optimal Balance Power and Comfort
- Dual Material Handle for Comfort and Performance
- "Speed Zone" for Turning in Lower Torque Applications
- Black Oxide Non-Slip Tip
- Meets or Exceeds ASME B107.15



Cat. No.	UPC No.	Packaging	Tip Size	Blade Length	Blade Diameter	Overall Length	Handle Size (Dia. X Length)	Product Weight
80034	099575800344	Carded	1.5mm	60 mm	0.097 in	6.110 in	0.75 in x 3.71 in	0.06 lb
80035	099575800351	Carded	2.0mm	60 mm	0.097 in	6.111 in	0.75 in x 3.71 in	0.06 lb
80036	099575800368	Carded	2.5mm	60 mm	0.098 in	6.118 in	0.75 in x 3.71 in	0.06 lb

GEARWRENCH® Mini Dual Material Screwdrivers - Phillips

- Tri-Lobe Ergonomic Handle to Offer Optimal Balance Power and Comfort
- Dual Material Handle for Comfort and Performance
- "Speed Zone" for Turning in Lower Torque Applications
- Black Oxide Non-Slip Tip
- Meets or Exceeds ASME B107.15



Cat. No.	UPC No.	Packaging	Tip Size	Blade Length	Blade Diameter	Overall Length	Handle Size (Dia. X Length)	Product Weight
80031	099575800313	Carded	#00	60 mm	0.098 in	6.116 in	0.74 in x 3.70 in	0.06 lb
80032	099575800320	Carded	#0	60 mm	0.118 in	6.109 in	0.75 in x 3.71 in	0.06 lb
80033	099575800337	Carded	#1	60 mm	0.157 in	6.106 in	0.75 in x 3.71 in	0.06 lb

GEARWRENCH® Mini Dual Material Screwdrivers - Torx®

- Tri-Lobe Ergonomic Handle to Offer Optimal Balance Power and Comfort
- Dual Material Handle for Comfort and Performance
- "Speed Zone" for Turning in Lower Torque Applications
- Black Oxide Non-Slip Tip
- Meets or Exceeds ASME B107.15



Cat. No.	UPC No.	Packaging	Tip Size	Blade Length	Blade Diameter	Overall Length	Handle Size (Dia. X Length)	Product Weight
80037	099575800375	Carded	T5	60 mm	0.098 in	6.084 in	0.75 in x 3.71 in	0.06 lb
80038	099575800382	Carded	T6	60 mm	0.098 in	6.083 in	0.75 in x 3.71 in	0.06 lb
80039	099575800399	Carded	T7	60 mm	0.098 in	6.087 in	0.75 in x 3.71 in	0.06 lb
80040	099575800405	Carded	T8	60 mm	0.097 in	6.084 in	0.75 in x 3.71 in	0.06 lb
80041	099575800443	Carded	T9	60 mm	0.117 in	6.084 in	0.75 in x 3.71 in	0.06 lb
80042D	099575804205	Carded	T10	60 mm	0.117 in	6.083 in	0.75 in x 3.71 in	0.06 lb

GEARWRENCH® 8 Pc. Combination Solid Handle Screwdriver Set

- Black Oxide Non-Slip Tip
- Solid 100% Impact Resistant Acetate Handle
- Tri-Lobe Ergonomic Handle to Obtain Optimal Balance of Strength and Comfort
- "Speed Zone" for Turning in Lower Torque Applications
- Meets or Exceeds ASME B107.15



Cat. No.	UPC No.	Packaging	Product Weight
82734	099575827341	Carded	1.31 lb

Cat. No.	Description	Cat. No.	Description
82700	Acetate Slotted Screwdriver 1/8" x 2"	82713	Acetate Phillips® Screwdriver #0 x 2-1/2"
82701	Acetate Cabinet Screwdriver 1/8" x 4"	82715	Acetate Phillips® Screwdriver #1 x 3"
82702	Acetate Slotted Screwdriver 3/16" x 6"	82717	Acetate Phillips® Screwdriver #2 x 4"
82706	Acetate Slotted Screwdriver 1/4" x 4"	82718	Acetate Phillips® Screwdriver #2 x 6"

GEARWRENCH® Solid Handle Square Shank Screwdrivers - Slotted

- Tri-Lobe Ergonomic Handle to Offer Optimal Balance Power and Comfort
- Solid Impact Resistant Acetate Handle
- "Speed Zone" for Fast Turning and Control in Lower Torque Applications
- Black Oxide Non-Slip Tip
- Meets or Exceeds ASME B107.15



Cat. No.	UPC No.	Packaging	Tip Thickness	Tip Size	Blade Length	Blade Diameter	Overall Length	Handle Size (Dia. X Length)	Product Weight
82700	099575827006	Carded	0.03 in	1/8 in	2 in	0.118 in	4.800 in	0.86 in x 2.76 in	0.06 lb
82704	099575827044	Carded	0.03 in	3/16 in	4 in	0.197 in	8.000 in	1.22 in x 3.94 in	0.19 lb
82702	099575827020	Carded	0.03 in	3/16 in	6 in	0.197 in	10.000 in	1.22 in x 3.94 in	0.20 lb
82706	099575827068	Carded	0.04 in	1/4 in	4 in	0.236 in	8.400 in	1.34 in x 4.33 in	0.24 lb
82707	099575827075	Carded	0.04 in	1/4 in	6 in	0.236 in	10.400 in	1.34 in x 4.33 in	0.27 lb
82703	099575827037	Carded	0.05 in	5/16 in	6 in	0.315 in	10.800 in	1.47 in x 4.72 in	0.40 lb
82708	099575827082	Carded	0.06 in	3/8 in	8 in	0.315 in	12.800 in	1.47 in x 4.72 in	0.51 lb
82710	099575827105	Carded	0.06 in	3/8 in	12 in	0.315 in	16.800 in	1.47 in x 4.72 in	0.71 lb

GEARWRENCH® Solid Handle Screwdrivers - Cabinet Tip

- Tri-Lobe Ergonomic Handle to Offer Optimal Balance Power and Comfort
- Solid Impact Resistant Acetate Handle
- "Speed Zone" for Fast Turning and Control in Lower Torque Applications
- Black Oxide Non-Slip Tip
- Meets or Exceeds ASME B107.15



Cat. No.	UPC No.	Packaging	Tip Thickness	Tip Size	Blade Length	Blade Diameter	Overall Length	Handle Size (Dia. X Length)	Product Weight
82701	099575827013	Carded	0.022 in	1/8 in	4 in	0.118 in	6.800 in	0.86 in x 2.76 in	0.08 lb

GEARWRENCH® Solid Handle Screwdrivers - Phillips

- Tri-Lobe Ergonomic Handle to Offer Optimal Balance Power and Comfort
- Solid Impact Resistant Acetate Handle
- "Speed Zone" for Fast Turning and Control in Lower Torque Applications
- Black Oxide Non-Slip Tip
- Meets or Exceeds ASME B107.15



Cat. No.	UPC No.	Packaging	Tip Size	Blade Length	Blade Diameter	Overall Length	Handle Size (Dia. X Length)	Product Weight
82713	099575827136	Carded	#0	2-1/2 in	0.118 in	5.320 in	0.86 in x 2.76 in	0.07 lb
82715	099575827150	Carded	#1	3 in	0.197 in	7.000 in	1.22 in x 3.94 in	0.15 lb
82717	099575827174	Carded	#2	4 in	0.236 in	8.400 in	1.34 in x 4.33 in	0.23 lb
82718	099575827181	Carded	#2	6 in	0.236 in	10.400 in	1.34 in x 4.33 in	0.25 lb
82720	099575827204	Carded	#3	6 in	0.315 in	10.800 in	1.47 in x 4.72 in	0.37 lb

GEARWRENCH® 7 Pc. Insulated Screwdriver Set

- Rated to 1,000 Volts
- Certified to IEC 60900:2004 Standard
- Dual Material Grip for Comfort and Performance
- Black Oxide Non-Slip Tip



Cat. No.	UPC No.	Packaging	Product Weight
80063	099575800634	Carded	1.85 lb

Cat. No.	Description	Cat. No.	Description
80083	Insulated Phillips® Screwdriver #0 x 2-1/2"	80048	Insulated Slotted Screwdriver 5/32" x 4"
80081	Insulated Phillips® Screwdriver #1 x 3-1/8"	80049	Insulated Slotted Screwdriver 7/32" x 5"
80082	Insulated Phillips® Screwdriver #2 x 4"	80080	Insulated Slotted Screwdriver 1/4" x 6"
80047	Insulated Slotted Screwdriver 3/32" x 3"		

GEARWRENCH® Insulated Screwdrivers - Slotted

- Rated to 1,000 Volts
- Certified to IEC 60900:2004 Standard
- Dual Material Grip for Comfort and Performance
- Black Oxide Non-Slip Tip



Cat. No.	UPC No.	Packaging	Tip Thickness	Tip Size	Blade Length	Blade Diameter	Overall Length	Handle Size (Dia. X Length)	Product Weight
80047	099575080074	Carded	0.016 in	3/32 in	3 in	0.169 in	5.783 in	0.87 in x 2.80 in	0.07 lb
80048	099575800481	Carded	0.027 in	5/32 in	4 in	0.229 in	7.541 in	1.12 in x 3.59 in	0.19 lb
80049	099575800498	Carded	0.035 in	7/32 in	5 in	0.288 in	8.95 in	1.27 in x 4.00 in	0.17 lb
80080	099575800801	Carded	0.04 in	1/4 in	6 in	0.33 in	9.925 in	1.27 in x 4.05 in	0.18 lb

GEARWRENCH® Insulated Screwdrivers - Phillips

- Rated to 1,000 Volts
- Certified to IEC 60900:2004 Standard
- Dual Material Grip for Comfort and Performance
- Black Oxide Non-Slip Tip



Cat. No.	UPC No.	Packaging	Tip Size	Blade Length	Blade Diameter	Overall Length	Handle Size (Dia. X Length)	Product Weight
80083	099575800832	Carded	#0	2-1/2 in	0.189 in	5.194 in	0.88 in x 2.83 in	0.14 lb
80081	099575800818	Carded	#1	3-1/8 in	0.255 in	6.752 in	1.12 in x 3.60 in	0.16 lb
80082	099575800825	Carded	#2	4 in	0.308 in	7.95 in	1.27 in x 4.03 in	0.17 lb

GEARWRENCH® Insulated Screwdrivers - Pozidriv

- Rated to 1,000 Volts
- Certified to IEC 60900:2004 Standard
- Dual Material Grip for Comfort and Performance
- Black Oxide Non-Slip Tip



Cat. No.	UPC No.	Packaging	Tip Size	Blade Length	Blade Diameter	Overall Length	Handle Size (Dia. X Length)	Product Weight
80084	099575800849	Carded	#1	3-1/8 in	0.254 in	6.755 in	1.14 in x 3.60 in	0.15 lb
80085D	099575800856	Carded	#2	4 in	0.307 in	7.541 in	1.28 in x 4.03 in	0.17 lb

GEARWRENCH® 40 Pc. Ratcheting Screwdriver Set

- Precision, Fine Tooth, Reversible Ratcheting Mechanism
- Includes A Straight Handle, Stubby Handle, and T-Handle
- Flexible and Solid Drive Shafts
- Premium S2 Quality Steel Bits
- Contoured, Dual Material Comfort Grip
- Oil and Solvent Resistant



Cat. No.	UPC No.	Packaging	Product Weight
8940	082171089404	Boxed	4.14 lb

Cat. No.	Description	Cat. No.	Description	Cat. No.	Description
890001GD	Ratcheting Screwdriver Straight Handle 1/4" Drive	-	#3 Phillips Bit	-	7/32" Slotted Bit
890006GD	Ratcheting Screwdriver T-Handle 1/4" Drive	-	1/8" Hex Bit	-	1/4" Slotted Bit
890005GD	Ratcheting Screwdriver Stubby Handle 1/4" Drive	-	5/32" Hex Bit	-	4mm Slotted Bit
890007GD	Shaft Adapter 1/4" to 1/4"	-	3/16" Hex Bit	-	5.5mm Slotted Bit
890008GD	11" 1/4" Shank 180° Flex Bit Shaft	-	7/32" Hex Bit	-	6.5mm Slotted Bit
890009GD	11" 1/4" Shank 180° Flex Socket Shaft	-	1/4" Hex Bit	-	T-8 Torx® Bit
310901GR	Magnetic Bit Shaft 1/4 Shank x 3-1/2"	-	5/16" Hex Bit	-	T-10 Torx® Bit
310902GR	Magnetic Bit Shaft 1/4 Shank x 6"	-	3mm Hex Bit	-	T-15 Torx® Bit
311901GR	Socket Shaft 1/4 Shank x 3-1/2"	-	4mm Hex Bit	-	T-20 Torx® Bit
311902GR	Socket Shaft 1/4 Shank x 6"	-	5mm Hex Bit	-	T-25 Torx® Bit
890003GD	30 Pc. Bit Set in Box	-	6mm Hex Bit	-	T-27 Torx® Bit
-	#0 Phillips Bit	-	7mm Hex Bit	-	T-30 Torx® Bit
-	#1 Phillips Bit	-	8mm Hex Bit	-	T-40 Torx® Bit
-	#2 Phillips Bit	-	5/32" Slotted Bit	-	

GEARWRENCH® 39 Pc. Ratcheting Screwdriver Set

- Precision, Fine Tooth, Reversible Ratcheting Mechanism
- Premium S2 Quality Steel Bits
- Flexible and Solid Drive Shafts
- Contoured, Dual Material Comfort Grip
- Oil and Solvent Resistant



Cat. No.	UPC No.	Packaging	Product Weight
8939	082171089398	Boxed	3.00 lb

Cat. No.	Description	Cat. No.	Description	Cat. No.	Description
890001GD	Ratcheting Screwdriver Straight Handle 1/4" Drive	-	1/8" Hex Bit	-	1/4" Slotted Bit
890002GD	1/4" Hex Shank Bit Adapter Hex Bit Adapter	-	5/32" Hex Bit	-	4mm Slotted Bit
311904GR	Socket Shaft 1/4 Shank x 10"	-	3/16" Hex Bit	-	5.5mm Slotted Bit
310901GR	Magnetic Bit Shaft 1/4 Shank x 3-1/2"	-	7/32" Hex Bit	-	6.5mm Slotted Bit
310902GR	Magnetic Bit Shaft 1/4 Shank x 6"	-	1/4" Hex Bit	-	T-8 Torx® Bit
310903GR	Magnetic Bit Shaft 1/4 Shank x 10"	-	5/16" Hex Bit	-	T-10 Torx® Bit
311901GR	Socket Shaft 1/4 Shank x 3-1/2"	-	3mm Hex Bit	-	T-15 Torx® Bit
311902GR	Socket Shaft 1/4 Shank x 6"	-	4mm Hex Bit	-	T-20 Torx® Bit
311903GR	Flexible Socket Shaft 1/4 Shank x 6"	-	5mm Hex Bit	-	T-25 Torx® Bit
890003GD	30 Pc. Bit Set in Box	-	6mm Hex Bit	-	T-27 Torx® Bit
-	#0 Phillips Bit	-	7mm Hex Bit	-	T-30 Torx® Bit
-	#1 Phillips Bit	-	8mm Hex Bit	-	T-40 Torx® Bit
-	#2 Phillips Bit	-	5/32" Slotted Bit	-	
-	#3 Phillips Bit	-	7/32" Slotted Bit	-	

GEARWRENCH® 26 Pc. Ratcheting Screwdriver Set

- Precision, Fine Tooth, Reversible Ratcheting Mechanism
- Premium S2 Quality Steel Bits
- Flexible and Solid Drive Shafts
- Contoured, Dual Material Comfort Grip
- Oil and Solvent Resistant



Cat. No.	UPC No.	Packaging	Product Weight
8926D	082171089268	Boxed	2.39 lb

Cat. No.	Description	Qty.	Cat. No.	Description	Qty.	Cat. No.	Description	Qty.
890001GD	Ratcheting Screwdriver Straight Handle 1/4" Drive	1	-	#3 Phillips Bit	1	-	3/16" Slotted Bit	1
890002GD	1/4" Hex Shank Bit Adapter Hex Bit Adapter	1	-	3/32" Hex Bit	1	-	1/4" Slotted Bit	2
311901GR	Socket Shaft 1/4 Shank x 3-1/2"	1	-	1/8" Hex Bit	1	-	T-10 Torx® Bit	1
311902GR	Socket Shaft 1/4 Shank x 6"	1	-	5/32" Hex Bit	1	-	T-15 Torx® Bit	1
311903GR	Flexible Socket Shaft 1/4 Shank x 6"	1	-	3/16" Hex Bit	1	-	T-20 Torx® Bit	1
311904GR	Socket Shaft 1/4 Shank x 10"	1	-	1/4" Hex Bit	1	-	T-25 Torx® Bit	1
-	#1 Phillips Bit	1	-	5/16" Hex Bit	1	-	T-30 Torx® Bit	1
-	#2 Phillips Bit	2	-	5/32" Slotted Bit	1	-	T-40 Torx® Bit	1

GEARWRENCH® 7 Pc. Ratcheting GearDriver® Set

- Precision, Fine Tooth, Reversible Ratcheting Mechanism
- Premium S2 Quality Steel Bits
- Contoured, Dual Material Comfort Grip
- Oil and Solvent Resistant



Cat. No.	UPC No.	Packaging	Product Weight
82781	099575827815	Carded	0.83 lb

Cat. No.	Description	Cat. No.	Description
-	#0 Phillips Bit	-	5/32" Slotted Bit
-	#1 Phillips Bit	-	3/16" Slotted Bit
-	#2 Phillips Bit	-	1/4" Slotted Bit

GEARWRENCH® Ratcheting Screwdriver Handles and Shafts



Cat. No.	UPC No.	Packaging	Description	Product Weight
310901GR	082171000904	Carded	Magnetic Bit Shaft 1/4 Shank x 3-1/2"	0.09 lb
310902GR	0821710009020	Carded	Magnetic Bit Shaft 1/4 Shank x 6"	0.14 lb
310903GR	082171109034	Carded	Magnetic Bit Shaft 1/4 Shank x 10"	0.18 lb
311901GR	082171019012	Carded	Socket Shaft 1/4 Shank x 3-1/2"	0.08 lb
311902GR	082171019029	Carded	Socket Shaft 1/4 Shank x 6"	0.14 lb
311903GR	082171119033	Carded	Flexible Socket Shaft 1/4 Shank x 6"	0.14 lb
311904GR	082171311901	Carded	Socket Shaft 1/4 Shank x 10"	1.60 lb
890001GD	082171900013	Carded	Ratcheting Screwdriver Straight Handle 1/4" Drive	0.36 lb
890005GD	082171900051	Carded	Ratcheting Screwdriver Stubby Handle 1/4" Drive	0.26 lb
890006GD	082171900068	Carded	Ratcheting Screwdriver T-Handle 1/4" Drive	0.31 lb

GEARWRENCH® Adapters

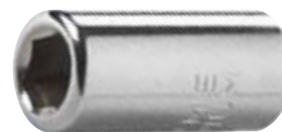

Cat. No.	UPC No.	Packaging	Description	Product Weight
312901GD	082171312908	Carded	Adapter for 13mm Vortex® Socket	0.04 lb
890002GD	082171890000	Carded	1/4" Hex Shank Bit Adapter Hex Bit Adapter	0.03 lb
890007GD	082171900075	Carded	Shaft Adapter 1/4" to 1/4"	0.05 lb

GEARWRENCH® 2-Position Ratcheting Screwdriver with LED Lights

- 45-Tooth Ratcheting Mechanism with Forward, Reverse and Lock Positions
- 2-Position Handle - Straight or Pistol Grip
- 2 LED Lights to Illuminate Work Area
- 4-1/2" Shaft Provides Access
- Stainless Steel Collar Magnetises Bit Tip to Hold Screw
- Storage for 6 Bits in Handle
- Requires (3) 1.5V Batteries, Included
- Phillips Bits #1, #2
- Star Bits T-15, T-20, T-25, T-27



Cat. No.	UPC No.	Product Weight
82788	099575827884	0.77 lb

GEARWRENCH® 6-in-1 Cushion Grip Screwdriver

- Ergonomic Cushion Grip for Reduced Hand Fatigue and Greater Comfort
- Quick Change Nutdriver Shank
- Slotted 1/4" X Phillips® #2
- Slotted 3/16" X Phillips® #1



Cat. No.	UPC No.	Packaging	Product Weight
82782	099575827822	Retail Packaging	0.80 lb

GEARWRENCH® Magnetic Bit Holding Screwdriver

- Tri-Lobe Ergonomic Handle to Obtain Optimal Balance of Strength and Comfort
- "Speed Zone" for Turning in Lower Torque Applications
- Oil and Solvent Resistant
- Innovative Dual Material Handle for Comfort and Performance
- For Standard 1/4" Drive Bits



Cat. No.	UPC No.	Packaging	Tip Size	Overall Length	Product Weight
82783	099575827839	Carded	1/4 in	10.75 in	0.27 lb

GEARWRENCH® 83 Pc. Screwdriver Accessory Set

- Large Assortment of Premium S2 Steel Screwdriver and Nutdriver Bits
- Includes a 1/4" Bit Holder and a Storage Case
- Multiple Quantities on Some Sizes Listed Below Due to Varying Lengths



Cat. No.	UPC No.	Packaging		Product Weight	
82784	099575827846	Boxed		2.12 lb	

Cat. No.	Description	Qty.	Cat. No.	Description	Qty.	Cat. No.	Description	Qty.
-	1/4" Bit Holder	1	-	5/32" Nutdriver Bit	1	-	T-20 Torx® Bit	3
-	#0 Phillips Bit	1	-	3/16" Nutdriver Bit	1	-	T-25 Torx® Bit	3
-	#1 Phillips Bit	2	-	1/4" Nutdriver Bit	1	-	T-27 Torx® Bit	2
-	#2 Phillips Bit	5	-	9/32" Nutdriver Bit	1	-	T-30 Torx® Bit	2
-	#3 Phillips Bit	4	-	5/16" Nutdriver Bit	1	-	T-40 Torx® Bit	2
-	#2 Pozidriv® Bit	2	-	11/32" Nutdriver Bit	1	-	T-7 Tamper-proof Torx® Bit	1
-	#3 Pozidriv® Bit	3	-	3/8" Nutdriver Bit	1	-	T-8 Tamper-proof Torx® Bit	1
-	#2 Square Bit	3	-	7/16" Nutdriver Bit	1	-	T-10 Tamper-proof Torx® Bit	1
-	#3 Square Bit	3	-	6 - 8 Slotted Bit	3	-	T-15 Tamper-proof Torx® Bit	1
-	5/32" Hex Bit	3	-	8 - 10 Slotted Bit	5	-	T-20 Tamper-proof Torx® Bit	1
-	3/16" Hex Bit	2	-	10 - 12 Slotted Bit	4	-	T-25 Tamper-proof Torx® Bit	1
-	7/32" Hex Bit	2	-	12 - 14 Slotted Bit	3	-	T-27 Tamper-proof Torx® Bit	1
-	1/4" Hex Bit	2	-	T-10 Torx® Bit	2	-	T-30 Tamper-proof Torx® Bit	1
-	5/16" Hex Bit	2	-	T-15 Torx® Bit	3	-		

GEARWRENCH® 31 Pc. Bit Set with Adapter in Box

- Premium S2 Quality Steel Bits
- 1/4" Drive to Bit Drive Adapter



Cat. No.	UPC No.	Packaging	Product Weight
890004GD	082171890048	Bagged	0.85 lb

Cat. No.	Description	Cat. No.	Description	Cat. No.	Description	Cat. No.	Description
-	1/4" Bit Holder	-	4mm Hex Bit	-	4mm Slotted Bit	-	T-10 Torx® Bit
-	1/8" Hex Bit	-	5mm Hex Bit	-	5.5mm Slotted Bit	-	T-15 Torx® Bit
-	5/32" Hex Bit	-	6mm Hex Bit	-	6.5mm Slotted Bit	-	T-20 Torx® Bit
-	3/16" Hex Bit	-	7mm Hex Bit	-	#0 Phillips Bit	-	T-25 Torx® Bit
-	7/32" Hex Bit	-	8mm Hex Bit	-	#1 Phillips Bit	-	T-27 Torx® Bit
-	1/4" Hex Bit	-	5/32" Slotted Bit	-	#2 Phillips Bit	-	T-30 Torx® Bit
-	5/16" Hex Bit	-	7/32" Slotted Bit	-	#3 Phillips Bit	-	T-40 Torx® Bit
-	3mm Hex Bit	-	1/4" Slotted Bit	-	T-8 Torx® Bit	-	

GEARWRENCH® 30 Pc. Bit Set in Box

Premium S2 Quality Steel Bits



Cat. No.	UPC No.	Packaging	Product Weight
890003GD	082171089008	Bagged	0.25 lb

Cat. No.	Description	Cat. No.	Description	Cat. No.	Description	Cat. No.	Description
-	1/8" Hex Bit	-	5mm Hex Bit	-	5.5mm Slotted Bit	-	T-15 Torx® Bit
-	5/32" Hex Bit	-	6mm Hex Bit	-	6.5mm Slotted Bit	-	T-20 Torx® Bit
-	3/16" Hex Bit	-	7mm Hex Bit	-	#0 Phillips Bit	-	T-25 Torx® Bit
-	7/32" Hex Bit	-	8mm Hex Bit	-	#1 Phillips Bit	-	T-27 Torx® Bit
-	1/4" Hex Bit	-	5/32" Slotted Bit	-	#2 Phillips Bit	-	T-30 Torx® Bit
-	5/16" Hex Bit	-	7/32" Slotted Bit	-	#3 Phillips Bit	-	T-40 Torx® Bit
-	3mm Hex Bit	-	1/4" Slotted Bit	-	T-8 Torx® Bit		
-	4mm Hex Bit	-	4mm Slotted Bit	-	T-10 Torx® Bit		

GEARWRENCH® 10 Pc. Bit Set with Adapter

Premium S2 Quality Steel Bits



Cat. No.	UPC No.	Packaging	Product Weight
890010GD	082171900105	Bagged	0.15 lb

Cat. No.	Description	Cat. No.	Description	Cat. No.	Description	Cat. No.	Description
-	#1 Phillips Bit	-	4mm Slotted Bit	-	T-10 Torx® Bit	-	T-25 Torx® Bit
-	#2 Phillips Bit	-	5.5mm Slotted Bit	-	T-15 Torx® Bit		
-	#3 Phillips Bit	-	6.5mm Slotted Bit	-	T-20 Torx® Bit		

GEARWRENCH® 2 Pc. Offset Screwdriver Set

- 1/4" Slotted X #2 Phillips Offset Screwdriver
- 3/16" Slotted X #1 Phillips Offset Screwdriver

Cat. No.	UPC No.	Packaging	Product Weight
80072	099575800726	Carded	0.08 lb



GEARWRENCH® Phillips Screw Starter

- Holds Screw Securely for Use in Hard-To-Reach Areas
- Twist the Bit to Hold Screw for Easy Starting
- Strong Magnet on Opposite End Picks Up Dropped Parts
- Also Includes a Pocket Clip Length: 5-5/8"

Cat. No.	UPC No.	Packaging	Product Weight
2283	082171022838	Carded	0.05 lb



GEARWRENCH® Slotted Screw Starter

- Holds Screw Securely for Use in Hard-To-Reach Areas
- Twist the Bit to Hold Screw for Easy Starting
- Strong Magnet on Opposite End Picks Up Dropped Parts
- Also Includes a Pocket Clip Length: 5-5/8"

Cat. No.	UPC No.	Packaging	Product Weight
2282D	082171022821	Carded	0.07 lb



GEARWRENCH® 16 Pc. Ratcheting Nutdriver Set - SAE/Metric

- Precision, Fine Tooth, Reversible Ratcheting Mechanism
- Interchangeable, Color Coded Nutdriver Shafts
- Contoured, Dual Material Comfort Grip
- Oil and Solvent Resistant



Cat. No.	UPC No.	Packaging	Product Weight
8916D	082171089169	Boxed	2.60 lb

Cat. No.	Description	Cat. No.	Description	Cat. No.	Description
890005GD	Ratcheting Screwdriver Stubby Handle 1/4" Drive	890140GD	7/16" Nutdriver Shaft	891090GD	9mm Nutdriver Shaft
890060GD	3/16" Nutdriver Shaft	890160GD	1/2" Nutdriver Shaft	891100GD	10mm Nutdriver Shaft
890080GD	1/4" Nutdriver Shaft	891050GD	5mm Nutdriver Shaft	891110GD	11mm Nutdriver Shaft
890100GD	5/16" Nutdriver Shaft	891060GD	6mm Nutdriver Shaft	891120GD	12mm Nutdriver Shaft
890110GD	11/32" Nutdriver Shaft	891070GD	7mm Nutdriver Shaft		
890120GD	3/8" Nutdriver Shaft	891080GD	8mm Nutdriver Shaft		

GEARWRENCH® 8 Pc. Ratcheting Nutdriver Set - SAE

- Precision, Fine Tooth, Reversible Ratcheting Mechanism
- Interchangeable, Color Coded Nutdriver Shafts
- Contoured, Dual Material Comfort Grip
- Oil and Solvent Resistant



Cat. No.	UPC No.	Packaging	Product Weight
8908D	082171089084	Boxed	1.70 lb

Cat. No.	Description	Cat. No.	Description
890005GD	Ratcheting Screwdriver Stubby Handle 1/4" Drive	890110GD	11/32" Nutdriver Shaft
890060GD	3/16" Nutdriver Shaft	890120GD	3/8" Nutdriver Shaft
890080GD	1/4" Nutdriver Shaft	890140GD	7/16" Nutdriver Shaft
890100GD	5/16" Nutdriver Shaft	890160GD	1/2" Nutdriver Shaft

GEARWRENCH® 9 Pc. Ratcheting Nutdriver Set - Metric

- Precision, Fine Tooth, Reversible Ratcheting Mechanism
- Interchangeable, Color Coded Nutdriver Shafts
- Contoured, Dual Material Comfort Grip
- Oil and Solvent Resistant



Cat. No.	UPC No.	Packaging	Product Weight
8909D	082171089091	Boxed	1.95 lb

Cat. No.	Description	Cat. No.	Description
890005GD	Ratcheting Screwdriver Stubby Handle 1/4" Drive	891090GD	9mm Nutdriver Shaft
891050GD	5mm Nutdriver Shaft	891100GD	10mm Nutdriver Shaft
891060GD	6mm Nutdriver Shaft	891110GD	11mm Nutdriver Shaft
891070GD	7mm Nutdriver Shaft	891120GD	12mm Nutdriver Shaft
891080GD	8mm Nutdriver Shaft		

GEARWRENCH® Ratcheting Nutdriver Shafts

- Color Coded for Size Identification
- Etched with Size on Shaft



Cat. No.	UPC No.	Packaging	Description	Fastener Size	Shaft Length	Product Weight
890008GD	082171900082	Carded	11" 1/4" Shank 180° Flex Bit Shaft	1/4 in	11 in	0.30 lb
890009GD	082171900099	Carded	11" 1/4" Shank 180° Flex Socket Shaft	1/4 in	11 in	0.27 lb
890060GD	082171900600	Carded	3/16" Nutdriver Shaft	3/16 in	-	0.10 lb
890080GD	082171800801	Carded	1/4" Nutdriver Shaft	1/4 in	-	0.10 lb
890100GD	082171801006	Carded	5/16" Nutdriver Shaft	5/16 in	-	0.10 lb
890110GD	082171901102	Carded	11/32" Nutdriver Shaft	11/32 in	-	0.10 lb
890120GD	082171901201	Carded	3/8" Nutdriver Shaft	3/8 in	-	0.10 lb
890140GD	082171901409	Carded	7/16" Nutdriver Shaft	7/16 in	-	0.10 lb
890160GD	082171901607	Carded	1/2" Nutdriver Shaft	1/2 in	-	0.10 lb
891050GD	082171910500	Carded	5mm Nutdriver Shaft	5 mm	-	0.10 lb
891060GD	082171910609	Carded	6mm Nutdriver Shaft	6 mm	-	0.10 lb
891070GD	082171810701	Carded	7mm Nutdriver Shaft	7 mm	-	0.10 lb
891080GD	082171910807	Carded	8mm Nutdriver Shaft	8 mm	-	0.10 lb
891090GD	082171910906	Carded	9mm Nutdriver Shaft	9 mm	-	0.10 lb
891100GD	082171911002	Carded	10mm Nutdriver Shaft	10 mm	-	0.10 lb
891110GD	082171911101	Carded	11mm Nutdriver Shaft	11 mm	-	0.10 lb
891120GD	082171911200	Carded	12mm Nutdriver Shaft	12 mm	-	0.10 lb

GEARWRENCH® 7 Pc. Hollow Shaft Cushion Grip Nutdriver Set - SAE

- Ergonomic Cushion Grip for Reduced Hand Fatigue and Greater Comfort



Cat. No.	UPC No.	Packaging	Product Weight
82765	099575827655	Carded	2.35 lb

Cat. No.	Description	Cat. No.	Description
82750	Cushion Grip Nutdriver 3/16 x 3"	82754	Cushion Grip Nutdriver 3/8 x 3"
82751	Cushion Grip Nutdriver 1/4 x 3"	82755	Cushion Grip Nutdriver 7/16 x 3"
82752	Cushion Grip Nutdriver 5/16 x 3"	82756	Cushion Grip Nutdriver 1/2 x 3"
82753	Cushion Grip Nutdriver 11/32 x 3"		



GEARWRENCH 7 Pc. Hollow Shaft Cushion Grip Nutdriver Set - Metric

Ergonomic Cushion Grip for Reduced Hand Fatigue and Greater Comfort



mm

Cat. No.	UPC No.	Packaging	Product Weight
82764	099575827648	Carded	2.53 lb

Cat. No.	Description	Cat. No.	Description
82757D	Cushion Grip Nutdriver 6 mm x 3"	82761	Cushion Grip Nutdriver 10 mm x 3"
82758	Cushion Grip Nutdriver 7 mm x 3"	82762	Cushion Grip Nutdriver 11 mm x 3"
82759	Cushion Grip Nutdriver 8 mm x 3"	82763	Cushion Grip Nutdriver 12 mm x 3"
82760	Cushion Grip Nutdriver 9 mm x 3"		

GEARWRENCH Cushion Grip Hollow Shaft Nutdrivers - SAE

Cushion Grip for Increased Comfort



SAE

Cat. No.	UPC No.	Packaging	Fastener Size	Shaft Length	Bolt Clearance	Overall Length	Handle Size (Dia. X Length)	Product Weight
82750	099575827501	Carded	3/16 in	3.000 in	0.185 in	7.330 in	1.42 in x 4.33 in	0.12 lb
82751	099575827518	Carded	1/4 in	3.000 in	0.25 in	7.330 in	1.42 in x 4.33 in	0.12 lb
82752	099575827525	Carded	5/16 in	3.000 in	0.312 in	7.330 in	1.42 in x 4.33 in	0.13 lb
82753	099575827532	Carded	11/32 in	3.000 in	0.343 in	7.330 in	1.42 in x 4.33 in	0.13 lb
82754	099575827549	Carded	3/8 in	3.000 in	0.375 in	7.330 in	1.42 in x 4.33 in	0.14 lb
82755	099575827556	Carded	7/16 in	3.000 in	0.437 in	7.330 in	1.42 in x 4.33 in	0.14 lb
82756	099575827563	Carded	1/2 in	3.000 in	0.500 in	8.000 in	1.50 in x 5.00 in	0.18 lb

GEARWRENCH Cushion Grip Hollow Shaft Nutdrivers - Metric

Cushion Grip for Increased Comfort



mm

Cat. No.	UPC No.	Packaging	Fastener Size	Shaft Length	Bolt Clearance	Overall Length	Handle Size (Dia. X Length)	Product Weight
82757D	099575827570	Carded	6 mm	3.000 in	0.236 in	7.330 in	1.42 in x 4.33 in	0.12 lb
82758	099575827587	Carded	7 mm	3.000 in	0.275 in	7.330 in	1.42 in x 4.33 in	0.12 lb
82759	099575827594	Carded	8 mm	3.000 in	0.314 in	7.330 in	1.42 in x 4.33 in	0.13 lb
82760	099575827600	Carded	9 mm	3.000 in	0.354 in	7.330 in	1.42 in x 4.33 in	0.13 lb
82761	099575827617	Carded	10 mm	3.000 in	0.393 in	7.330 in	1.42 in x 4.33 in	0.14 lb
82762	099575827624	Carded	11 mm	3.000 in	0.433 in	7.330 in	1.42 in x 4.33 in	0.14 lb
82763	099575827631	Carded	12 mm	3.000 in	0.472 in	8.000 in	1.50 in x 5.00 in	0.18 lb



GEARWRENCH®

Dual Material Pliers..... 344

Mini Pliers..... 347

Compound Action Pliers..... 351

Double-X Pliers..... 352

Insulated Pliers..... 355

Hose Clamp Pliers 357

Pinch Off Pliers 357

Snap & Retaining Ring Pliers..... 358

GEARWRENCH® Pliers

GearWrench® offers a broad range of pliers to meet the needs of most automotive and industrial applications. Ergonomic design, quality materials and precision assembly produce a tool that will get the job done for years to come.

GearWrench® delivers innovation with the Double-X, double joint pliers that allow the plier to reach where others can't. The two pivot points act to allow the jaws to open greater than the handles, that means better access to more places. They are constructed of corrosion resistant alloy steel for long life and have dual-dipped grips for user comfort.

DOUBLE-X™ PLIERS

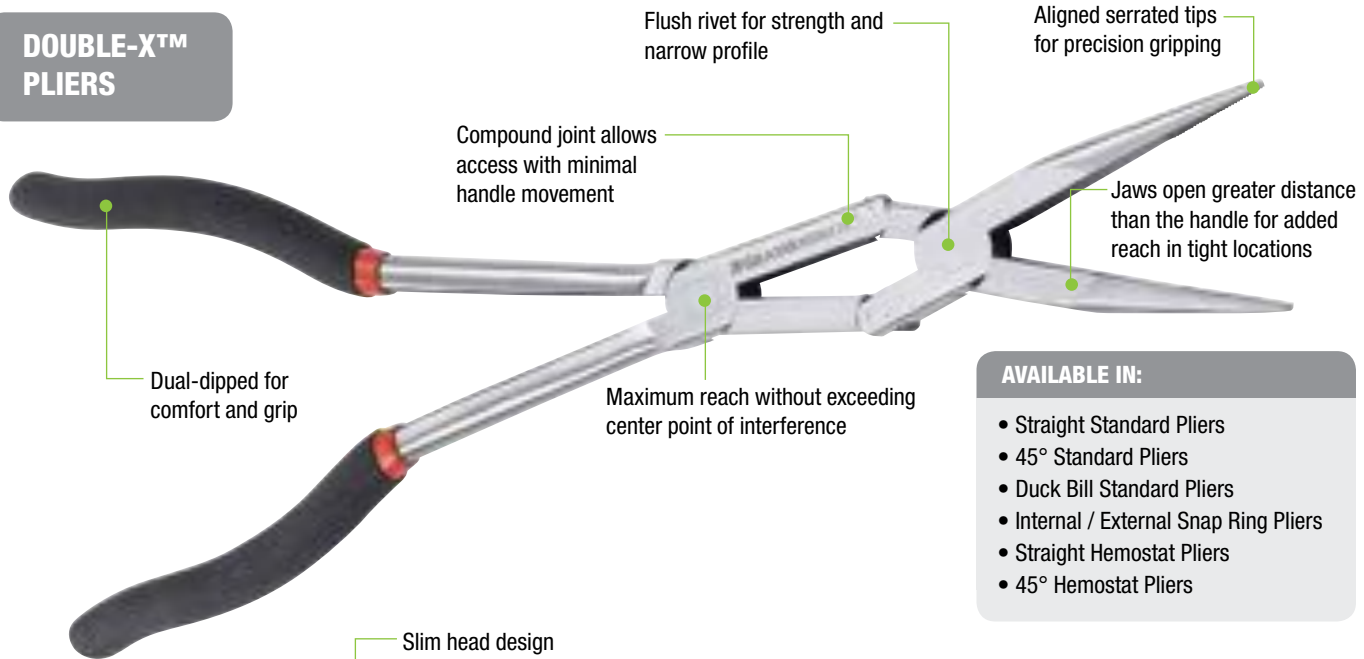

- AVAILABLE IN:**
- Straight Standard Pliers
 - 45° Standard Pliers
 - Duck Bill Standard Pliers
 - Internal / External Snap Ring Pliers
 - Straight Hemostat Pliers
 - 45° Hemostat Pliers

DUAL MATERIAL GRIP PLIERS

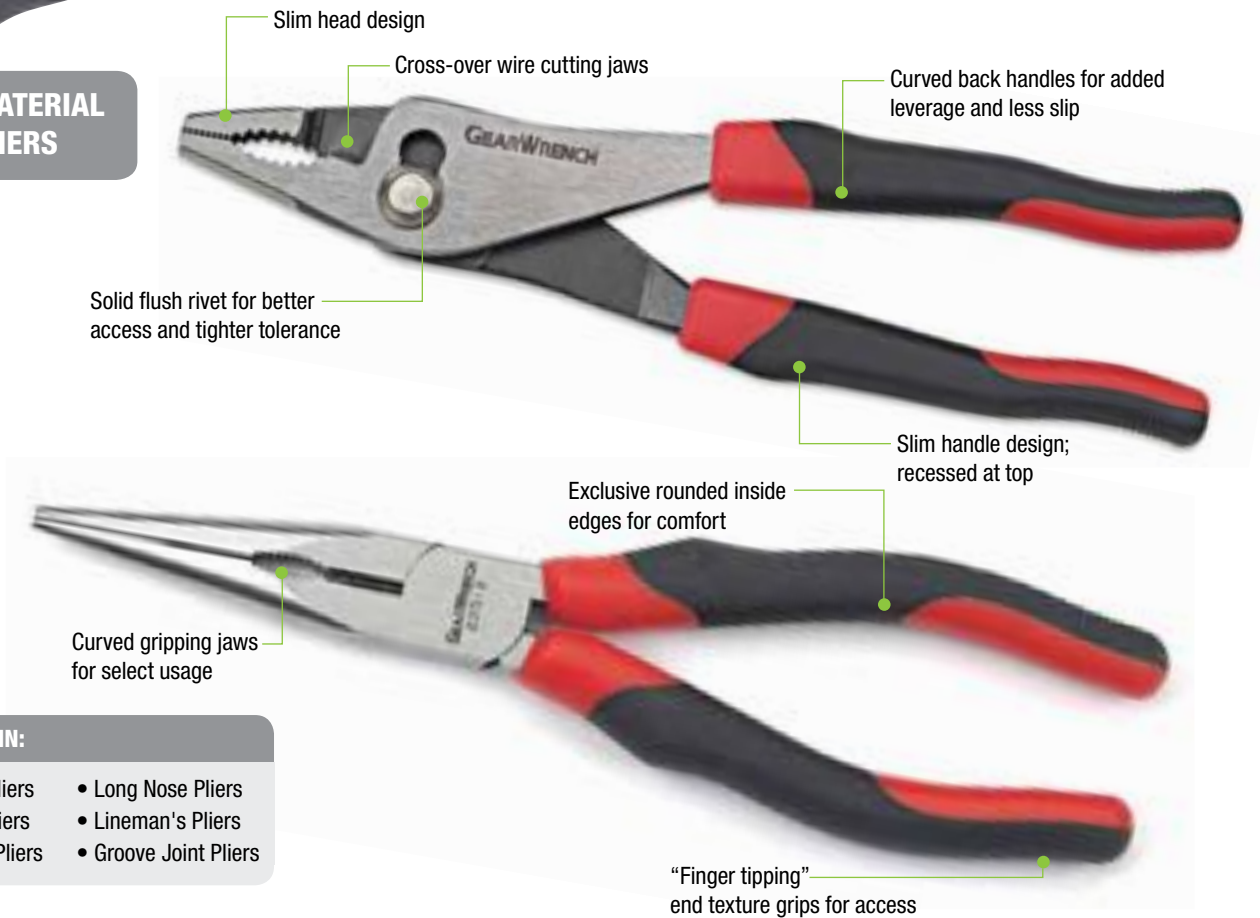

- AVAILABLE IN:**
- Slip Joint Pliers
 - Long Nose Pliers
 - Diagonal Pliers
 - Lineman's Pliers
 - Bent Nose Pliers
 - Groove Joint Pliers

**PIVOTFORCE™
PLIERS**

PIVOTFORCE

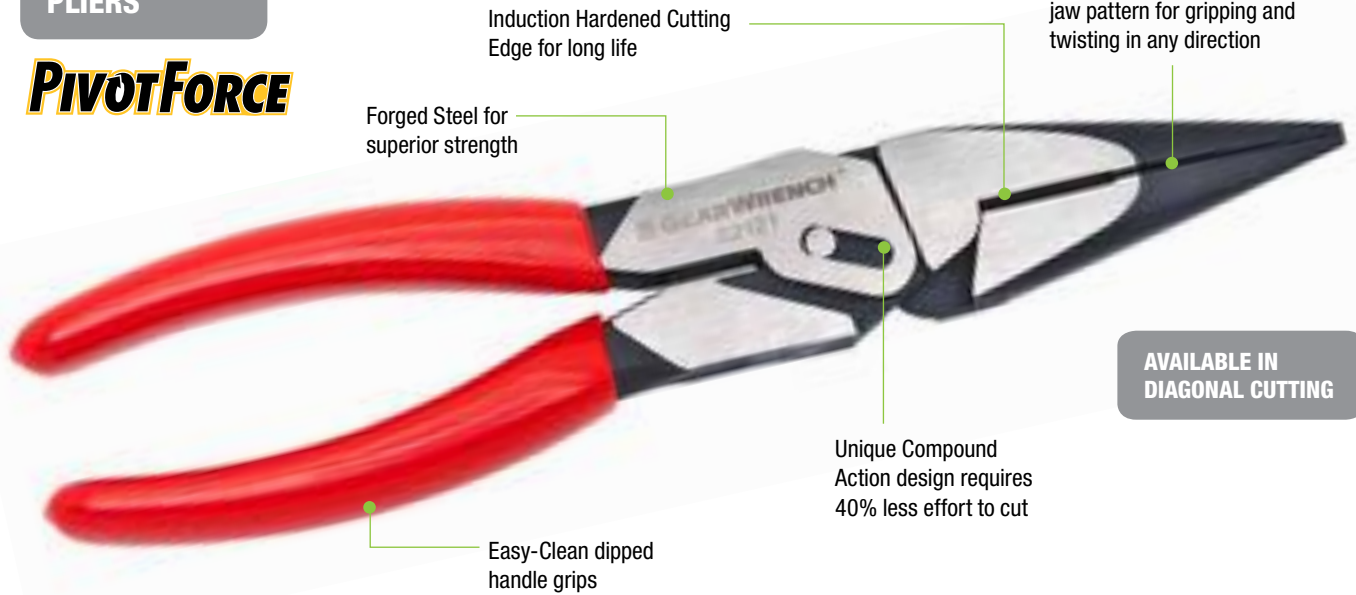

Induction Hardened Cutting Edge for long life

Machined, cross-checked jaw pattern for gripping and twisting in any direction

Forged Steel for superior strength

**AVAILABLE IN
DIAGONAL CUTTING**

Unique Compound Action design requires 40% less effort to cut

Easy-Clean dipped handle grips

**DIPPED GRIP
PLIERS**



Rivet Joint Assembly will not separate

Induction Hardened, Angled Teeth for increased grip

Easy-Clean dipped handle grips

Positive Interlocking Tongue and Groove design will not slip

Unique Forged Alloy Tool Steel for strength and durability

Laser-Hardened Cutting Edges



AVAILABLE IN:

- Slip Joint Pliers
- Long Nose Pliers
- Diagonal Pliers
- Lineman's Pliers
- Bent Nose Pliers
- Groove Joint Pliers

GEARWRENCH® 7 Pc. Mixed Pliers Set

- Forged From Premium Alloy Steel
- Precision Machined for Exact Tolerances and Fit
- Slim Handle and Head Design
- Curved Back Handles for Added Leverage and Less Slip
- Exclusive Rounded Inside Edges for Comfort
- "Finger Tipping" End Texture Grips for Access



Cat. No.	UPC No.	Packaging	Product Weight
82108	099575821080	Boxed	6.63 lb

Cat. No.	Description	Cat. No.	Description
82011	9-1/2" Tongue and Groove Pliers	82020D	12" Groove Joint Pliers with Straight Jaw
82012	7" Diagonal Cutting Pliers	82025	8" Lineman Pliers
82013	8" Long Nose Pliers	82028	8" End Cutting Nipper Pliers
82014	8" Slip Joint Pliers		

GEARWRENCH® 4 Pc. Mixed Pliers Set

- Forged From Premium Alloy Steel
- Precision Machined for Exact Tolerances and Fit
- Slim Handle and Head Design
- Curved Back Handles for Added Leverage and Less Slip
- Exclusive Rounded Inside Edges for Comfort
- "Finger Tipping" End Texture Grips for Access



Cat. No.	UPC No.	Packaging	Product Weight
82103	099575821035	Carded	3.09 lb

Cat. No.	Description	Cat. No.	Description
82011	9-1/2" Tongue and Groove Pliers	82013	8" Long Nose Pliers
82012	7" Diagonal Cutting Pliers	82014	8" Slip Joint Pliers

GEARWRENCH® 8 Pc. Mini Screwdriver and Pliers Set

- Dual Material Handles for Comfort and Performance
- Mini Screwdrivers feature a "Speed Zone" for Turning in Lower Torque Applications
- Mini Pliers Feature a Slim Head Design with a Solid Flush Rivet for Better Access and Tighter Tolerance



Cat. No.	UPC No.	Packaging	Product Weight
80058	099575800580	Carded	1.10 lb

Cat. No.	Description	Cat. No.	Description
80031	Dual Material Phillips® Screwdriver #00 x 60 mm	80035	Dual Material Slotted Screwdriver 2.0mm x 60 mm
80032	Dual Material Phillips® Screwdriver #0 x 60 mm	80036	Dual Material Slotted Screwdriver 2.5mm x 60 mm
80033	Dual Material Phillips® Screwdriver #1 x 60 mm	82000D	5" Mini Diagonal Cutting Pliers
80034	Dual Material Slotted Screwdriver 1.5mm x 60 mm	82001	5" Mini Long Nose Pliers

GEARWRENCH® 5 Pc. Mixed Mini Pliers Set

- Slim Head Design
- Solid Flush Rivet for Better Access and Tighter Tolerance
- Curved Back Handles for Added Leverage and Less Slip



Cat. No.	UPC No.	Packaging	Product Weight
82100	099575821004	Carded	0.99 lb

Cat. No.	Description	Cat. No.	Description
82000D	5" Mini Diagonal Cutting Pliers	82003	4-1/4" Mini End Cutting Nipper Pliers
82001	5" Mini Long Nose Pliers	82004	5-1/4" Mini Flat Nose Pliers
82002D	5" Mini Needle Nose Pliers		

GEARWRENCH® Slip Joint Pliers

- Slim Head Design
- Cross-Over Wire Cutting Jaws
- Curved Back Handles for Added Leverage and Less Slip
- Slim Handle Design Recessed at Top
- Solid Flush Rivet for Better Access and Tighter Tolerance



Cat. No.	UPC No.	Packaging	Overall Length	Jaw Length	Jaw Width	Jaw Thickness	Jaw Capacity	Jaw Type	Wire Cutter	Product Weight
82014	099575820144	Carded	8.15 in	1.72 in	1.24 in	0.14 in	3.13 in	Curved	Yes	0.60 lb

GEARWRENCH® Tongue and Groove Pliers

- Curved Jaws for Gripping Rounded Objects
- Forged From Premium Alloy Steel
- Precision Machined for Exact Tolerances and Fit
- Slim Handle and Head Design
- Curved Back Handles for Added Leverage and Less Slip
- Exclusive Rounded Inside Edges for Comfort



Cat. No.	UPC No.	Packaging	Overall Length	Jaw Length	Jaw Width	Jaw Thickness	Jaw Capacity	Jaw Type	Wire Cutter	Product Weight
82011	099575820113	Carded	9.45 in	1.61 in	0.73 in	0.41 in		Curved	No	0.84 lb

GEARWRENCH® Groove Joint Pliers with Straight Jaw

- Straight Jaws for Gripping Parallel Surfaces
- Forged From Premium Alloy Steel
- Precision Machined for Exact Tolerances and Fit
- Slim Handle and Head Design
- Curved Back Handles for Added Leverage and Less Slip
- Exclusive Rounded Inside Edges for Comfort



Cat. No.	UPC No.	Packaging	Overall Length	Jaw Length	Jaw Width	Jaw Thickness	Jaw Capacity	Jaw Type	Wire Cutter	Product Weight
82020D	099575820205	Carded	11.85 in	2.09 in	0.65 in	0.47 in	1.09 in	Straight	No	1.45 lb

GEARWRENCH® Diagonal Cutting Pliers

- Curved Back Handles for Added Leverage and Less Slip
- Slim Head Design
- Solid Flush Rivet for Better Access and Tighter Tolerance
- Slim Handle Design Recessed at Top



Cat. No.	UPC No.	Packaging	Application	Overall Length	Jaw Length	Jaw Width	Jaw Thickness	Edge Type/ Cut Capacity	Cutting Edge Length	Product Weight
82012	099575820120	Carded	Heavy Duty	7.01 in	1.12 in	1.2 in	0.46 in	Standard	1.12 in	0.63 lb

GEARWRENCH® Long Nose Pliers

- Curved Back Handles for Added Leverage and Less Slip
- Slim Head Design
- Solid Flush Rivet for Better Access and Tighter Tolerance
- Slim Handle Design Recessed at Top



Cat. No.	UPC No.	Packaging	Overall Length	Jaw Length	Jaw Width	Jaw Thickness	Jaw Type	Wire Cutter	Product Weight
82013	099575820137	Carded	8.23 in	3.28 in	0.84 in	0.42 in	Standard	Yes	0.64 lb

GEARWRENCH® Lineman's Pliers

- Curved Back Handles for Added Leverage and Less Slip
- Slim Head Design
- Solid Flush Rivet for Better Access and Tighter Tolerance
- Slim Handle Design Recessed at Top



Cat. No.	UPC No.	Packaging	Application	Overall Length	Jaw Length	Jaw Width	Jaw Thickness	Edge Type/ Cut Capacity	Cutting Edge Length	Product Weight
82025	099575820250	Carded	Heavy Duty	8.03 in	2.14 in	1.13 in	0.48 in	Standard	5/8 in	0.78 lb

GEARWRENCH® End Cutting Nipper Pliers

- Curved Back Handles for Added Leverage and Less Slip
- Slim Handle Design Recessed at Top



Cat. No.	UPC No.	Packaging	Application	Overall Length	Jaw Length	Jaw Width	Jaw Thickness	Edge Type/ Cut Capacity	Cutting Edge Length	Product Weight
82028	099575820281	Carded	Heavy Duty	7.8 in	0.59 in	1.17 in	1.02 in	Standard	1.02 in	0.80 lb

GEARWRENCH® Mini Diagonal Cutting Pliers

- Slim Head Design
- Solid Flush Rivet for Better Access and Tighter Tolerance
- Slim Handle Design Recessed at Top
- Spring Keeps Handles Open



Cat. No.	UPC No.	Packaging	Application	Overall Length	Jaw Length	Jaw Width	Jaw Thickness	Edge Type/Cut Capacity	Cutting Edge Length	Product Weight
82000D	099575820007	Carded	Mini	4.45 in	0.51 in	0.33 in	0.51 in	Mini	0.51 in	0.09 lb

GEARWRENCH® Mini Long Nose Pliers

- Slim Head Design
- Solid Flush Rivet for Better Access and Tighter Tolerance
- Slim Handle Design Recessed at Top
- Spring Keeps Handles Open



Cat. No.	UPC No.	Packaging	Overall Length	Jaw Length	Jaw Width	Jaw Thickness	Edge Type/Cut Capacity	Product Weight
82001	099575820014	Carded	5.2 in	1.47 in	0.5 in	0.33 in	Yes	0.09 lb

GEARWRENCH® Mini Needle Nose Pliers

- Slim Head Design
- Solid Flush Rivet for Better Access and Tighter Tolerance
- Slim Handle Design Recessed at Top
- Spring Keeps Handles Open



Cat. No.	UPC No.	Packaging	Overall Length	Jaw Length	Jaw Width	Jaw Thickness	Edge Type/Cut Capacity	Product Weight
82002D	099575820021	Carded	5.59 in	1.84 in	0.5 in	0.33 in	No	0.09 lb

GEARWRENCH® Mini End Cutting Nipper Pliers

- Slim Head Design
- Solid Flush Rivet for Better Access and Tighter Tolerance
- Slim Handle Design Recessed at Top
- Spring Keeps Handles Open



Cat. No.	UPC No.	Packaging	Application	Overall Length	Jaw Length	Jaw Width	Jaw Thickness	Edge Type/Cut Capacity	Cutting Edge Length	Product Weight
82003	099575820038	Carded	Mini	4.25 in	0.51 in	0.5 in	0.51 in	Standard	0.51 in	0.09 lb

GEARWRENCH® Mini Flat Nose Pliers

- Slim Head Design
- Solid Flush Rivet for Better Access and Tighter Tolerance
- Slim Handle Design Recessed at Top
- Spring Keeps Handles Open



Cat. No.	UPC No.	Packaging	Application	Overall Length	Jaw Length	Jaw Width	Jaw Thickness	Edge Type/Cut Capacity	Cutting Edge Length	Product Weight
82004	099575820045	Carded	Mini	5.2 in	1.47 in	0.5 in	0.33 in	Standard	N/A	0.09 lb

GEARWRENCH® 7 Pc. Mixed Pliers Set

- Unique Forged Alloy Tool Steel for Strength and Durability
- Clear Anti-Rust Coating
- Professional Easy-Clean Dipped Grips
- Meets or Exceeds Applicable ASME Requirements
- Laser-Hardened Cutting Edge for Longer Life on Cutting pliers
- Induction Hardened, Angled Teeth for Increased Grip on Tongue and Groove Pliers



Cat. No.	UPC No.	Description
82116	099575820618	7 Pc. Mixed Pliers Set

Cat. No.	Description	Cat. No.	Description
82063	10" Tongue and Groove Pliers, Straight Jaw	82071	7" Heavy-Duty Diagonal Cutting Pliers
82065	12" Tongue and Groove Pliers, Straight Jaw	82073	7-1/2" Long Nose Side Cutting Pliers
82069	8" Slip Joint Pliers	82075	8" Lineman Pliers, with Side Cutting

GEARWRENCH® 4 Pc. Mixed Pliers Set

- Unique Forged Alloy Tool Steel for Strength and Durability
- Clear Anti-Rust Coating
- Professional Easy-Clean Dipped Grips
- Meets or Exceeds Applicable ASME Requirements
- Laser-Hardened Cutting Edge for Longer Life on Cutting pliers
- Induction Hardened, Angled Teeth for Increased Grip on Tongue and Groove Pliers



Cat. No.	UPC No.	Description
82114	099575082146	4 Pc. Mixed Pliers Set

Cat. No.	Description	Cat. No.	Description
82063	10" Tongue and Groove Pliers, Straight Jaw	82071	7" Heavy-Duty Diagonal Cutting Pliers
82069	8" Slip Joint Pliers	82073	7-1/2" Long Nose Side Cutting Pliers

GEARWRENCH® Tongue and Groove Pliers, Straight Jaw

- Positive Interlocking Tongue and Groove Design Will Not Slip
- Rivet Joint Assembly Will Not Separate
- Induction Hardened, Angled Teeth for Increased Grip
- Multiple Jaw Positions for Optimized Handle Span and Improved Gripping Comfort
- Professional Easy-Clean Dipped Grips
- Clear Anti-Rust Coating
- Meets or Exceeds Applicable ASME Requirements



Cat. No.	UPC No.	Packaging	Overall Length	Jaw Capacity	Jaw Type	Product Weight
82063	099575820632	Carded	10 in	1-13/16 in	Straight	0.98 lb
82065	099575820656	Carded	12 in	3 in	Straight	1.50 lb
82066	099575820069	Carded	16 in	4-1/2 in	Straight	2.85 lb

GEARWRENCH® Tongue and Groove Pliers, V-Jaw

- Positive Interlocking Tongue and Groove Design Will Not Slip
- Rivet Joint Assembly Will Not Separate
- Induction Hardened, Angled Teeth for Increased Grip
- Multiple Jaw Positions for Optimized Handle Span and Improved Gripping Comfort
- Professional Easy-Clean Dipped Grips
- Clear Anti-Rust Coating
- Meets or Exceeds Applicable ASME Requirements



Cat. No.	UPC No.	Packaging	Overall Length	Jaw Capacity	Jaw Type	Product Weight
82064	099575820649	Carded	10 in	1-13/16 in	V-Jaw	0.98 lb

GEARWRENCH® Slip Joint Pliers

- 2-Positions for Increased Flexibility
- Rivet Joint Assembly Will Not Separate
- Machined Teeth for Gripping Flat or Round Objects
- Shear Style Wire Cutter
- Professional Easy-Clean Dipped Grips
- Meets or Exceeds Applicable ASME Requirements



Cat. No.	UPC No.	Packaging	Overall Length	Jaw Capacity	Jaw Type	Wire Cutter	Product Weight
82068	099575820687	Carded	6.5 in	1 in	Curved	Yes	0.50 lb
82069	099575820694	Carded	8 in	1 in	Curved	Yes	0.69 lb

GEARWRENCH® Diagonal Cutting Pliers, General Purpose

- Laser-Hardened Cutting Edge for Longer Life
- For General Wire Cutting and Flush Cutting
- Unique Forged Alloy Tool Steel for Strength and Durability
- Professional Easy-Clean Dipped Grips
- Clear Anti-Rust Coating
- Meets or Exceeds Applicable ASME Requirements



Cat. No.	UPC No.	Packaging	Overall Length	Jaw Length	Jaw Width	Jaw Thickness	Edge Type/Cut Capacity	Wire Cutter	Product Weight
82070	099575802706	Carded	6 in	13/16 in	3/4 in	7/16 in	Std./12 AWG	Yes	0.40 lb

GEARWRENCH Diagonal Cutting Pliers, Heavy-Duty

- Laser-Hardened Cutting Edge for Longer Life
- For General Wire Cutting and Flush Cutting
- Unique Forged Alloy Tool Steel for Strength and Durability
- Clear Anti-Rust Coating
- Professional Easy-Clean Dipped Grips
- Meets or Exceeds Applicable ASME Requirements



Cat. No.	UPC No.	Packaging	Overall Length	Jaw Length	Jaw Width	Jaw Thickness	Edge Type/Cut Capacity	Wire Cutter	Product Weight
82071	099575820717	Carded	7 in	25/32 in	1-7/32 in	15/32 in	Std./12 AWG	Yes	0.65 lb

GEARWRENCH Long Nose Pliers, with Side Cutting

- Laser-Hardened Cutting Edge for Longer Life
- Designed for Access in Confined Spaces
- Fine Serrated Jaws Grip Work Tightly
- Unique Forged Alloy Tool Steel for Strength and Durability
- Clear Anti-Rust Coating
- Professional Easy-Clean Dipped Grips
- Meets or Exceeds Applicable ASME Requirements



Cat. No.	UPC No.	Packaging	Overall Length	Jaw Length	Jaw Width	Jaw Thickness	Edge Type/Cut Capacity	Product Weight
82072	099575820724	Carded	6.6 in	1-7/8 in	11/16 in	3/8 in	Std./14 AWG	0.34 lb
82073	099575820731	Carded	7.5 in	2-21/32 in	3/4 in	3/8 in	Std./14 AWG	0.45 lb

GEARWRENCH Curved Needle Nose Pliers

- Thin Bent Nose for access in confined spaces
- Fine Serrated Jaws Grip Work Tightly
- Unique Forged Alloy Tool Steel for Strength and Durability
- Clear Anti-Rust Coating
- Professional Easy-Clean Dipped Grips
- Meets or Exceeds Applicable ASME Requirements



Cat. No.	UPC No.	Packaging	Overall Length	Jaw Length	Jaw Width	Jaw Thickness	Wire Cutter	Product Weight
82074	099575820748	Carded	6 in	1 in	11/16 in	3/8 in	No	0.46 lb

GEARWRENCH Lineman Pliers, with Side Cutting

- Laser-Hardened Cutting Edge for Longer Life
- Machined Serrated Jaws Grip Work Tightly
- Unique Forged Alloy Tool Steel for Strength and Durability
- Clear Anti-Rust Coating
- Professional Easy-Clean Dipped Grips
- Meets or Exceeds Applicable ASME Requirements



Cat. No.	UPC No.	Overall Length	Jaw Length	Jaw Width	Jaw Thickness	Edge Type/Cut Capacity	Cutting Edge Length	Wire Cutter	Product Weight
82075	099575820755	8.3 in	1-15/32 in	1-1/8 in	9/16 in	Std./11 AWG	3/4 in	Yes	0.94 lb

GEARWRENCH® End Nipper Plier 7"

- Laser-Hardened Cutting Edge for longer life
- Throat designed to give maximum clearance
- Clear Anti-Rust Coating
- Unique Forged Alloy Tool Steel for strength and durability
- Meets or Exceeds Applicable ASME requirements



Cat. No.	UPC No.	Length	Wire Size	Jaw Length	Jaw Width	Jaw Thickness	Cutting Edge Length	Product Weight
82076	099575820762	7-1/4 in	Std./12 AWG	3/8 in	1-3/4 in	17/32 in	13/16 in	0.80 lb

GEARWRENCH® 2 Pc. PivotForce Compound Action *PIVOTFORCE* Plier Set

- Unique Compound Action Requires 40% Less Effort To Cut
- Induction Hardened Cutting Edge for Long Life
- Forged Steel for Superior Strength and Durability
- Anti-Rust Coating
- Professional Easy-Clean Dipped Grips
- Meets or Exceeds Applicable ASME Performance Requirements



Cat. No.	UPC No.	Description
82124	099575822421	2 Pc. PivotForce Compound Action Plier Set

Cat. No.	Description	Cat. No.	Description
82120	8" PivotForce Diagonal Cutting Compound Action Plier	82121	8" PivotForce Long Nose Cutting Compound Action Plier

GEARWRENCH® PivotForce Diagonal Cutting Compound Action Plier

PIVOTFORCE

- Unique Compound Action Requires 40% Less Effort To Cut
- Induction Hardened Cutting Edge for Long Life
- Designed with Standard Bevel Edges for General Wire Cutting
- Forged Steel for Superior Strength and Durability
- Anti-Rust Coating
- Professional Easy-Clean Dipped Grips
- Meets or Exceeds Applicable ASME Performance Requirements



Cat. No.	UPC No.	Packaging	Overall Length	Jaw Length	Jaw Width	Jaw Thickness	Edge Type/ Cut Capacity	Jaw Capacity	Cutting Edge Length	Wire Cutter
82120	099575821202	Carded	7-3/5 in	1 in	1-1/10 in	35/64 in	Std./12 AWG	3/4 in	1 in	Yes

GEARWRENCH® PivotForce Long Nose Cutting Compound Action Plier

PIVOTFORCE

- Unique Compound Action Requires 40% Less Effort To Cut
- Induction Hardened Cutting Edge for Long Life
- Designed for Access in Confined Spaces
- Machined, Cross Checked Jaw Pattern for Gripping and Twisting in Any Direction
- Forged Steel for Superior Strength and Durability
- Anti-Rust Coating
- Professional Easy-Clean Dipped Grips
- Meets or Exceeds Applicable ASME Performance Requirements



Cat. No.	UPC No.	Packaging	Overall Length	Jaw Length	Jaw Width	Jaw Thickness	Edge Type/ Cut Capacity	Jaw Capacity	Cutting Edge Length	Wire Cutter
82121	099575821219	Carded	8-1/4 in	2-25/64 in	1-1/10 in	35/64 in	Std./ 12 AWG	1-3/8 in	53/64 in	Yes

GEARWRENCH® 2 Pc. Double-X™ Pliers Set

- Compound Joint Allows Access with Minimal Handle Movement
- Flush Rivet for Strength and Narrow Profile
- Maximum Reach Without Exceeding Center Point of Interference
- Jaws Open Greater Distance Than the Handle for Added Reach in Tight Locations



Cat. No.	UPC No.	Packaging	Product Weight
82106	099575821165	Carded	1.81 lb

Cat. No.	Description	Cat. No.	Description
82005D	Straight Double-X™ Pliers	82006D	45 Degree Double-X™ Pliers

GEARWRENCH® 3 Pc. Double-X™ Hose Grip Pliers Set

- Compound Joint Allows Access with Minimal Handle Movement
- Flush Rivet for Strength and Narrow Profile
- Maximum Reach Without Exceeding Center Point of Interference
- Jaws Open Greater Distance Than the Handle for Added Reach in Tight Locations



Cat. No.	UPC No.	Packaging	Product Weight
82107	099575821172	Carded	3.07 lb

Cat. No.	Description	Cat. No.	Description
82017	5/16" Diameter Hose Grip Double-X™ Pliers	82019	3/4" Diameter Hose Grip Double-X™ Pliers
82018	1/2" Diameter Hose Grip Double-X™ Pliers		

GEARWRENCH® 2 Pc. Double-X™ Internal/External Snap Ring Pliers Set

- Interchangeable Straight and 90 Degree Tips
- Corrosion Resistant Alloy Steel
- Compound Joint Allows Access with Minimal Handle Movement
- Flush Rivet for Strength and Narrow Profile
- Maximum Reach Without Exceeding Center Point of Interference
- Jaws Open Greater Distance Than the Handle for Added Reach in Tight Locations



Cat. No.	UPC No.	Packaging	Product Weight
82110	099575821103	Carded	2.14 lb

Cat. No.	Description	Cat. No.	Description
82032	Double-X™ Internal Snap Ring Pliers	315177	Tip Set: 0.038" Straight; 0.038" 90 Degree, 0.047" Straight, 0.047" 90 Degree, 0.070" Straight, 2 mm Hex Key
82033	Double-X™ External Snap Ring Pliers		

GEARWRENCH® 2 Pc. Double-X™ Hemostat Pliers Set

- Straight or 45 Degree Tips
- Compound Joint
- Stainless Steel
- Locking Function



Cat. No.	UPC No.	Packaging	Product Weight
82111	099575082115	Carded	0.65 lb

Cat. No.	Description	Cat. No.	Description
82034	Double-X™ Straight Hemostat Pliers	82035	Double-X™ 45 Degree Hemostat Pliers

GEARWRENCH® Straight Double-X™ Pliers

- Maximum Reach Without Exceeding Center Point of Interference
- Compound Joint Allows Access with Minimal Handle Movement
- Flush Rivet for Strength and Narrow Profile
- Jaws Open Greater Distance Than the Handle for Added Reach in Tight Locations
- Aligned Serrated Tips for Precision Gripping



Cat. No.	UPC No.	Packaging	Overall Length	Jaw Length	Jaw Width	Jaw Thickness	Product Weight
82005D	099575820151	Carded	13.46 in	3.15 in	0.68 in	0.39 in	0.94 lb

GEARWRENCH® 45 Degree Double-X™ Pliers

- Maximum Reach Without Exceeding Center Point of Interference
- Compound Joint Allows Access with Minimal Handle Movement
- Flush Rivet for Strength and Narrow Profile
- Jaws Open Greater Distance Than the Handle for Added Reach in Tight Locations
- Aligned Serrated Tips for Precision Gripping



Cat. No.	UPC No.	Packaging	Overall Length	Jaw Length	Jaw Width	Jaw Thickness	Product Weight
82006D	099575820168	Carded	13.27 in	2.95 in	0.68 in	0.39 in	0.93 lb

GEARWRENCH Duckbill Double-X™ Pliers

- Maximum Reach Without Exceeding Center Point of Interference
- Compound Joint Allows Access with Minimal Handle Movement
- Flush Rivet for Strength and Narrow Profile
- Jaws Open Greater Distance Than the Handle for Added Reach in Tight Locations
- Aligned Serrated Tips for Precision Gripping



Cat. No.	UPC No.	Packaging	Overall Length	Jaw Length	Jaw Width	Jaw Thickness	Product Weight
82007	099575820175	Carded	11.97 in	1.65 in	0.68 in	0.39 in	0.89 lb

GEARWRENCH Hose Grip Double-X™ Pliers

- Maximum Reach Without Exceeding Center Point of Interference
- Compound Joint Allows Access with Minimal Handle Movement
- Flush Rivet for Strength and Narrow Profile
- Jaws Open Greater Distance Than the Handle for Added Reach in Tight Locations



Cat. No.	UPC No.	Packaging	Overall Length	Jaw Length	Jaw Width	Jaw Thickness	Jaw Capacity	Product Weight
82017	099575821073	Carded	13.19 in	2.87 in	0.68 in	0.39 in	5/16 in	0.96 lb
82018	099575820182	Carded	13.13 in	2.81 in	0.68 in	0.39 in	1/2 in	0.96 lb
82019	099575820199	Carded	13.03 in	2.72 in	0.68 in	0.39 in	3/4 in	0.95 lb

GEARWRENCH Internal Snap Ring Double-X™ Pliers

- Interchangeable Straight and 90 Degree Tips
- Corrosion Resistant Alloy Steel
- Maximum Reach Without Exceeding Center Point of Interference
- Flush Rivet for Strength and Narrow Profile
- Jaws Open Greater Distance Than the Handle for Added Reach in Tight Locations
- Tip Set: .038" Straight; .038" 90 Degree, .047" Straight, .047" 90 Degree, .070" Straight, 2 mm Hex Key



Cat. No.	UPC No.	Packaging	Overall Length	Jaw Length	Jaw Width	Jaw Thickness	Product Weight
82032	099575820328	Carded	13.46 in	3.15 in	0.68 in	0.39 in	1.06 lb

GEARWRENCH External Snap Ring Double-X™ Pliers

- Interchangeable Straight and 90 Degree Tips
- Corrosion Resistant Alloy Steel
- Maximum Reach Without Exceeding Center Point of Interference
- Flush Rivet for Strength and Narrow Profile
- Jaws Open Greater Distance Than the Handle for Added Reach in Tight Locations
- Tip Set: .038" Straight; .038" 90 Degree, .047" Straight, .047" 90 Degree, .070" Straight, 2 mm Hex Key



Cat. No.	UPC No.	Packaging	Overall Length	Jaw Length	Jaw Width	Jaw Thickness	Product Weight
82033	099575820335	Carded	13.46 in	3.15 in	0.68 in	0.39 in	1.12 lb

GEARWRENCH® Straight Hemostat Double-X™ Pliers

- Straight Tips
- Stainless Steel
- Compound Action
- Locking Function



Cat. No.	UPC No.	Packaging	Overall Length	Jaw Length	Jaw Width	Jaw Thickness	Product Weight
82034	099575820342	Carded	9.84 in	4.22 in	0.16 in	0.13 in	0.23 lb

GEARWRENCH® 45 Degree Hemostat Double-X™ Pliers

- 45 Degree Tips
- Stainless Steel
- Compound Action
- Locking Function



Cat. No.	UPC No.	Packaging	Overall Length	Jaw Length	Jaw Width	Jaw Thickness	Product Weight
82035	099575820359	Carded	9.73 in	4.09 in	0.16 in	0.13 in	0.23 lb

GEARWRENCH® 10 Pc. Insulated Pliers and Screwdriver Set

- Insulated Pliers and Screwdrivers Are 1000 Volt Rated
- 100% Tested for Reliability



Cat. No.	UPC No.	Packaging	Product Weight
80062	099575800627	Boxed	3.50 lb

Cat. No.	Description	Cat. No.	Description
80047	Insulated Slotted Screwdriver 3/32" x 3"	82029	8" Lineman Insulated Pliers
80048	Insulated Slotted Screwdriver 5/32" x 4"	82030	8" Long Nose Insulated Pliers
80049	Insulated Slotted Screwdriver 7/32" x 5"	82031	7" Diagonal Cutting Insulated Pliers
80084	Insulated Pozidriv® Screwdriver #1 x 3-1/8"	80081	Insulated Phillips® Screwdriver #1 x 3-1/8"
80085D	Insulated Pozidriv® Screwdriver #2 x 4"	80082	Insulated Phillips® Screwdriver #2 x 4"

GEARWRENCH® Lineman's Insulated Pliers

- Curved Back Handles for Added Leverage and Less Slip
- Slim Head Design
- Solid Flush Rivet for Better Access and Tighter Tolerance
- Slim Handle Design Recessed at Top
- Insulated Pliers Are 1000 Volt Rated
- 100% Tested for Reliability



Cat. No.	UPC No.	Packaging	Application	Overall Length	Jaw Length	Jaw Width	Jaw Thickness	Edge Type/ Cut Capacity	Cutting Edge Length	Product Weight
82029	099575820298	Carded	Electrical	8.31 in	2.22 in	1.22 in	0.51 in	Standard	5/8 in	0.80 lb

GEARWRENCH® Long Nose Insulated Pliers

- Curved Back Handles for Added Leverage and Less Slip
- Slim Head Design
- Solid Flush Rivet for Better Access and Tighter Tolerance
- Slim Handle Design Recessed at Top
- Insulated Pliers Are 1000 Volt Rated
- 100% Tested for Reliability



Cat. No.	UPC No.	Packaging	Overall Length	Jaw Length	Jaw Width	Jaw Thickness	Jaw Type	Wire Cutter	Product Weight
82030	099575820304	Carded	8.39 in	3.26 in	0.87 in	0.43 in	Standard	Yes	0.60 lb

GEARWRENCH® Diagonal Cutting Insulated Pliers

- Curved Back Handles for Added Leverage and Less Slip
- Slim Head Design
- Solid Flush Rivet for Better Access and Tighter Tolerance
- Slim Handle Design Recessed at Top
- Insulated Pliers Are 1000 Volt Rated
- 100% Tested for Reliability



Cat. No.	UPC No.	Packaging	Application	Overall Length	Jaw Length	Jaw Width	Jaw Thickness	Edge Type/ Cut Capacity	Cutting Edge Length	Product Weight
82031	099575820311	Carded	Electrical	7.40 in	1.22 in	1.18 in	0.47 in	Standard	1.22 in	0.30 lb

GEARWRENCH® Battery Nut Pliers

- Loosen and Tighten Nuts on Battery Terminal Clamps
- Offset Handles for Working in Cramped Areas
- Serrated Jaws Provide Firm Grip



Cat. No.	UPC No.	Packaging	Product Weight
203D	082171002038	Carded	0.45 lb

GEARWRENCH® Spark Plug Terminal Pliers

- Safely Remove Spark Plug Cables and Prevent Cable Damage



Cat. No.	UPC No.	Packaging	Product Weight
135D	082171001352	Carded	0.53 lb

GEARWRENCH® Electrical Wire Stripper and Crimper

- All-Purpose Tool Includes Pliers Type Nose, Crimper, Wire Cutter, Stripper and Bolt Cutter
- Crimper Works on Insulated and Non-insulated Terminals. Non-insulated Auto 7 & 8mm, and Electrical 22-20 to 22-10. Insulated Electrical 22-20 to 12-10.
- Bolt Cutters for Bolt Sizes 4-40, 5-40, 6-32, 8-32, 10-32 and 10-24



Cat. No.	UPC No.	Packaging	Product Weight
2162D	082171021626	Carded	0.50 lb

GEARWRENCH® Straight Hose Clamp Pliers

- For Use on Hose Clamps - Flat Band
- Easy to Use Locking Feature
- Dual Dipped for Additional Comfort



Cat. No.	UPC No.	Packaging	Product Weight
3976D	082171397608	Carded	0.75 lb

GEARWRENCH® Angled Hose Clamp Pliers

- For Use on Hose Clamps - Flat Band
- Angled Jaws Give Improved Access Around Obstructions
- Easy to Use Locking Feature
- Dual Dipped for Additional Comfort



Cat. No.	UPC No.	Packaging	Product Weight
3977	082171397707	Carded	0.84 lb

GEARWRENCH® Corbin Style Hose Clamp Pliers

- For Corbin Style Hose Clamps
- Plier Tips Trap and Hold Clamp, and Swivel for Multiple Angle Access
- Easy to Use Locking Feature
- Dual Dipped for Additional Comfort



Cat. No.	UPC No.	Packaging	Product Weight
3975D	082171397509	Carded	0.74 lb

GEARWRENCH® Heavy-Duty Large Hose Clamp Pliers

- For Flat Ear Style Hose Clamps
- Plier Tips Trap and Hold Clamp, and Swivel for Multiple Angle Access
- Easy to Use Locking Feature
- Dual Dipped for Additional Comfort



Cat. No.	UPC No.	Packaging	Product Weight
3978D	082171397806	Carded	0.85 lb

GEARWRENCH® Hose Pinch Off Pliers

- Pliers Eliminate the Need to Drain Cooling System When Servicing
- Pliers Squeeze Hoses Shut and Jaws Swivel for Parallel Clamping
- Automatic Locking Ratchet
- Do Not Use on Wire-Reinforced Hose



Cat. No.	UPC No.	Packaging	Product Weight
145	082171001451	Carded	0.85 lb

GEARWRENCH® Small Hose Pinch-Off Pliers, 3/4" O.D. Capacity

- Ideal for Use on Radiator Hoses, Heater Hoses, Water, Air, Vacuum and Fuel Lines
- Capacity 3/4" Outside Diameter
- Extra Long Cushioned Hand Grips for Comfort and Control
- Clamping Mechanism Locks Automatically - No Screws Or Levers to Set Or Adjust
- Black Oxide Coated to Resist Rust and Corrosion



Cat. No.	UPC No.	Packaging	Length	Jaw Capacity	Product Weight
3791	082171037917	Carded	5-1/2 in	3/4 in	0.43 lb

GEARWRENCH® Medium Hose Pinch-Off Pliers, 1-1/4" O.D. Capacity

- Ideal for Use on Radiator Hoses, Heater Hoses, Water, Air, Vacuum and Fuel Lines
- Capacity 1-1/4" Outside Diameter
- Extra Long Cushioned Hand Grips for Comfort and Control
- Clamping Mechanism Locks Automatically - No Screws Or Levers to Set Or Adjust
- Black Oxide Coated to Resist Rust and Corrosion



Cat. No.	UPC No.	Packaging	Length	Jaw Capacity	Product Weight
3792D	082171037924	Carded	9-1/4 in	1-1/4 in	0.75 lb

GEARWRENCH® Large Hose Pinch-Off Pliers, 2-1/2" O.D. Capacity

- Ideal for Use on Radiator Hoses, Heater Hoses, Water, Air, Vacuum and Fuel Lines
- Capacity 2-1/2" Outside Diameter
- Extra Long Cushioned Hand Grips for Comfort and Control
- Clamping Mechanism Locks Automatically - No Screws Or Levers to Set Or Adjust
- Black Oxide Coated to Resist Rust and Corrosion



Cat. No.	UPC No.	Packaging	Length	Jaw Capacity	Product Weight
3793	082171037931	Carded	14 in	2-1/2 in	1.24 lb

GEARWRENCH® Lock-Ring Pliers

- Remove and Install Snap Rings Without Holes Used on Brakes, Transmissions, Pedal and Clutch Shafts
- Scored Jaws Securely Hold Rings



Cat. No.	UPC No.	Packaging	Product Weight
2534D	082171025341	Carded	0.45 lb

GEARWRENCH® Heavy-Duty Combination Snap Ring Pliers

- Remove and Install Heavy-Duty Internal Snap Rings From 2-7/16" to 3-1/2" and External Snap Rings From 1-1/2" to 4" in Diameter
- Points Lock Securely in Jaws
- Screw-Type Design Maintains Jaw Position During Use
- Includes 3 Pairs of Interchangeable Points



Cat. No.	UPC No.	Packaging	Length	Includes Tips Dia./ Angle	Product Weight
2012D	082171020124	Carded	9-1/2 in	0.108" Dia. 15° Angle, 0.108" Dia. 45° Angle and 0.123" Dia 45° Angle	1.30 lb

GEARWRENCH® 3 Pairs of Heavy-Duty Interchangeable Points Set

- For Heavy-Duty Snap Ring Pliers 454, 455, 456 and 2012D
- Includes 3 Pairs of Interchangeable Points and 1 Pair of Points Clamps With 2 Screws
- Requires 3/32" Hex Key When Replacing Points



Cat. No.	UPC No.	Packaging	Includes Tips Dia./ Angle	Product Weight
457	082171004575	Carded	0.108" Dia. 15°, 0.108" Dia. 45°, & 0.123" Dia. 45°	0.10 lb

GEARWRENCH® Combination Snap Ring Pliers

- Remove and Install Internal and External Snap Rings
- Tips Spread Up to 1-1/4"
- Tip Diameter 0.070"



Cat. No.	UPC No.	Packaging	Tip Description	Product Weight
1715D	082171017155	Carded	Tip Diameter 0.070"	0.10 lb

GEARWRENCH® Internal Snap Ring Pliers

- Remove and Install Internal Snap Rings From 3/8" to 1-3/4" in Diameter
- Includes 5 Pairs of Interchangeable Points
- Requires 5/64" Hex Key When Replacing Points
- Use Replacement Points Sets 447 and 448DD



Cat. No.	UPC No.	Packaging	Includes Tips Dia./ Angle	Product Weight
445	082171004452	Carded	0.039" Dia. 15° Angle; 0.048" Dia. 15° Angle; 0.074" Dia. 15° Angle; 0.039" Dia. 45° Angle; 0.047" Dia. 90° Angle;	0.35 lb

GEARWRENCH® External Snap Ring Pliers

- Remove and Install External Snap Rings From 1/4" to 1-7/16" in Diameter
- Includes 5 Pairs of Interchangeable Points
- Requires 5/64" Hex Key When Replacing Points
- Use Replacement Points Sets 447 and 448DD



Cat. No.	UPC No.	Packaging	Includes Tips Dia./ Angle	Product Weight
446D	082171004469	Carded	0.039" Dia. 15° Angle; 0.048" Dia. 15° Angle; 0.074" Dia. 15° Angle' 0.039" Dia. 45° Angle & 0.047" Dia. 90° Angle	0.35 lb

GEARWRENCH® 5 Pairs of Interchangeable Points Set

- For Snap Ring Pliers 445, 446D
- Includes 5 Pairs of Interchangeable Points & 1 Pair of Point Clamps With 2 Screws
- Requires 5/64" Hex Key When Replacing Points



Cat. No.	UPC No.	Packaging	Includes Tips Dia./ Angle	Product Weight
447	082171004476	Carded	1 Pair of Each Included: 0.039" Dia. 15°, 0.047" Dia. 15°, 0.074" Dia. 15°, 0.039" Dia. 45° & 0.047" Dia 90° Angle	0.06 lb

GEARWRENCH® 9 Pairs of Interchangeable Points Set

- For Snap Ring Pliers 445, 446D
- Includes 9 Pairs of Interchangeable Points & 2 Retaining Screws
- Requires 5/64" Hex Key When Replacing Points



Cat. No.	UPC No.	Packaging	Includes Tips Dia./ Angle	Product Weight
448DD	082171004483	Carded	1 Pair of Each Included: 0.039" Dia. 15°, 0.047" Dia. 15°, 0.074" Dia. 15°, 0.039" Dia. 45°, 0.047 Dia. 45°, 0.074" Dia. 45°, 0.039" Dia 90°, 0.047" Dia 90° & 0.074" 90° Angle	0.08 lb

GEARWRENCH® 6 Pc. Cam-Lock Style Convertible Snap Ring Pliers Set

- Patented Design Allows Quick Change-Over From Internal to External Ring Applications
- To Change - Push Button on Knob and Rotate
- Fits Internal and External Rings From 1/4" to 2"
- Cushion Grip Handles for Comfort
- Comes in Custom Molded Storage Case
- Includes Popular Tip Diameters



Cat. No.	UPC No.	Packaging	Includes Tips Dia./ Angle	Product Weight
3859D	082171038594	Blow Mold Case	0.038", 0.047" and 0.070" in 18° and 90° Angled" Tips	0.40 lb

GEARWRENCH® 12 Pc. Fixed Tip Combination Snap Ring Pliers Set

- Set Includes the Four Most Popular Tip Sizes
- Designed for the Removal and Installation of Either Internal Or External Snap Rings
- Features Cushion Dipped Handles for Comfort
- Set Is Packaged in a Durable Plastic Storage Case



Cat. No.	UPC No.	Packaging	Includes Tips Dia./ Angle	Product Weight
3495	082171034954	Blow Mold Case	0.038", 0.047", 0.070" and 0.090" in Straight, 45° and 90° Angle	5.15 lb

Cat. No.	Description	Cat. No.	Description
3483DD	Fixed Tip / Combination Snap Ring Pliers / 0.038 / straight	3489	Fixed Tip / Combination Snap Ring Pliers / 0.070 / straight
3484D	Fixed Tip / Combination Snap Ring Pliers / 0.038 / 45 degree	3490D	Fixed Tip / Combination Snap Ring Pliers / 0.070 / 45 degree
3485D	Fixed Tip / Combination Snap Ring Pliers / 0.038 / 90 degree	3491	Fixed Tip / Combination Snap Ring Pliers / 0.070 / 90 degree
3486	Fixed Tip / Combination Snap Ring Pliers / 0.047 / straight	3492	Fixed Tip / Combination Snap Ring Pliers / 0.090 / straight
3487	Fixed Tip / Combination Snap Ring Pliers / 0.047 / 45 degree	3493	Fixed Tip / Combination Snap Ring Pliers / 0.090 / 45 degree
3488D	Fixed Tip / Combination Snap Ring Pliers / 0.047 / 90 degree	3494	Fixed Tip / Combination Snap Ring Pliers / 0.090 / 90 degree

GEARWRENCH® Snap Ring Pliers, Fixed Tip

- Versatile, Heavy Duty Pliers Designed for the Removal and Installation of Either Internal or External Snap Rings on a Wide Range of Applications
- Feature a Cushion Dipped Handle and are Designed for Heavy Duty Use



Cat. No.	UPC No.	Packaging	Includes Tips Dia./ Angle	Product Weight
3483DD	082171034831	Bagged	0.038" Straight	0.16 lb
3484D	082171034848	Bagged	0.038" 45°	0.16 lb
3485D	082171034855	Bagged	0.038" 90°	0.16 lb
3486	082171034862	Bagged	0.047" Straight	0.16 lb
3487	082171034879	Bagged	0.047" 45°	0.16 lb
3488D	082171034886	Bagged	0.047" 90°	0.16 lb
3489	082171034893	Bagged	0.070" Straight	0.27 lb
3490D	082171034909	Bagged	0.070" 45°	0.27 lb
3491	082171034916	Bagged	0.070" 90°	0.27 lb
3492	082171034923	Bagged	0.090" Straight	0.50 lb
3493	082171034930	Bagged	0.090" 45°	0.50 lb
3494	082171034947	Bagged	0.090" 90°	0.50 lb

GEARWRENCH® Universal Convertible Retaining Ring Pliers, Small

- For Up to 1.0" Diameter Rings
- Easily Convert From Internal to External Rings By Moving Levers. No Pins to Push
- Hex Shaped Locking Guides Firmly Hold Tips
- Ergonomic Anti-Slip Sealed Air Pocket Grips for Comfort
- Spring Loaded for Faster Work
- Includes: 5 Pairs of Color Coded Tips & Hex Wrench
- Replacement Tip Set Part: 315077



Cat. No.	UPC No.	Packaging	Includes Tips Dia./ Angle	Product Weight
3150D	082171031502	Carded	0.024", 0.038", 0.038" 90°, 0.047", 0.047" 90°	0.30 lb

GEARWRENCH® Universal Convertible Retaining Ring Pliers, Large

- For Up to 2.0" Diameter Rings
- Easily Convert From Internal to External Rings By Moving Levers. No Pins to Push
- Hex Shaped Locking Guides Firmly Hold Tips
- Ergonomic Anti-Slip Sealed Air Pocket Grips for Comfort
- Spring Loaded for Faster Work
- Replacement Tip Set Part: 315177



Cat. No.	UPC No.	Packaging	Includes Tips Dia./ Angle	Product Weight
3151	082171031519	Carded	0.038", 0.038" 90°, 0.047", 0.047" 90°, 0.070"	0.60 lb

GEARWRENCH® Universal Convertible Retaining Ring Pliers, Extra Large

- For Use on Internal Rings 1-13/16" to 4" and External Rings 1-1/2" to 4"
- Easily Convert From Internal to External Use on Snap Rings With the Push-Button Feature
- Ratchet Lock Holds the Snap Ring in Desired Position
- Cushion-Grip Handles for Comfort
- Replacement Tip Set Part: 315277



Cat. No.	UPC No.	Packaging	Includes Tips Dia./ Angle	Product Weight
3152D	082171031526	Carded	0.090" 15° & 90°, 0.108" 15° & 90°, and 0.120" 15° & 90° Tips	1.20 lb



GEARWRENCH®

Ratcheting Tap & Die Sets 365

Adapters..... 368

Screw Extractors 370

Bastard Files..... 371

GEARWRENCH® Ratcheting Tap & Die

GearWrench® has taken the ratcheting wrench design and applied it to the tap and die application. The ratcheting handles and adapters allow for easy back and forth movement required while cutting threads on either taps or dies.

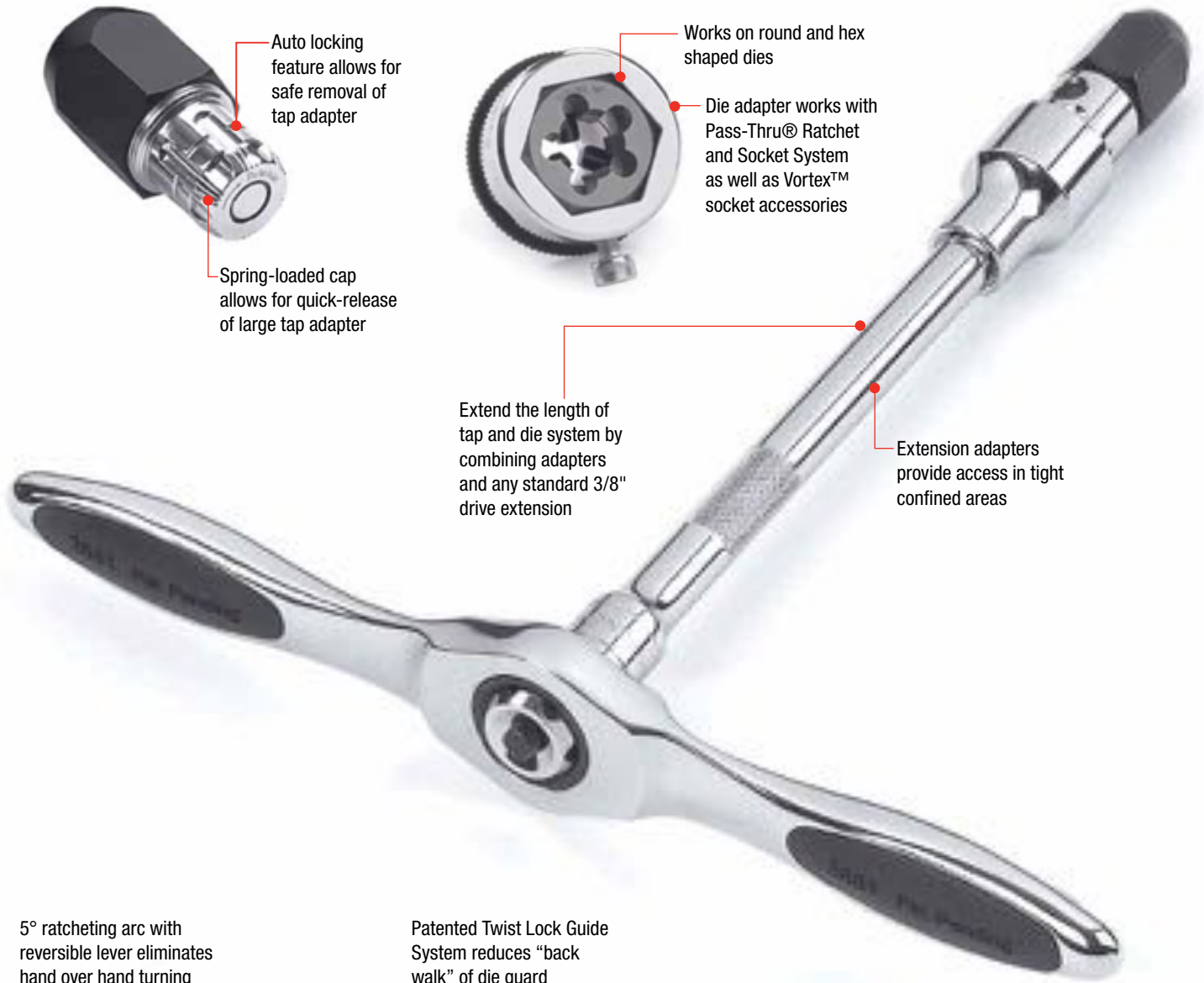

Auto locking feature allows for safe removal of tap adapter

Spring-loaded cap allows for quick-release of large tap adapter

Works on round and hex shaped dies

Die adapter works with Pass-Thru® Ratchet and Socket System as well as Vortex™ socket accessories

Extend the length of tap and die system by combining adapters and any standard 3/8" drive extension

Extension adapters provide access in tight confined areas

5° ratcheting arc with reversible lever eliminates hand over hand turning

Patented Twist Lock Guide System reduces "back walk" of die guard



Products are covered by one or more of the following patents:

- US 6,868,759
- US 7,231,851
- US 7,168,346

GEARWRENCH® 114 Pc. SAE/Metric Large Ratcheting Tap and Die Drive Tool Set

- Die adapter works on round and hex shaped dies
- 5 degree ratcheting arc with reversible lever eliminates hand over hand turning
- Patented Twist Lock Guide System reduces "back walk" of die guard
- Die adapter works with Pass-Thru® Ratchet and Socket System as well as Vortex™ socket accessories
- Autolocking feature allows for safe removal of tap adapter
- Spring-loaded cap allows for quick-release of large tap adapter
- Extension adapters provide access in tight confined areas



Cat. No.	UPC No.	Packaging		Product Weight			
82812	099575828126	Case		18.25 lb			
Cat. No.	Description	Cat. No.	Description	Cat. No.	Description	Cat. No.	Description
82800	Large Ratcheting Sliding "T" Wrench	-	Tap 3/8 - 16 NC plug	-	Tap 14 x 1.25 plug	-	Hex Die 5/8 - 11 NC plug
82801	Large Locking Tap Adapter	-	Tap 3/8 - 24 NF plug	-	Tap 14 x 2.00 plug	-	Hex Die 5/8 - 18 NF plug
82802D	Hex Die Adapter	-	Tap 7/16 - 14 NC plug	-	Tap 16 x 1.50 plug	-	Hex Die 3/4 - 10 NC plug
3881	Medium Ratcheting Sliding "T" Wrench	-	Tap 7/16 - 20 NF plug	-	Tap 16 x 2.00 plug	-	Hex Die 3/4 - 16 NF plug
3883	Medium Tap Adapter	-	Tap 1/2 - 13 NC plug	-	Tap 18 x 1.50 plug	-	Hex Die 3 x 0.50 taper
3882	Small Tap Adapter	-	Tap 1/2 - 20 NF plug	-	Tap 18 x 2.50 plug	-	Hex Die 3 x 0.60 taper
3884D	Medium Hex Die Adapter	-	Tap 9/16 - 12 NC plug	-	Hex Die 4 - 40 taper	-	Hex Die 4 x 0.70 taper
82803D	Male Extension Adapter - 3/8" Drive	-	Tap 9/16 - 18 NF plug	-	Hex Die 6 - 32 taper	-	Hex Die 4 x 0.75 taper
82804	Female Extension Adapter - 3/8" Drive	-	Tap 5/8 - 11 NC plug	-	Hex Die 8 - 32 taper	-	Hex Die 5 x 0.80 taper
-	Sliding "T" for Adapters	-	Tap 5/8 - 18 NF plug	-	Hex Die 10 - 24 taper	-	Hex Die 5 x 0.90 taper
-	4mm Hex Key	-	Tap 3/4 - 10 NC plug	-	Hex Die 10 - 32 taper	-	Hex Die 6 x 1.00 taper
-	5 Screw Extractors	-	Tap 3/4 - 16 NF plug	-	Hex Die 12 - 24 taper	-	Hex Die 7 x 1.00 taper
-	Metric Thread Gauge	-	Tap 3 x 0.50 taper	-	Hex Die 1/8 - 27 NPT	-	Hex Die 8 x 1.25 plug
-	SAE Thread Gauge	-	Tap 3 x 0.60 taper	-	Hex Die 1/8 - 28 BSP	-	Hex Die 9 x 1.00 plug
-	Tap 4 - 40 taper	-	Tap 4 x 0.70 taper	-	Hex Die 1/4 - 18 NPT	-	Hex Die 9 x 1.25 plug
-	Tap 6 - 32 taper	-	Tap 4 x 0.75 taper	-	Hex Die 1/4 - 19 BSP	-	Hex Die 10 x 1.25 plug
-	Tap 8 - 32 taper	-	Tap 5 x 0.80 taper	-	Hex Die 1/4 - 20 NC taper	-	Hex Die 10 x 1.50 plug
-	Tap 10 - 24 taper	-	Tap 5 x 0.90 taper	-	Hex Die 1/4 - 28 NF taper	-	Hex Die 11 x 1.50 plug
-	Tap 10 - 32 taper	-	Tap 6 x 0.100 taper	-	Hex Die 5/16 - 18 NC taper	-	Hex Die 12 x 1.50 plug
-	Tap 12 - 24 taper	-	Tap 7 x 1.00 taper	-	Hex Die 5/16 - 24 NF taper	-	Hex Die 12 x 1.75 plug
-	Tap 1/8 - 27 NTP	-	Tap 8 x 1.25 plug	-	Hex Die 3/8 - 16 NC plug	-	Hex Die 14 x 1.25 plug
-	Tap 1/8 - 28 BSP	-	Tap 9 x 1.00 plug	-	Hex Die 3/8 - 24 NF plug	-	Hex Die 14 x 2.00 plug
-	Tap 1/4 - 18 NPT	-	Tap 9 x 1.25 plug	-	Hex Die 7/16 - 14 NC plug	-	Hex Die 16 x 1.50 plug
-	Tap 1/4 - 19 BSP	-	Tap 10 x 1.25 plug	-	Hex Die 7/16 - 20 NF plug	-	Hex Die 16 x 2.00 plug
-	Tap 1/4 - 20 NC taper	-	Tap 10 x 1.50 plug	-	Hex Die 1/2 - 13 NC plug	-	Hex Die 18 x 1.50 plug
-	Tap 1/4 - 28 NF taper	-	Tap 11 x 1.50 plug	-	Hex Die 1/2 - 20 NF plug	-	Hex Die 18 x 2.50 plug
-	Tap 5/16 - 18 NC taper	-	Tap 12 x 1.50 plug	-	Hex Die 9/16 - 12 NC plug	-	
-	Tap 5/16 - 24 NF plug	-	Tap 12 x 1.75 plug	-	Hex Die 9/16 - 18 NF plug	-	

GEARWRENCH® 75 Pc. SAE/Metric Medium Ratcheting Tap and Die Drive Tool Set

- Die adapter works on round and hex shaped dies
- 5 degree ratcheting arc with reversible lever eliminates hand over hand turning
- Patented Twist Lock Guide System reduces "back walk" of die guard
- Die adapter works with Pass-Thru® Ratchet and Socket System as well as Vortex™ socket accessories
- Autolocking feature allows for safe removal of tap adapter
- Spring-loaded cap allows for quick-release of large tap adapter
- Extension adapters provide access in tight confined areas



Cat. No.	UPC No.	Packaging	Product Weight
3887	082171388736	Case	7.22 lb

Cat. No.	Description	Cat. No.	Description	Cat. No.	Description	Cat. No.	Description
3881	Medium Ratcheting Sliding "T" Wrench	-	Tap 1/4 - 28 NF taper	-	Tap 5 x 0.80 taper	-	Hex Die 6 - 32 taper
3882	Small Tap Adapter	-	Tap 5/16 - 18 NC taper	-	Tap 5 x 0.90 taper	-	Hex Die 8 - 32 taper
3883	Medium Tap Adapter	-	Tap 5/16 - 24 NF plug	-	Tap 6 x 0.100 taper	-	Hex Die 10 - 24 taper
3884D	Medium Hex Die Adapter	-	Tap 3/8 - 16 NC plug	-	Tap 7 x 1.00 taper	-	Hex Die 10 - 32 taper
-	Sliding "T" for Adapters	-	Tap 3/8 - 24 NF plug	-	Tap 8 x 1.25 plug	-	Hex Die 12 - 24 taper
-	SAE screw pitch gauge	-	Tap 7/16 - 14 NC plug	-	Tap 9 x 1.00 plug	-	Hex Die 1/4 - 20 NC taper
-	METRIC screw pitch gauge	-	Tap 7/16 - 20 NF plug	-	Tap 9 x 1.25 plug	-	Hex Die 1/4 - 28 NF taper
-	#5 screwdriver	-	Tap 1/2 - 13 NC plug	-	Tap 10 x 1.25 plug	-	Hex Die 5/16 - 18 NC taper
-	Tap 4 - 40 taper	-	Tap 1/2 - 20 NF plug	-	Tap 10 x 1.50 plug	-	Hex Die 5/16 - 24 NF taper
-	Tap 6 - 32 taper	-	Tap 9/16 - 12 NC plug	-	Tap 11 x 1.50 plug	-	Hex Die 3/8 - 16 NC plug
-	Tap 8 - 32 taper	-	Tap 9/16 - 18 NF plug	-	Tap 12 x 1.50 plug	-	Hex Die 3/8 - 24 NF plug
-	Tap 10 - 24 taper	-	Tap 5/8 - 11 NC plug	-	Tap 12 x 1.75 plug	-	Hex Die 7/16 - 14 NC plug
-	Tap 10 - 32 taper	-	Tap 5/8 - 18 NF plug	-	Tap 14 x 1.25 plug	-	Hex Die 7/16 - 20 NF plug
-	Tap 12 - 24 taper	-	Tap 3/4 - 10 NC plug	-	Tap 14 x 2.00 plug	-	Hex Die 1/2 - 13 NC plug
-	Tap 1/8 - 27 NTP	-	Tap 3/4 - 16 NF plug	-	Tap 16 x 1.50 plug	-	Hex Die 1/2 - 20 NF plug
-	Tap 1/8 - 28 BSP	-	Tap 3 x 0.50 taper	-	Tap 16 x 2.00 plug	-	Hex Die 9/16 - 12 NC plug
-	Tap 1/4 - 18 NPT	-	Tap 3 x 0.60 taper	-	Tap 18 x 1.50 plug	-	Hex Die 9/16 - 18 NF plug
-	Tap 1/4 - 19 BSP	-	Tap 4 x 0.70 taper	-	Tap 18 x 2.50 plug	-	Hex Die 5/8 - 11 NC plug
-	Tap 1/4 - 20 NC taper	-	Tap 4 x 0.75 taper	-	Hex Die 4 - 40 taper	-	Hex Die 5/8 - 18 NF plug

GEARWRENCH® 40 Pc. SAE Medium Ratcheting Tap and Die Drive Tool Set

- Die adapter works on round and hex shaped dies
- 5 degree ratcheting arc with reversible lever eliminates hand over hand turning
- Patented Twist Lock Guide System reduces "back walk" of die guard
- Die adapter works with Pass-Thru® Ratchet and Socket System as well as Vortex™ socket accessories
- Autolocking feature allows for safe removal of tap adapter
- Spring-loaded cap allows for quick-release of large tap adapter
- Extension adapters provide access in tight confined areas



Cat. No.	UPC No.	Packaging	Product Weight
3885	082171388514	Case	4.55 lb

Cat. No.	Description	Cat. No.	Description	Cat. No.	Description	Cat. No.	Description
3881	Medium Ratcheting Sliding "T" Wrench	-	Tap 10 - 32 taper	-	Tap 1/2 - 13 NC plug	-	Hex Die 5/16 - 18 NC
3882	Small Tap Adapter	-	Tap 12 - 24 taper	-	Tap 1/2 - 20 NF plug	-	Hex Die 5/16 - 24 NF
3883	Medium Tap Adapter	-	Tap 1/8 - 27 NPT	-	Hex Die 4 - 40 taper	-	Hex Die 3/8 - 16 NC
3884D	Medium Hex Die Adapter	-	Tap 1/4 - 20 NC	-	Hex Die 6 - 32 taper	-	Hex Die 3/8 - 24 NF
-	Sliding "T" for Adapters	-	Tap 1/4 - 28 NF taper	-	Hex Die 8 - 32 taper	-	Hex Die 7/16 -14 NC
-	Thread gauge	-	Tap 5/16 - 18 NC taper	-	Hex Die 10 - 24 taper	-	Hex Die 7/16 - 20 NF
-	#5 screwdriver	-	Tap 5/16 24 NF taper	-	Hex Die 10 - 32 taper	-	Hex Die 1/2 -13 NC
-	Tap 4 - 40 taper	-	Tap 3/8 - 16 NC plug	-	Hex Die 12 - 24 taper	-	Hex Die 1/2 - 20 NF
-	Tap 6 - 32 taper	-	Tap 3/8 - 24 NF plug	-	Hex Die 1/8 - 27 NPT	-	
-	Tap 8 - 32 taper	-	Tap 7/16 -14 NC plug	-	Hex Die 1/4 - 20 NC	-	
-	Tap 10 - 24 taper	-	Tap 7/16 - 20 NF plug	-	Hex Die 1/4 - 28 NF	-	

GEARWRENCH® 40 Pc. Metric Medium Ratcheting Tap and Die Drive Tool Set

- Die adapter works on round and hex shaped dies
- 5 degree ratcheting arc with reversible lever eliminates hand over hand turning
- Patented Twist Lock Guide System reduces "back walk" of die guard
- Die adapter works with Pass-Thru® Ratchet and Socket System as well as Vortex™ socket accessories
- Autolocking feature allows for safe removal of tap adapter
- Spring-loaded cap allows for quick-release of large tap adapter
- Extension adapters provide access in tight confined areas



Cat. No.	UPC No.	Packaging	Product Weight
3886	082171388620	Case	4.47 lb

Cat. No.	Description	Cat. No.	Description	Cat. No.	Description	Cat. No.	Description
3881	Medium Ratcheting Sliding "T" Wrench	-	Tap 4 x 0.75 taper	-	Tap 11 x 1.50 plug	-	Hex Die 8 x 1.25
3882	Small Tap Adapter	-	Tap 5 x 0.80 taper	-	Tap 12 x 1.50 plug	-	Hex Die 9 x 1.00
3883	Medium Tap Adapter	-	Tap 5 x 0.90 taper	-	Tap 12 x 1.75 plug	-	Hex Die 9 x 1.25
3884D	Medium Hex Die Adapter	-	Tap 6 x 1.00 taper	-	Hex Die 3 x 0.60	-	Hex Die 10 x 1.25
-	#5 screwdriver	-	Tap 7 x 1.00 taper	-	Hex Die 4 x 0.70	-	Hex Die 10 x 1.50
-	Sliding "T" for Adapters	-	Tap 8 x 1.25 plug	-	Hex Die 4 x 0.75	-	Hex Die 11 x 1.50
-	Thread gauge	-	Tap 9 x 1.00 plug	-	Hex Die 5 x 0.80	-	Hex Die 12 x 1.50
-	Tap 3 x 0.50 taper	-	Tap 9 x 1.25 plug	-	Hex Die 5 x 0.90	-	Hex Die 12 x 1.75
-	Tap 3 x 0.60 taper	-	Tap 10 x 1.25 plug	-	Hex Die 6 x 1.00	-	Hex Die 1/8 - 28BSP
-	Tap 4 x 0.70 taper	-	Tap 10 x 1.50 plug	-	Hex Die 7 x 1.00	-	

GEARWRENCH® 5 Pc. Medium Ratcheting Tap and Die Drive Tool Set

- Die adapter works on round and hex shaped dies
- 5 degree ratcheting arc with reversible lever eliminates hand over hand turning
- Patented Twist Lock Guide System reduces "back walk" of die guard
- Die adapter works with Pass-Thru® Ratchet and Socket System as well as Vortex™ socket accessories
- Autolocking feature allows for safe removal of tap adapter
- Spring-loaded cap allows for quick-release of large tap adapter
- Extension adapters provide access in tight confined areas



Cat. No.	UPC No.	Packaging	Product Weight
3880	082171388040	Case	2.65 lb

Cat. No.	Description	Cat. No.	Description
3881	Medium Ratcheting Sliding "T" Wrench	3884D	Medium Hex Die Adapter
3882	Small Tap Adapter	-	Sliding "T" for Adapters
3883	Medium Tap Adapter		

GEARWRENCH® Ratcheting "T" Wrench

- 5 degree ratcheting arc with reversible lever eliminates hand over hand turning
- Patented Twist Lock Guide System reduces "Back Walk" of die guard
- 3881: Works with 3882 and 3883 Tap Adapters & 3884 Die Adapter
- 82800: Works with 82801 Tap Adapter & 82802 Die Adapter



Cat. No.	UPC No.	Packaging	Size	Product Weight
3881	082171388156	Carded	Medium	1.00 lb
82800	099575828003	Carded	Large	1.55 lb

GEARWRENCH® Tap Adapters

- Designed for use with the GearRatchet™ System
- 3882 Tap Adapter Fits Tap Shanks with Size Ranges from 0.110" to 0.191"
- 3883 Tap Adapter Fits Tap Shanks with Size Ranges from 0.219" to 0.280"

Cat. No.	UPC No.	Packaging	Product Weight
3882	082171388248	Carded	0.50 lb
3883	082171388361	Carded	0.50 lb



GEARWRENCH® Large Locking Tap Adapter

- Auto locking feature allows for safe removal of tap adapter
- Spring loaded cap allows for quick-release of large tap adapter
- Accommodates taps up to 9/16"-3/4" and 14mm-18mm

Cat. No.	UPC No.	Packaging	Product Weight
82801	099575828010	Carded	1.17 lb



GEARWRENCH® Hex Die Adapter

- Die adapter works with Pass-Thru® Ratchet and Socket System as well as Vortex™ socket accessories
- Works on round and hex shaped dies
- 3884D fits 1" Diameter Hex Stock and will Work with Round Stock as Well
- 82802 Fits Up to 1-7/16" Diameter Hex Stock and Hex Dies Sizes 9/16" to 3/4"



Cat. No.	UPC No.	Packaging	Product Weight
3884D	082171388446	Carded	0.50 lb
82802D	099575828027	Carded	0.61 lb

GEARWRENCH® Extension Adapters

Cat. No.	UPC No.	Description	Product Weight
82803D	099575828034	Male Extension Adapter - 3/8" Drive	0.11 lb
82804	099575828041	Female Extension Adapter - 3/8" Drive	0.57 lb



GEARWRENCH® External Thread Restorer Files

- Restore External Threads by Filing
- Overlap Several Good Threads with File then File Damaged Threads
- Files Both Right and Left-Hand Threads
- Features Long-Lasting, Fast-Cutting Teeth



Cat. No.	UPC No.	Packaging	Description	Product Weight
2228D	082171022289	Carded	Metric External Thread Restorer File, Pitch (0.75, 1.00, 1.25, 1.50, 1.75, 2.00, 2.50, 3.00mm)	0.35 lb
2229D	082171022296	Carded	SAE External Thread Restorer File, Pitch (11, 12, 13, 14, 16, 18, 20, 24)	0.35 lb
2249D	082171022494	Carded	SAE External Thread Restorer File, Pitch (9, 10, 12, 16, 20, 27, 28, 32)	0.36 lb

GEARWRENCH® 6 Pc. 3/8" Drive Impact Driver Set

- Free Frozen Bolts and Screws by Twisting the Tool in the Direction of the Rotation and Holding while Striking with a Hammer
- Reverse Action to Tighten Bolts
- Set is Standard 3/8" Square Drive and includes a 3/8" Square Drive Adapter for 5/16" Hex Bits
- Four-bit Set includes No. 2 and No. 3 Phillips Bits and 5/16" and 9/32" Slotted Bits



Cat. No.	UPC No.	Packaging	Description	Product Weight
1140D	082171011405	Carded	6 Pc. 3/8" Drive Impact Driver Set	1.53 lb
412402	082171412424	Bagged	No. 2 Phillips Insert Bit 5/16" Dr.	0.05 lb
412403	082171412400	Bagged	Replacement No. 3 Phillips Insert Bit 5/16" Dr.	0.01 lb
412406	082171412462	Bagged	Replacement 6-8 Slotted Insert Bit 5/16" Dr.	0.01 lb
412410	082171412417	Bagged	Replacement 8-10 Slotted Insert Bit 5/16" Dr.	0.01 lb

GEARWRENCH® 5 Pc. Screw Extractor Set

- Removes Broken Studs, Set Screws, Pipe and Alemite Fittings
- Drill a Hole in the Screw and Place Extractor into Hole
- Tap Lightly with a Hammer and Turn Counterclockwise with a Tap Wrench to Remove the Screw
- Features Undercut Flutes for More Positive Grip



Cat. No.	UPC No.	Packaging	Product Weight
720DD	082171007200	Carded	0.30 lb

Cat. No.	Description	Cat. No.	Description
1109D	Screw Extractor (Sizes 1/4", 5/16")	1112D	Screw Extractor (Sizes 1/2", 9/16")
1110D	Screw Extractor (Size 3/8")	1113DD	Screw Extractor (Size 5/8")
1111D	Screw Extractor (Size 7/16")		

GEARWRENCH® Screw Extractors

- Removes Broken Studs, Set Screws, Pipe and Alemite Fittings
- Drill a Hole in the Screw and Place Extractor into Hole
- Tap Lightly with a Hammer and Turn Counterclockwise with a Tap Wrench to Remove the Screw
- Features Undercut Flutes for More Positive Grip



Cat. No.	UPC No.	Packaging	For Use on Screw Sizes	For Use on Pipe Sizes	Use Drill Size	Minimum Depth of Drilled Hole	Product Weight
1109D	082171011092	Bagged	1/4 in; 5/16 in	-	1/8 in	3/8 in	0.05 lb
1110D	082171011108	Bagged	3/8 in	-	3/16 in	1/2 in	0.05 lb
1111D	082171011115	Bagged	7/16 in	1/8 in	15/64 in	1/2 in	0.10 lb
1112D	082171011122	Bagged	1/2 in; 9/16 in	1/4 in	5/16 in	1/2 in	0.17 lb
1113DD	082171011139	Bagged	5/8 in	3/8 in	3/8 in	5/8 in	0.20 lb

GEARWRENCH® 4 Pc. Spiral Screw Extractor Set

- Removes Screws, Broken Studs, Set Screws, Pipe and Alemite Fittings
- Drill a Hole in the Screw and Place Extractor Into Hole
- Tap Lightly With Hammer and Turn Counterclockwise With Tap Wrench to Remove the Screw
- Spiral Blades Grip Screw



Cat. No.	UPC No.	Packaging	For Use on Screw Sizes	Use Drill Size	Product Weight
2419D	082171024191	Carded	No. 12 to 5/16"; 5/16" to 7/16"; 7/16" to 9/16"; 9/16" to 3/4";	7/64 in 5/32 in 1/4 in 17/64 in	0.25 lb

GEARWRENCH® Universal Nut Cracker

- Splits Most Stubborn Nuts 7/16" (11mm) Through 3/4" (19mm) Across the Flats
- Works in Channels Not Accessible to Other Tools
- Parallel Action of Pusher Cracks Nuts Without Damaging Bolt Threads
- Chisel Rotates 360° to Line Up Parallel to Bolt
- Simply Tighten the Screw Until the Nut Splits Has Rugged Drop-Forged Frame
- Do Not Use on Heat-Treated Nuts
- Length: 6-3/4"
- This is a Serviceable Product



Cat. No.	UPC No.	Packaging	Description	Product Weight
715D	082171007156	Carded	Universal Nut Cracker	1.50 lb
71575D	082171715754	Bagged	Replacement Plunger	0.05 lb
71574	082171715747	Bagged	Replacement Chisel	0.25 lb
71573D	082171715730	Bagged	Replacement Ball Bearings	0.01 lb

GEARWRENCH® 4 Pc. Standard Bastard File Set

- Set Comprised of the 4 Most Common File Shapes
- Ergonomic Dual Material Handle



Cat. No.	UPC No.	Packaging	Product Weight
82820	099575828201	Tray	2.22 lb

Cat. No.	Description	Cat. No.	Description
82822D	8" Flat Bastard File	82824	8" Half Round Bastard File
82823	8" Round Bastard File	82825	8" Triangle Bastard File

GEARWRENCH® 6 Pc. Mini Bastard File Set

- 4" Mini Files in an Assortment of Shapes
- Ergonomic Dual Material Handle



Cat. No.	UPC No.	Packaging	Handled	Product Weight
82821	099575828218	Pouch	Ergonomic	0.79 lb

Cat. No.	Description	Cat. No.	Description
-	4" Flat Mini File	-	4" Round Mini File
-	4" Half Round Mini File	-	4" Square Mini File
-	4" Knife Mini File	-	4" Triangle Mini File

GEARWRENCH® Flat Bastard File

- Efficient File for Removing Flash and Other Particles
- Ergonomic Dual Material Handle



Cat. No.	UPC No.	Packaging	Length	File Cut	Product Weight
82822D	099575828225	Bagged	8 in	Bastard	0.46 lb

GEARWRENCH® Round Bastard File

- For Enlarging Curved or Round Openings
- Ergonomic Dual Material Handle



Cat. No.	UPC No.	Packaging	Length	File Cut	Product Weight
82823	099575828232	Bagged	8 in	Bastard	0.30 lb

GEARWRENCH® Half Round Bastard File

- Provides Spiral Cut for Smooth Finish
- Curved on One Side and Flat on the Other
- Ergonomic Dual Material Handle



Cat. No.	UPC No.	Packaging	Length	File Cut	Product Weight
82824	099575828249	Bagged	8 in	Bastard	0.45 lb

GEARWRENCH® Triangle Bastard File

- Used for Cutting and Cleaning Corners
- Ergonomic Dual Material Handle



Cat. No.	UPC No.	Packaging	Length	File Cut	Product Weight
82825	099575828256	Bagged	8 in	Bastard	0.45 lb



GEARWRENCH®

Hammers & Sets	375
Punch & Chisel Sets	377
Chisels.....	379
Punches	380

GEARWRENCH® Striking & Struck

GearWrench® striking and struck tools offer performance features that outperform other brands. Hammers and chisels are designed for long life and with safety in mind. Precision ground surfaces provide better visibility and ease of use.

HAMMERS



AVAILABLE IN SETS



Fully polished head

Epoxy-bonded head

Fiberglass handle

Laser etched logo and size

Forged alloy steel head

Molded-on rubber grip

PUNCHES & CHISELS



Hardened Tips

Precision Hardened Alloy Steel

Surface ground for easy size identification

Softened striking surface

AVAILABLE IN SETS

GEARWRENCH® Hammer Set

- Popular starter set of Hammers and mallets
- Soft face, Rubber Mallet, Drilling Hammer and Ball Pein
- Precision Hardened Striking Face
- Durable Storage Tray
- Fiberglass Handle
- Molded Comfort Grip Handle
- 5-Piece Hammer Set



Cat. No.	UPC No.	Product Weight
82303	099575823039	11.53 lb

Cat. No.	Description	Cat. No.	Description
82251	16 oz Ball Pein Hammer - Fiberglass	82259	16 oz Rubber Mallet - Wood Hickory Handle
82255	3 lb Drilling Hammer	82260	12 oz Soft Face Hammer, Removable Caps
82256	16 oz Dead Blow Hammer - Composite Handle		

GEARWRENCH® Ball Pein Hammers

- Comfortable Black Cushion Grip
- Dropped Forged Head From Alloy Steel Finished in Black with Polished Face, Cheeks, and Pein
- Meets or Exceeds ASME B107.400-2008



Cat. No.	UPC No.	Packaging	Head Weight (Ounces)	Head Weight (Pounds)	Length	Face Finish	Product Weight
82250	099575822506	Bulk	8.0 oz	0.5 lb	11.8 in	Polished	0.80 lb
82251	099575822513	Bulk	16.0 oz	1.0 lb	13.7 in	Polished	1.50 lb
82252	099575822520	Bulk	24.0 oz	1.5 lb	15.59 in	Polished	2.19 lb
82253	099575822537	Bulk	32.0 oz	1.9 lb	15.74 in	Polished	2.62 lb

GEARWRENCH® Curved Claw Hammer - Fiberglass

- For Driving Nails
- All Types of General Construction
- Not for Punches and Chisels



Cat. No.	UPC No.	Packaging	Head Weight (Ounces)	Length	Face Finish	Product Weight
82254	099575822544	Bulk	16 oz	12.87 in	Polished	12.75 lb

GEARWRENCH® Drilling Hammer

- Heavy Duty Uses with Punches, Chisels, and Star Drills



Cat. No.	UPC No.	Packaging	Head Weight (Ounces)	Head Weight (Pounds)	Length	Face Diameter	Product Weight
82255	099575822551	Bulk	48 oz	3 lb	10.51 in	1.38 in	3.52 lb

GEARWRENCH® Engineer's Hammer

- Forged Steel Alloy Head
- Fully Polished Face
- Precision Hardened Striking Face
- Fiberglass Handle
- Comfort Grip Handle
- Meets or Exceeds ASME B107.54



Cat. No.	UPC No.	Packaging	Head Weight (Ounces)	Head Weight (Pounds)	Length	Face Diameter	Product Weight
82289	099575822896	Bulk	48 oz	3 lb	10.31 in	1.09 in	3.73 lb

GEARWRENCH® Dead Blow Hammers

- Composite Handle
- Assembly, Maintenance, Production Applications



Cat. No.	UPC No.	Packaging	Head Weight (Ounces)	Head Length	Face Diameter	Face Finish	Product Weight
82256	099575822568	Bulk	16 oz	3.5 in	1.6 in	Composite	1.13 lb
82257	099575822575	Bulk	32 oz	4.3 in	2.0 in	Composite	2.12 lb
82258	099575822582	Bulk	48 oz	5.0 in	2.4 in	Composite	3.05 lb

GEARWRENCH® Rubber Mallet - Wood Hickory Handle

- Solid Hickory Handle



Cat. No.	UPC No.	Packaging	Head Weight (Ounces)	Weight Class	Product Weight
82259	099575822599	Bulk	16 oz	16	1.22 lb

GEARWRENCH® Soft Face Hammer

- Light Assembly Applications
- Comfortable Black Cushion Grip



Cat. No.	UPC No.	Packaging	Head Weight (Ounces)	Weight Class	Head Length	Thread Size	Handle Length	Product Weight
82260	099575822605	Bulk	12 oz	12	4 in	5/16-18	11 in	1.11 lb

GEARWRENCH® Body Tool Set

- General Body Tool and Dolly Set
- Hickory Handles
- Fine Polished Surfaces on Dollies
- Soft and Cross Faced Striking Surfaces
- Includes a Storage Case



Cat. No.	UPC No.	Packaging	Product Weight
82302	099575823022	Carry Case	12.35 lb

Cat. No.	Description	Cat. No.	Description
-	Smooth Faced Bumping Hammer W/ Square & Round Face	-	Toe Dolly
-	Smooth Faced Cross Chisel Hammer	-	Wedge Dolly
-	Crossed Face Shrinking Hammer	-	Heel Dolly
-	General Purpose Dolly		

GEARWRENCH® 27 Pc. Punch and Chisel Set

- Chisel for Cutting Rivets, Bolts, and Nuts
- Pin Punch for Final Removal to Drive Out Pins and Rivets
- Center Punch for Marking Center Lines and Pilot Drill Locations
- Long Taper Punch to Install and Remove Pins and Shafts and to Align Holes
- Starter Punch for Both Starting and Installing Pins and Rivets



Cat. No.	UPC No.	Packaging	Product Weight
82306	099575823060	Bagged	9.29 lb

Cat. No.	Description	Cat. No.	Description
82261	1/4" x 4-3/4" x 1/4" Cold Chisel	82275	3/16" x 5-1/2" x 5/16" Pin Punch
82262	3/8" x 5" x 5/16" Cold Chisel	82276	1/4" x 7" x 3/8" Pin Punch
82263	7/16" x 5-1/2" x 3/8" Cold Chisel	82277	5/16" x 7" x 1/2" Pin Punch
82264	1/2" x 6" x 3/8" Cold Chisel	82278	1/8" x 8" x 3/8" Long Taper Punch
82265	5/8" x 6-1/2" x 3/8" Cold Chisel	82279	5/32" x 8-1/2" x 1/2" Long Taper
82266	3/4" x 7" x 5/8" Cold Chisel	82280	3/16" x 9" x 1/2" Long Taper Punch
82267	7/8" x 7-1/2" x 3/4" Cold Chisel	82281	1/4" x 11" x 5/8" Long Taper Punch
82268	1" x 8" x 7/8" Cold Chisel	82282	5/32" x 5" x 3/8" Starter Punch
82269	1/4" x 4-1/4" Center Punch	82283	3/16" x 5" x 3/8" Starter Punch
82270	3/8" x 5" Center Punch	82284	1/4" x 6" x 1/2" Starter Punch
82271	7/16" x 5-1/2" Center Punch	82285	1/8" x 4-1/2" x 5/16" Starter
82272	3/32" x 4-3/4" x 5/16" Pin Punch	82286	5/16" x 7" x 5/8" Starter Punch
82273	1/8" x 5" x 5/16" Pin Punch	82287	3/8" x 8" x 3/4" Starter Punch
82274	5/32" x 5-1/4" x 5/16" Pin Punch		

GEARWRENCH® 12 Pc. Punch and Chisel Set

- Chisel for Cutting Rivets, Bolts, and Nuts
- Pin Punch for Final Removal to Drive Out Pins and Rivets
- Center Punch for Marking Center Lines and Pilot Drill Locations
- Long Taper Punch to Install and Remove Pins and Shafts and to Align Holes
- Starter Punch for Both Starting and Installing Pins and Rivets



Cat. No.	UPC No.	Packaging	Product Weight
82305	099575823053	Bagged	1.97 lb

Cat. No.	Description	Cat. No.	Description
82261	1/4" x 4-3/4" x 1/4" Cold Chisel	82273	1/8" x 5" x 5/16" Pin Punch
82262	3/8" x 5" x 5/16" Cold Chisel	82274	5/32" x 5-1/4" x 5/16" Pin Punch
82264	1/2" x 6" x 3/8" Cold Chisel	82275	3/16" x 5-1/2" x 5/16" Pin Punch
82265	5/8" x 6-1/2" x 3/8" Cold Chisel	82278	1/8" x 8" x 3/8" Long Taper Punch
82270	3/8" x 5" Center Punch	82283	3/16" x 5" x 3/8" Starter Punch
82272	3/32" x 4-3/4" x 5/16" Pin Punch	82285	1/8" x 4-1/2" x 5/16" Starter

GEARWRENCH® 5 Pc. Punch and Chisel Set

- Chisel for Cutting Rivets, Bolts, and Nuts
- Pin Punch for Final Removal to Drive Out Pins and Rivets
- Center Punch for Marking Center Lines and Pilot Drill Locations



Cat. No.	UPC No.	Packaging	Product Weight
82304	099575823046	Bagged	0.61 lb

Cat. No.	Description	Cat. No.	Description
82264	1/2" x 6" x 3/8" Cold Chisel	82274	5/32" x 5-1/4" x 5/16" Pin Punch
82270	3/8" x 5" Center Punch	82275	3/16" x 5-1/2" x 5/16" Pin Punch
82273	1/8" x 5" x 5/16" Pin Punch		

GEARWRENCH® 4 Pc. Cold Chisel Set

- Designed to Cut Metal Such As Wrought Iron, Steel, Brass, and Aluminum
- For Cutting Rivets, Bolts, and Nuts



Cat. No.	UPC No.	Packaging	Product Weight
82308	099575823084	Bagged	1.35 lb

Cat. No.	Description	Cat. No.	Description
82263	7/16" x 5-1/2" x 3/8" Cold Chisel	82265	5/8" x 6-1/2" x 3/8" Cold Chisel
82264	1/2" x 6" x 3/8" Cold Chisel	82266	3/4" x 7" x 5/8" Cold Chisel

GEARWRENCH® 5 Pc. Pin Punch Set

- Used For Final Removal to Drive out Pins and Rivets
- Softened and Tapered Striking end reduces potential to chip
- Ground surface for ease of identification
- Precision Hardened working ends



Cat. No.	UPC No.	Packaging	Product Weight
82309	099575823091	Bagged	0.78 lb

Cat. No.	Description	Cat. No.	Description
82273	1/8" x 5" x 5/16" Pin Punch	82276	1/4" x 7" x 3/8" Pin Punch
82274	5/32" x 5-1/4" x 5/16" Pin Punch	82277	5/16" x 7" x 1/2" Pin Punch
82275	3/16" x 5-1/2" x 5/16" Pin Punch		

GEARWRENCH® 4 Pc. Long Taper Punch Set

- Used to Install and Remove Pins and Shafts and to Align Holes



Cat. No.	UPC No.	Packaging	Product Weight
82307	099575823077	Bagged	1.72 lb

Cat. No.	Description	Cat. No.	Description
82278	1/8" x 8" x 3/8" Long Taper Punch	82280	3/16" x 9" x 1/2" Long Taper Punch
82279	5/32" x 8-1/2" x 1/2" Long Taper	82281	1/4" x 11" x 5/8" Long Taper Punch

GEARWRENCH® Cold Chisels

- Designed to Cut Metal Such As Wrought Iron, Steel, Brass, and Aluminum
- For Cutting Rivets, Bolts, and Nuts
- Meets or Exceeds ASME B107.47



Cat. No.	UPC No.	Packaging	Width of Cut	Stock Size	Overall Length	Product Weight
82261	099575822612	Bagged	1/4 in	1/4 in	4-3/4 in	0.08 lb
82262	099575822629	Bagged	3/8 in	5/16 in	5 in	0.13 lb
82263	099575822636	Bagged	7/16 in	3/8 in	5-1/2 in	0.18 lb
82264	099575822643	Bagged	1/2 in	3/8 in	6 in	0.20 lb
82265	099575822650	Bagged	5/8 in	3/8 in	6-1/2 in	0.36 lb
82266	099575822667	Bagged	3/4 in	5/8 in	7 in	0.60 lb
82267	099575822674	Bagged	7/8 in	3/4 in	7-1/2 in	0.91 lb
82268	099575822681	Bagged	1 in	7/8 in	8 in	1.29 lb

GEARWRENCH® Center Punches

- Used for Marking Center Lines and Pilot Drill Locations
- Meets or Exceeds ASME B107.47



Cat. No.	UPC No.	Packaging	Stock Size	Overall Length	Product Weight
82269	099575822698	Bagged	1/4 in	4-1/4 in	0.06 lb
82270	099575822704	Bagged	3/8 in	5 in	0.13 lb
82271	099575822711	Bagged	7/16 in	5-1/2 in	0.20 lb

GEARWRENCH® Pin Punches

- Used for Final Removal to Drive Out Pins and Rivets
- Meets or Exceeds ASME B107.47



Cat. No.	UPC No.	Packaging	Point Diameter	Stock Size	Overall Length	Product Weight
82272	099575822728	Bagged	3/32 in	5/16 in	4-3/4 in	0.09 lb
82273	099575822735	Bagged	1/8 in	5/16 in	5 in	0.09 lb
82274	099575822742	Bagged	5/32 in	5/16 in	5-1/4 in	0.10 lb
82275	099575822759	Bagged	3/16 in	5/16 in	5-1/2 in	0.09 lb
82276	099575822766	Bagged	1/4 in	3/8 in	7 in	0.19 lb
82277	099575822773	Bagged	5/16 in	1/2 in	7 in	0.32 lb

GEARWRENCH® Long Taper Punches

- Used to Install and Remove Pins and Shafts and to Align Holes
- Meets or Exceeds ASME B107.47



Cat. No.	UPC No.	Packaging	Point Diameter	Stock Size	Overall Length	Product Weight
82278	099575822780	Bagged	1/8 in	3/8 in	8 in	0.21 lb
82279	099575822797	Bagged	5/32 in	1/2 in	8-1/2 in	0.36 lb
82280	099575822803	Bagged	3/16 in	1/2 in	9 in	0.38 lb
82281	099575822810	Bagged	1/4 in	5/8 in	11 in	0.79 lb

GEARWRENCH® Starter Punches

- Designed for Both Starting and Installing Pins and Rivets
- Meets or Exceeds ASME B107.47



Cat. No.	UPC No.	Packaging	Point Diameter	Stock Size	Overall Length	Product Weight
82282	099575822827	Bagged	5/32 in	3/8 in	5 in	0.14 lb
82283	099575822834	Bagged	3/16 in	3/8 in	5 in	0.14 lb
82284	099575822841	Bagged	1/4 in	1/2 in	6 in	0.29 lb
82285	099575822858	Bagged	1/8 in	5/16 in	4-1/2 in	0.09 lb
82286	099575822865	Bagged	5/16 in	5/8 in	7 in	0.54 lb
82287	099575822872	Bagged	3/8 in	3/4 in	8 in	0.86 lb

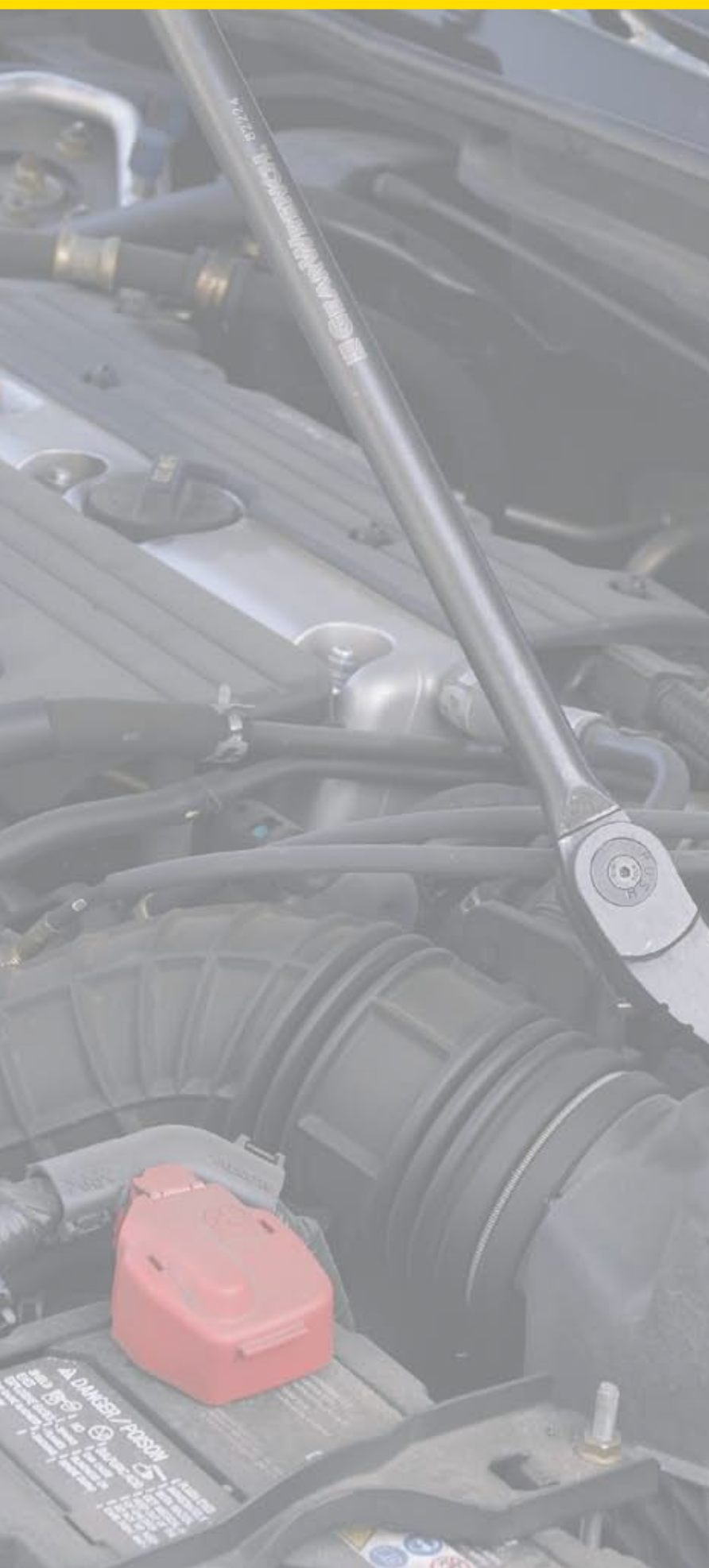

 **GEARWRENCH®**

Indexing Pry Bars 383

Extendable Pry Bars 384

Nail Pulling Pry Bar 384

GEARWRENCH® Pry Bars

The GearWrench® Indexing Pry Bar Program has changed the way prybars are used. The indexing head can get to where others can't and perform at 2x ANSI standards for safety and reliability. Offered in both standard and extendable handles, these prybars are a must for every box...and fit in the drawers too for easy secure storage.

INDEXING PRY BARS

Indexible to 180° for greater leverage

Puts the pry bar where you need it for best leverage

Exceeds ANSI requirements for proven strength



Extends from 29" to 48"

Push button to extend reach

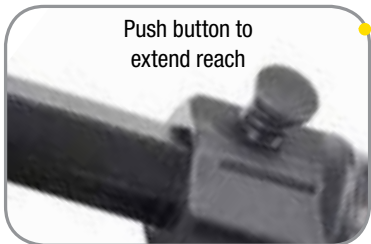

Extendable pry bar collapses so you can store it securely in your tool box



GEARWRENCH® 3 Pc. Pry Bar Set

- For Engine Repositioning and Placement, Aligning Steel Components and Fabrications and Repositioning Equipment
- Head Indexible Through 180° for Greater Leverage
- 8 in. and 10 in. Pry Bars Provide Leverage in Tight Confines
- 16 in. Pry Bar for Leverage in Medium-Duty Automotive and Industrial Applications
- 14 Locking Head Positions for Unmatched Access



Cat. No.	UPC No.	Packaging	Product Weight
82301D	099575823015	Boxed	4.33 lb

Cat. No.	Description	Cat. No.	Description
82208	8" Indexing Pry Bar	82216	16" Indexing Pry Bar
82210	10" Indexing Pry Bar		

GEARWRENCH® 2 Pc. Pry Bar Set

- For Engine Repositioning and Placement, Aligning Steel Components and Fabrications and Repositioning Equipment
- Head Indexible Through 180° for Greater Leverage
- 8 in. Pry Bar Provides Leverage in Tight Confines
- 16 in. Pry Bar for Leverage in Medium-Duty Automotive and Industrial Applications
- 14 Locking Head Positions for Unmatched Access



Cat. No.	UPC No.	Packaging	Product Weight
82300	099575823008	Boxed	2.43 lb

Cat. No.	Description	Cat. No.	Description
82208	8" Indexing Pry Bar	82216	16" Indexing Pry Bar

GEARWRENCH® Indexing Pry Bars

- For Leverage in Medium-Duty Automotive and Industrial Applications
- For Demolition, Repositioning Equipment, Aligning Steel Components, Engine Repositioning, and Other Heavy-Duty Applications
- 14 Locking Head Positions for Unmatched Access
- Grooved Profile Adds Traction on 24 in. and 33 in. Models



Cat. No.	UPC No.	Packaging	Length	Extendable Length	Product Weight
82208	099575822087	Boxed	8 in	No	0.87 lb
82210	099575822100	Boxed	10 in	No	1.08 lb
82216	099575822162	Boxed	16 in	No	1.69 lb
82224	099575822247	Boxed	24 in	No	5.10 lb
82233	099575822339	Boxed	33 in	No	5.90 lb

GEARWRENCH® Extendable Indexing Pry Bars

- For Demolition, Repositioning Equipment, Aligning Steel Components, Engine Repositioning, and Other Heavy-Duty Applications
- Extendable Handle Gives Greater Access and Leverage, and Collapses so it can be Stored Easily
- 14 Locking Head Positions for Unmatched Access
- Grooved Head Profile Provides Additional Traction
- Head Indexible through 180° for Greater Leverage



Cat. No.	UPC No.	Packaging	Cont. Length	Ext. Length	Extendable Length	Product Weight
82220	099575822209	Boxed	18.0 in	29.0 in	Yes	5.28 lb
82248	099575822483	Boxed	29.0 in	48.0 in	Yes	10.21 lb

GEARWRENCH® Nail Pulling Pry Bar

- Fits Nail Sizes 14D to 10D
- Indexible to 180 Degrees
- 14 Locking Positions



Cat. No.	UPC No.	Packaging	Length	Ext. Length	Product Weight
82212	099575822124	Boxed	12 in	12 in	4.82 lb

GEARWRENCH® 18 in. Rolling Wedge Bar



Cat. No.	UPC No.	Packaging	Product Weight
82200	099575822001	Boxed	1.58 lb



GEARWRENCH®

Service Kits	388
Engine Tools	396
Fuel Tools.....	401
Piston Service	413
Valve Tools.....	416
Exhaust	418
Battery.....	420
Electrical	422
Ignition	423
Spark Plug	425
Body Tools	428
Brake Service.....	436
Brake Bleeding	439
Brake Tubing	443
Brake Honers.....	446
Brake Measure	447
Wheel Tools	447
Oil Filter Wrenches	455
Steering.....	463
Suspension	464
Drive Train	468
Snap Rings.....	469
Feeler Gauges.....	472
Spark Plug Gap Gauges.....	473
Calipers.....	474
Automotive Inspection Tools.....	476
Pullers	478
General Purpose	481

GEARWRENCH® Auto Specialty

Since our beginning, Gearwrench® automotive specialty tools have been driven by innovation. From our first specialty tool, the Model-T valve spring lifter, to our latest Ratcheting Puller, we've built our reputation with tools that make tough jobs easy.

Most of our products have been upgraded with new improved features like dual material handles designed for a more comfortable grip or dual dipped handles on pliers providing more cushion for your hands.

Gearwrench® automotive specialty tools are proudly made with the finest components under the most stringent manufacturing guidelines. Made for everyday use – guaranteed for life.

Better tools mean easier, more efficient work so we constantly evaluate automotive engineering trends allowing us to consistently improve and enhance our tools to better fit professional hands. That's why they are the first choice for thousands of automotive technicians worldwide.

AUTOMOTIVE SERVICE KITS

Service kits, such as this disc/drum brake kit, contain all the tools required for a specific application. Most are available in a convenient and sturdy case.



15 Piece Brake Service Kit

SPECIALIZED APPLICATION TOOLS

GearWrench offers an ever growing variety of automotive specialized application tools designed to last and make the professionals job easier

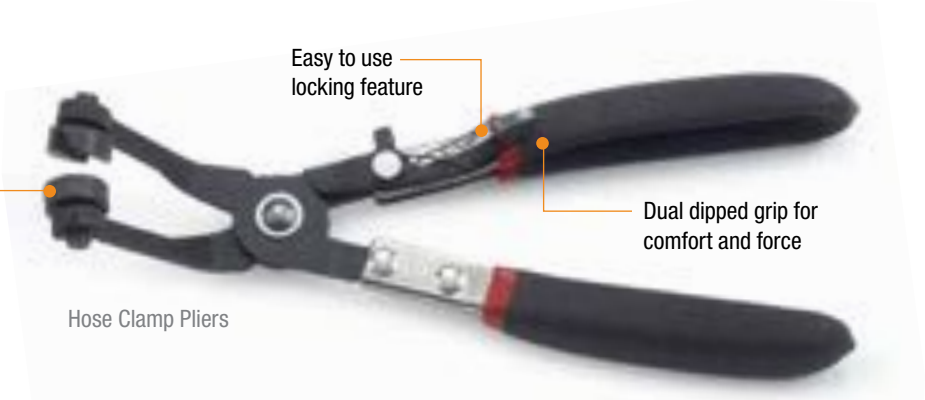

Hose Clamp Pliers

ENGINE TOOLS

Engine compartments have gotten tighter and GearWrench offers solutions to improve access and speed to service.



72 tooth ratcheting arm allows for greater access in tight engine compartments

15 Pc. Ratcheting Serpentine Belt Tool Set

Crowfoot Wrenches provide maximum coverage and access

GearWrench offers some of the most complete lines of Oil Filter Tools for almost all makes and models.

OIL FILTER WRENCHES



Stainless Steel Band

Dual material comfort grip handle

DIGITAL GAUGES

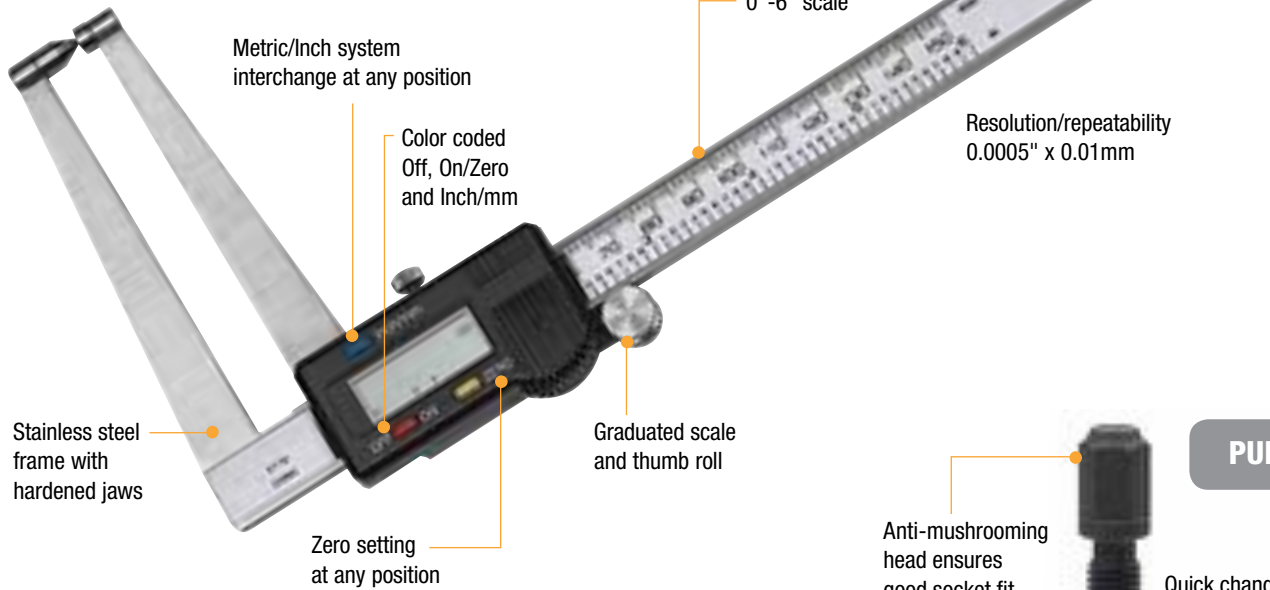

Metric/Inch system interchange at any position

Color coded Off, On/Zero and Inch/mm

0"-6" scale

Resolution/repeatability 0.0005" x 0.01mm

Stainless steel frame with hardened jaws

Graduated scale and thumb roll

Zero setting at any position

PULLERS



Anti-mushrooming head ensures good socket fit

Quick change jaws for 2- to 3-jaw, internal/external operations

Geared jaws for easy positioning

Forged jaws for strength

Chrome-plated rotating replaceable tip prevents surface marks

TESTING EQUIPMENT

GearWrench offers a wide range of automotive testing equipment such as this universal compression tester kit



GEARWRENCH® 12 Pc. Fuel & Trans Line Disconnect Set

■ Disconnect Tools that Separate Fittings on Fuel, Filter, Transmission, Air Conditioning Systems and Fuel Tank Return Lines on Most Vehicles, Trucks and Other Heavy Equipment



Cat. No.	UPC No.	Packaging	Description	Product Weight
41500	082171415005	Boxed	12 Pc. Fuel & Trans Line Disconnect Set	3.53 lb

Cat. No.	Description	Cat. No.	Description
3321	Fuel Line Quick Disconnect Tool	3894	Ford Auto Transmission to Radiator Line Disconnect Tool
3408D	Ford Fuel Line Coupling Tool	3895D	Disconnect for Fuel Lines Sizes 1/4" - Black
3413D	Ford Clutch Coupling Tool	3896D	Disconnect for Fuel Lines Sizes 5/16" - Red
3890D	Chrysler Quick Disconnect Tool	3897D	Disconnect for Fuel Lines Sizes 3/8" - Gold
3891D	GM Transmission Oil Cooler Line Disconnect Tool	3898D	Disconnect for Oil Cooler Line - Blue
3892D	GM Hydraulic Clutch Line Disconnect Tool	-	Replacement Bands
3893D	Transmission Oil Cooler Line Disconnect Tool		

GEARWRENCH® 15 Pc. Brake Service Set

- Kit Works on both Disc and Drum Brake Systems
- Use to Adjust Clearance Between Drum Brakes And Shoe, Remove and Install Shoe Return Springs and Brake Pads
- Heavy Duty Brake Spreader - Use with Both a 5/16" Socket Wrench or Use By Hand
- Brake Lining Thickness Gauge - Color Coded Brake Gauge Identifies Thickness Levels for Brake Lining Inspection



Cat. No.	UPC No.	Packaging	Description	Product Weight
41520	082171041525	Boxed	15 Pc. Brake Service Set	5.98 lb

Cat. No.	Description	Cat. No.	Description
287D	Drum Brake Adjusting Tool	80421	3/8" Drive Hex Bit Socket, 3/8"
298D	Brake Spring Pliers	80428D	3/8" Drive Hex Bit Socket, 7mm
2774D	Universal Brake Shoe Retaining Spring Tool	80429	3/8" Drive Hex Bit Socket, 8mm
3163D	Disc Brake Piston Tool	80431	3/8" Drive Hex Bit Socket, 10mm
3355D	GM-Ford Disc Brake Piston Tool	80451	3/8" Drive TORX® Press-Fit Bit Socket, T-40
3525D	Heavy Duty Brake Pad Separator	80452	3/8" Drive TORX® Press-Fit Bit Socket, T-45
3962	Brake Lining Thickness	80454	3/8" Drive TORX® Press-Fit Bit Socket, T-50
80419	3/8" Drive Hex Bit Socket, 1/4"		

GEARWRENCH® 11 Pc. Rear Brake Caliper Set

- Designed for Vehicles With Brake Pistons That are Mechanically Tied to the Parking Brake and Require a Turning Action to Push Back
- Set Covers Most Domestic and Import Vehicles



Cat. No.	UPC No.	Packaging	Description	Product Weight
41540	082171041549	Boxed	11 Pc. Rear Brake Caliper Set	5.14 lb

Cat. No.	Description	Cat. No.	Description
41541	Applicator & Pad for Brake Tool	41546D	Adapter 5: 1-3/8", 2 Pin, 3/8" Drive
41542	Adapter 0: 2-1/2", 1 Pin	41547	Adapter 6: 1-5/8", 2 Pin(L)
41543	Adapter 2: 2", 3 Pin	41548D	Adapter 7: 1-5/8", 2 Pin(S)
41544	Adapter 3: 2-1/4", 3 Step	41549D	Adapter 8: 1-7/8", 1 Pin
41545	Adapter 4: 1-1/4", 2 Pin	41550D	Adapter P: 2-1/4", 1 Pin

GEARWRENCH® Power Steering Pump Puller Set

- Removes and Installs Power Steering Pump Pulleys Off Most Domestic Vehicles



Cat. No.	UPC No.	Packaging	Product Weight
41560D	082171041563	Boxed	4.23 lb

Cat. No.	Description	Cat. No.	Description
3893D	Transmission Oil Cooler Line Disconnect Tool	41562D	Bushing and Screw Set B
41561D	Bushing and Screw Set A		

GEARWRENCH® Fan Clutch Service Set

- Covers Most Vehicles With Bolt on Pulleys and Also Newer Chrysler Engines With Press on Pulleys Requiring Special Pins to Hold Housing
- Features the Patented Universal Pulley Holder



Cat. No.	UPC No.	Packaging	Description	Product Weight
41580D	082171414572	Boxed	Fan Clutch Service Set	14.12 lb

Cat. No.	Description	Cat. No.	Description	Cat. No.	Description
3422	40mm Fan Nut Wrench	3901D	Pulley Holder Pin Set Small (8mm)	-	36mm Fan Nut Wrench
3473	Fan Clutch Wrench - Diesel	3902D	Pulley Holder Pin Set large (10mm, 18mm)	-	50mm Fan Nut Wrench
3900	Universal Pulley Holder	-	22mm Fan Nut Wrench		

GEARWRENCH® Master Bolt Grip Set

- Works on Harmonic Balancers, Steering Wheels, Crankshaft Pulleys, and Gears
- Capable of Handling Almost Every Two or Three-Way Bolt Pull Possible on Most Cars, Pickups, SUV's, and Small Engines



Cat. No.	UPC No.	Packaging	Product Weight
41600	082171041600	Boxed	7.16 lb

Cat. No.	Description	Cat. No.	Description
41601	3 Way Yoke for Bolt Grip Set	41604D	Bolt Sets (Zinc SAE)
41602	4 Pc. Puller Tip Set	41605	Center Screws for Puller
41603	Bolt Sets (Black Metric)		

GEARWRENCH® Front End Service Set

- Allows for Easy Removal of the Most Popular Types of Pitman Arms, Tie Rods, and Ball Joints



Cat. No.	UPC No.	Packaging	Description	Product Weight
41690	082171416903	Boxed	Front End Service Set	12.65 lb

Cat. No.	Description	Cat. No.	Description
2289D	Pitman Arm Puller	-	Tie Rod Puller
3916D	Universal Ball Joint Separator	-	Universal Tie Rod End Remover
3917D	Tie Rod End Puller and Pitman Arm Puller		

GEARWRENCH® Steering Service Set

- Can Remove a Steering Wheel From Most Domestic and Import Cars With or Without Telescoping Tilt Columns
- Use the Puller Legs With the Steering Wheel Puller to Remove Steering Wheels on Late Model GM Vehicles
- Steering Wheel Lock-Plate Depressor also Included



Cat. No.	UPC No.	Packaging	Description	Product Weight
41620D	082171416200	Boxed	Steering Service Set	4.36 lb

Cat. No.	Description	Cat. No.	Description
2291D	Crankshaft Pulley Puller (Steering Wheel Puller)	-	Lock Plate Depressor Frame
3509D	Steering Wheel Lock Plate Remover	-	Lock Plate Remover Collars & Nut Washer
3510D	Steering Wheel Puller Legs	-	Screw Package
3906D	Steering Wheel Pivot Pin		

GEARWRENCH® Bearing Race and Seal Set

- Install Tapered Bearing Races and Seals Without Damage to the Component or Housing
- Includes a Driver Handle Plus 9 Popular Bearing and Seal Drivers Ranging From 1.565" to 3.180"



Cat. No.	UPC No.	Packaging	Description	Product Weight
41630D	082171416309	Boxed	Bearing Race and Seal Set	4.74 lb

Cat. No.	Description	Cat. No.	Description
41631D	Driver Handle	41636D	2.470" Driver
41632	1.565" Driver	41637	2.555" Driver
41633	1.750" Driver	41638	2.830" Driver
41634	1.961" Driver	41639	2.995" Driver
41635	2.325" Driver	41640	3.180" Driver

GEARWRENCH® Axle Nut Set

- 7 Extra Long 1/2" Drive 6 Point Metric Sockets are Ideal for Heavy-Duty Use in Removing and Installing Axle Nuts Use With a Ratchet, Breaker Bar, Impact Wrench, or Torque Wrench



Cat. No.	UPC No.	Packaging	Description	Product Weight
41650	082171416507	Boxed	Axle Nut Set	12.39 lb

Cat. No.	Description	Cat. No.	Description
3907D	29mm Deep 1/2" Dr. Deep Axle Nut Socket, GM & Ford	3908D	35mm Deep 1/2" Dr. Deep Axle Nut Socket, GM
3161D	30mm Deep 1/2" Dr. Deep Axle Nut Socket, GM	3162D	36mm Deep 1/2" Dr. Deep Axle Nut Socket, GM
3270D	32mm Deep 1/2" Dr. Deep Axle Nut Socket, Honda/Chrysler	3909D	38mm Deep 1/2" Dr. Deep Axle Nut Socket, GM & Ford
3449D	34mm Deep 1/2" Dr. Deep Axle Nut Socket, GM		

GEARWRENCH® Spindle Nut Set

- 6 Chrome Vanadium Steel 1/2" Drive Sockets are for Most 4WD SUV's and Light Truck Axle Locknut Applications
- Use With a Torque Wrench, Ratchet, or Breaker Bar



Cat. No.	UPC No.	Packaging	Description	Product Weight
41660D	082171416606	Boxed	Spindle Nut Set	13.48 lb

Cat. No.	Description	Cat. No.	Description
2467	4-Lug 4WD Spindle Nut Socket, 1/2 to 3/4 Ton Dana 44	3910D	4WD Spindle Puller
2770D	6-Lug 4WD Spindle Nut Socket, 3/4 to 1 Ton Dana 44	3911D	Toyota Lock Nut Tool
3195D	4-Lug Socket with Extension 1/2 Ton Dana 80	3937	4-Lug 4WD Spindle Nut Socket 1/2 Ton Dana 50

GEARWRENCH® 10 Way Slide Hammer Puller Set

- Provides a Wide Range of Puller Applications Such as: Flange Type Axles, Oil Seals & Other Press Fit Parts
- Jaws Can Be Set Up for 2 or 3 Jaw Internal or External Pulling Jobs
- Includes Blow Mold Case for Storage



Cat. No.	UPC No.	Packaging	Product Weight
41700D	082171041709	Boxed	17.0 lb

Cat. No.	Description	Cat. No.	Description	Cat. No.	Description
3591D	5-1/2 lb. Slide Hammer Only	41706	Center Bolt & Cone	230071D	Shallow Flange
41704	2 Way Yoke	41707	3 Pc. Adapter Set	230075D	Deep Flange
41705	3 Way Yoke	41708	Leg Package & Screws		

GEARWRENCH® Rear Axle Bearing Puller Set

- Three Pullers Designed to Make the Removal of Semi-Floating Rear Axle Bearings Easier
- 1" X 1-7/8" Puller
- 1-5/16" X 2-3/8" Puller
- 1-3/8" X 2-7/8" Puller



Cat. No.	UPC No.	Packaging	Description	Product Weight
41710	082171417108	Boxed	Rear Axle Bearing Puller Set	3.3 lb

GEARWRENCH® 8 Pc. Sensor & Sending Socket Set

- Designed for the Removal and Installation of Oxygen Sensors, Oil Pressure Sending Units, and Vacuum Switches



Cat. No.	UPC No.	Packaging	Description	Product Weight
41720	082171417207	Boxed	8 Pc. Sensor & Sending Socket Set	5.68 lb

Cat. No.	Description	Cat. No.	Description
3919D	1/2" Drive 1-13/16" (29mm) Oil Sender Socket	3923D	3/8" Drive 1-1/16" Deep Oil Pressure Sending Socket
3920D	3/8" Drive 7/8" Slotted Socket for PVS, TVS, and O2 Socket	3924D	1/2" Drive 7/8" (22mm) Oxygen Sensor Socket
3921D	1/2" Drive 1-1/16" Thermal Sensor Socket	3925D	3/8" Drive 7/8" (22mm) Low Profile Offset Oxygen Sensor Socket
3922D	3/8" Drive 7/8" (22mm) Oxygen Sensor Socket		

GEARWRENCH® 3 Pc. Magnetic Spark Plug Set

- Contains Long Reach Magnetic Swivel Spark Plug Sockets
- Covers Sizes 5/8", 13/16", and 9/16"



Cat. No.	UPC No.	Packaging	Description	Product Weight
41730D	082171417306	Boxed	3 Pc. Magnetic Spark Plug Set	1.67 lb

Cat. No.	Description	Cat. No.	Description
3931D	9/16" Spark Plug Socket - Magnetic 2.5" Length	3930D	13/16" Swivel Spark Plug Socket - Magnetic 6" Length
3928D	5/8" Swivel Spark Socket - Magnetic 6" Length		

GEARWRENCH® 3 Pc. Magnetic Swivel Spark Plug Set

- Long Reach 5/8" Magnetic Swivel Spark Plug Socket Set
- Lengths of 4", 6", and 11"



Cat. No.	UPC No.	Packaging	Description	Product Weight
41740D	082171417405	Boxed	3 Pc. Magnetic Swivel Spark Plug Set	1.96 lb

Cat. No.	Description	Cat. No.	Description
3927D	5/8" Swivel Spark Plug Socket - Magnetic Plug 4" Length	3929D	5/8" Swivel Spark Plug Socket - Magnetic 11" Length
3928D	5/8" Swivel Spark Socket - Magnetic 6" Length		

GEARWRENCH® 8 Pc. SAE/Metric Stud Removal Set

- Complete SAE and Metric Stud Remover Set Offers the Best Professional Extractors Available
- Designed and Tested to Reach Studs in Difficult Work Areas



Cat. No.	UPC No.	Packaging	Description	Product Weight
41760D	082171417603	Boxed	8 Pc. SAE/Metric Stud Removal Set	2.55 lb

Cat. No.	Description	Cat. No.	Description
41761	6mm Removal Socket 3/8" Drive	41768D	1/4" Removal Socket 3/8" Drive
41762D	8mm Removal Socket 3/8" Drive	41767D	5/16" Removal Socket 3/8" Drive
41763D	10mm Removal Socket 1/2" Drive	41765	3/8" Removal Socket 1/2" Drive
41764	12mm Removal Socket 1/2" Drive	41766	7/16" Removal Socket 1/2" Drive

GEARWRENCH® General Purpose Bushing Set

- Perfect for Removing and Inserting Bushings in Cars, Trucks Buses, Tractors, Construction and Off-Road Equipment
- Set Includes Small, Medium, and Large Drivers and Bushing Adapters from 3/8" to 1-3/8"



Cat. No.	UPC No.	Packaging	Description	Product Weight
41780D	082171417801	Boxed	Gen Purp Bushing Set	4.04 lb

Cat. No.	Description	Cat. No.	Description	Cat. No.	Description
-	Bushing Adapter (1-1/16"- 1-3/16")	-	Bushing Adapter (11/16"-13/16")	-	Bushing Adapter (7/16"-1/2")
-	Bushing Adapter (1-3/16"- 1-5/16")	-	Bushing Adapter (13/16"-15/16")	-	Bushing Adapter (7/8"-1")
-	Bushing Adapter (1/2"-5/8")	-	Bushing Adapter (15/16"- 1-1/16")	-	Bushing Adapter (9/16"-11/16")
-	Bushing Adapter (1-1/4"- 1-3/8")	-	Bushing Adapter (15/32"-17/32")	-	Driver #1
-	Bushing Adapter (1-1/8"- 1-1/4")	-	Bushing Adapter (3/8"-7/16")	-	Driver #2
-	Bushing Adapter (1"-1-1/8")	-	Bushing Adapter (5/8"-11/16")	-	Driver #3
-	Bushing Adapter (3/4"-7/8")	-	Bushing Adapter (5/8"-3/4")	-	Driver Nut #1 and #2

GEARWRENCH® 9 Pc. Bushing Remover and Inserter Set

- Use to Remove and Insert Bushings Such As Those in Cars, Trucks, Buses, Tractors, Construction and Off-Road Equipment
- Sizes are Stamped on Each Bushing Adapter
- To Use, Select Proper Size Adapter and Drive Bushing Into Place
- Sizes Range from 1-5/16" to 1-3/4"



Cat. No.	UPC No.	Packaging	Description	Product Weight
31430	082171314308	Boxed	9 Pc. Bushing Remover and Inserter Set	4.90 lb

Cat. No.	Description	Cat. No.	Description	Cat. No.	Description
-	Bushing Adapter (1-1/2 to 1-5/8")	-	Bushing Adapter (1-5/16 to 1-7/16")	-	Bushing Adapter (1-9/32 to 1-3/4")
-	Bushing Adapter (1-11/32 to 1-1/2")	-	Bushing Adapter (1-7/16 to 1-9/16")	-	Driver #1
-	Bushing Adapter (1-3/4")	-	Bushing Adapter (1-9/16 to 1-11/16")	-	Driver Nut

GEARWRENCH® 6 Pc. Oil Canister Socket Set Service Kit

- Low Profile Sockets for Better Access



Cat. No.	UPC No.	Packaging	Description	Product Weight
41890	082171418907	Boxed	6 Pc. Oil Canister Socket Set Service Kit	2.08 lb

Cat. No.	Description	Cat. No.	Description	Cat. No.	Description
3935	24mm Oil Filter Socket	3936	29mm Oil Filter Socket	3934D	36mm Oil Filter Socket
3933D	27mm Oil Filter Socket	3932D	32mm Oil Filter Socket	3939D	38mm Oil Filter Socket

GEARWRENCH® 3 Pc. Oil Canister Socket Set

- Low Profile Sockets for Better Access



Cat. No.	UPC No.	Packaging	Description	Product Weight
41830	082171418303	Boxed	3 Pc. Oil Canister Socket Set	1.15 lb

Cat. No.	Description	Cat. No.	Description	Cat. No.	Description
3933D	27mm Oil Filter Socket	3932D	32mm Oil Filter Socket	3934D	36mm Oil Filter Socket

GEARWRENCH® Tubing Service Set

- For Tubing Service
- Broad Tubing Application Including Double Flare, Bend, Cut, Ream, and Deburr



Cat. No.	UPC No.	Packaging	Description	Product Weight
41590D	082171041594	Boxed	Tubing Service Set	3.70 lb

Cat. No.	Description	Cat. No.	Description	Cat. No.	Description
2107D	Mini Tubing Cutter	3905D	Deburring Tool	41595	Holding Bar
2189D	Tubing Bender	41594	7 Pc. Flaring Adapter Kit	41596	Yoke For Flaring Tool

GEARWRENCH® Double Flaring Tool Kit

- Complete Double Flaring Tool Assortment
- Slots on Yoke Firmly Engage with Bar Assembly
- Includes Corresponding Adapters for Forming Double Flares
- Forged Alloy Steel and Hardened
- Precisely Flares Tubing Up to 0.040" Wall Thickness to SAE 45° Flares
- Hardened Bar Assembly Clamps 7 Tubing Sizes: 3/16", 1/4", 5/16", 3/8", 7/16", 5/8", and 1/2"
- Do Not Use on Stainless Steel Tubing
- Additional Set Contents: SAE Bar Assembly, Yoke Assembly, Reamer, 3/16" Flaring Tool Adapter, 1/4" Flaring Tool Adapter, 5/16" Flaring Tool Adapter, 3/8" Flaring Tool Adapter, 7/16" Flaring Tool Adapter, 1/2" Flaring Tool Adapter, and 5/8" Flaring Tool Adapter



Cat. No.	UPC No.	Packaging	Description	Product Weight
41860	082171418600	Carded	Double Flaring Tool Kit (replaces 2199 & 3869)	4.05 lb

Cat. No.	Description	Cat. No.	Description
3905D	Deburring Tool	41595	Holding Bar
41594	7 Pc. Flaring Adapter Kit	41597	Universal Yoke

GEARWRENCH® Bubble Flaring Tool Kit

- Complete Bubble Flaring Tool Assortment
- Slots on Yoke Firmly Engage with Bar Assembly
- Includes Corresponding Adapters for Forming Double Flares
- Forged Alloy Steel and Hardened
- Precisely Flares Tubing Up to 0.040" Wall Thickness to Metric 45° Flares
- Hardened Bar Assembly Clamps 4 Tubing Sizes: 4.7, 6, 8, & 10mm
- Do Not Use on Stainless Steel Tubing
- Additional Set Contents: Metric Bar Assembly, Yoke Assembly, Reamer, 47mm Flaring Tool Adapter, 6mm Flaring Tool Adapter, 8mm Flaring Tool Adapter, and 10mm Flaring Tool Adapter



Cat. No.	UPC No.	Packaging	Description	Product Weight
41870	082171418709	Carded	Bubble Flaring Tool Kit (replaces 3482)	4.35 lb

Cat. No.	Description	Cat. No.	Description
3905D	Deburring Tool	41598D	Bubble Flaring Tool Holding Bar
41597	Universal Yoke	41599	4 Pc. Bubble Flaring Adapter Kit

GEARWRENCH® Combined Double / Bubble Flaring Tool Kit

- Complete Double and Bubble Flaring Tool Assortment
- Slots on Yoke Firmly Engage with Bar Assembly
- Includes Corresponding Adapters for Forming Double Flares
- Forged Alloy Steel and Hardened
- Precisely Flares Tubing Up to 0.040" Wall Thickness to SAE/ Metric 45° Flares
- Hardened Bar Assembly Clamps 11 Tubing Sizes: 3/16", 1/4", 5/16", 3/8", 7/16", 5/8", 1/2", 47, 6, 8, and 10mm
- Additional Set Contents: SAE Bar Assembly, Metric Bar Assembly, Yoke Assembly, Reamer, Cutter, 3/16" Flaring Tool Adapter, 1/4" Flaring Tool Adapter, 5/16" Flaring Tool Adapter, 3/8" Flaring Tool Adapter, 7/16" Flaring Tool Adapter, 1/2" Flaring Tool Adapter, 5/8" Flaring Tool Adapter, 4.7 mm Flaring Tool Adapter, 6mm Flaring Tool Adapter, 8mm Flaring Tool Adapter, 10mm Flaring Tool Adapter, and Cutter



Cat. No.	UPC No.	Packaging	Description	Product Weight
41880D	082171418808	Boxed	Combined Double / Bubble Flaring Tool Kit	7.35 lb

Cat. No.	Description	Cat. No.	Description	Cat. No.	Description
2107D	Mini Tubing Cutter	41592	Dual SAE and Metric Bar Assembly	41597	Universal Yoke
3905D	Deburring Tool	41593	10 Pc. Double Flaring Adapter Set	41599	4 Pc. Bubble Flaring Adapter Kit

GEARWRENCH® Radio Removal & Antenna Wrench Set

- Includes the Tools Needed to Remove the Radio From the Dash on Many Domestic and Import Vehicles Without Damage to the Radio or the Dash Panel
- Antenna Nut Sockets Fit Over Antennas and Down Into Deep Well Locations
- Set Includes: Radio Removal Tool, Key Set, Antenna Nut Socket Set



Cat. No.	UPC No.	Packaging	Description	Product Weight
41680D	082171416804	Boxed	Radio Removal & Antenna Wrench Set	2.06 lb

GEARWRENCH® Mechanic's Stethoscope

- Stethoscope Locates the Source of Engine Noise Quickly
- Listen for Trouble By Tracing the Sound of Flowing Water, Oil, Gas or Steam
- Identify Piston Slap, Worn Gears, Faulty Valves, Water Pump Failure, Damaged Gaskets and Defective Bearings
- Stethoscope Has a Shock-Resistant Handle and Disassembles for Storage



Cat. No.	UPC No.	Packaging	Description	Product Weight
835D	082171008351	Carded	Mechanic's Stethoscope	0.25 lb

GEARWRENCH® Small Hose Pinch-Off Pliers, 3/4" O.D. Capacity

- Ideal for Use on Radiator Hoses, Heater Hoses, Water, Air, Vacuum and Fuel Lines
- Capacity 3/4" Outside Diameter
- Extra Long Cushioned Hand Grips for Comfort and Control
- Clamping Mechanism Locks Automatically - No Screws Or Levers to Set Or Adjust
- Black Oxide Coated to Resist Rust and Corrosion



Cat. No.	UPC No.	Packaging	Length	Jaw Capacity	Product Weight
3791	082171037917	Carded	5-1/2 in	3/4 in	0.43 lb

GEARWRENCH® Medium Hose Pinch-Off Pliers, 1-1/4" O.D. Capacity

- Ideal for Use on Radiator Hoses, Heater Hoses, Water, Air, Vacuum and Fuel Lines
- Capacity 1-1/4" Outside Diameter
- Extra Long Cushioned Hand Grips for Comfort and Control
- Clamping Mechanism Locks Automatically - No Screws Or Levers to Set Or Adjust
- Black Oxide Coated to Resist Rust and Corrosion



Cat. No.	UPC No.	Packaging	Length	Jaw Capacity	Product Weight
3792D	082171037924	Carded	9-1/4 in	1-1/4 in	0.75 lb

GEARWRENCH® Large Hose Pinch-Off Pliers, 2-1/2" O.D. Capacity

- Ideal for Use on Radiator Hoses, Heater Hoses, Water, Air, Vacuum and Fuel Lines
- Capacity 2-1/2" Outside Diameter
- Extra Long Cushioned Hand Grips for Comfort and Control
- Clamping Mechanism Locks Automatically - No Screws Or Levers to Set Or Adjust
- Black Oxide Coated to Resist Rust and Corrosion



Cat. No.	UPC No.	Packaging	Length	Jaw Capacity	Product Weight
3793	082171037931	Carded	14 in	2-1/2 in	1.24 lb

GEARWRENCH® Hose Pinch Off Pliers

- Pliers Eliminate the Need to Drain Cooling System When Servicing
- Pliers Squeeze Hoses Shut and Jaws Swivel for Parallel Clamping
- Automatic Locking Ratchet
- Do Not Use on Wire-Reinforced Hose



Cat. No.	UPC No.	Packaging	Product Weight
145	082171001451	Carded	0.85 lb

GEARWRENCH® Corbin Style Hose Clamp Pliers

- For Corbin Style Hose Clamps
- Plier Tips Trap and Hold Clamp, and Swivel for Multiple Angle Access
- Easy to Use Locking Feature
- Dual Dipped for Additional Comfort



Cat. No.	UPC No.	Packaging	Product Weight
3975D	082171397509	Carded	0.74 lb

GEARWRENCH® Straight Hose Clamp Pliers

- For Use on Hose Clamps - Flat Band
- Easy to Use Locking Feature
- Dual Dipped for Additional Comfort



Cat. No.	UPC No.	Packaging	Product Weight
3976D	082171397608	Carded	0.75 lb

GEARWRENCH® Angled Hose Clamp Pliers

- For Use on Hose Clamps - Flat Band
- Angled Jaws Give Improved Access Around Obstructions
- Easy to Use Locking Feature
- Dual Dipped for Additional Comfort



Cat. No.	UPC No.	Packaging	Product Weight
3977	082171397707	Carded	0.84 lb

GEARWRENCH® Heavy-Duty Large Hose Clamp Pliers

- For Flat Ear Style Hose Clamps
- Plier Tips Trap and Hold Clamp, and Swivel for Multiple Angle Access
- Easy to Use Locking Feature
- Dual Dipped for Additional Comfort



Cat. No.	UPC No.	Packaging	Product Weight
3978D	082171397806	Carded	0.85 lb

GEARWRENCH® Remote Control Starter Switch

- Use to Bypass the Ignition Switch on Any Engine With a Solenoid Starter Switch
- Switch Lets You Crank the Engine While Working in the Engine Compartment
- Switch is Made of Heavy-Duty Construction and Has 32"-Long Leads
- To Use, Connect From the Positive Battery Terminal to the Energizing Terminal of Solenoid
- Use the Switch for GE Generator, Starter, Electrical, Fuel Pump and Compression Tests and for Setting Ignition Points and Adjusting Tappets
- 6 and 12 Volt Use Only
- Wire Rated Capacity 8 Amp
- Caution: Care Should Be Taken to Keep Away From Hot or Rotating Components



Cat. No.	UPC No.	Packaging	Description	Product Weight
124DD	082171001246	Carded	Remote Control Starter Switch	0.40 lb

GEARWRENCH® Oil-Seal Remover and Installer

- Tool Removes and Installs Upper Rear Main Oil Seals With Engine and Crank-Shaft in Place
- Works on Both Wick- and Neoprene-Type Seals
- Chinese Finger-Type Grip Won't Slip From the Seal During Installation
- Set Includes a Wick Seal Remover, Installer, Guide Funnels, Pusher, Offset Trimmer and Neoprene Seal Punches



Cat. No.	UPC No.	Packaging	Description	Product Weight
492	082171004926	Carded	Oil-Seal Remover and Installer	0.40 lb

GEARWRENCH® Flywheel Turner

- Hook This Tool Into Flywheel Teeth to Rotate the Crankshaft
- Use When Working on Clutches, Transmissions, Installing Rings or Other Jobs That Require the Crankshaft to Be in a Specific Position
- Spring Tension Aids Tool Engagement on the Flywheel



Cat. No.	UPC No.	Packaging	Description	Product Weight
2270	082171022708	Carded	Flywheel Turner	0.88 lb

GEARWRENCH® Compression Tester

- Tester Checks Cylinder Compression from 0 to 300 PSI (0 to 21 kg/cm2)
- Adapters fit 14 and 18mm Spark Plug Holes and Special Air-Hold Valve is included to Reset Gauge Easily
- Tester has a 16" Rubber Hose and is a Serviceable Product



Cat. No.	UPC No.	Packaging	Description	Product Weight
2428D	082171024283	Carded	Compression Tester	0.90 lb
242875	082171337642	Carded	Replacement Gauge	0.12 lb

GEARWRENCH® 4 Pc. Diesel Compression Test Kit

- Set Includes a Compression Gauge With Protective Boot and Special Air-Hold Valve for Easy Reset and Three Brass Adapters
- Brass Adapters are: 24mm X 20 to Test VW, Volvo, Audi, Dodge, Mercedes & Cummings 5.9-L; 10mm X 10 to Test GM 4.3-L 6 Cyl, 4.3-L & 5.7-L 8 Cyl, Ford/Navistar 6.9-L & 7.3-L, International Harvester 6.9-L; 10mm X 10 to Test GM 6.2-L V8
- Gauge Checks from 0 to 1000 PSI (0 to 70Kg/Cm2)
- Features a Quick Disconnect from Gauge to Adapters
- Kit Comes in a Blow Mold Case



Cat. No.	UPC No.	Packaging	Description	Product Weight
3468	082171034688	Carded	4 Pc. Diesel Compression Test Kit	1.45 lb

GEARWRENCH® Hand-Held Tachometer

- Tachometer Checks Diesels, Pumps, Compressors, Power Take-Offs and Farm and Construction Equipment Revolution Speed
- Tool is Ideal Where Electric Tachometer Cannot Be Used
- To Use, Hold Rubber Tip Against End of Rotating Shaft and Read Revolutions Per Minute Directly From Dial
- Range is 100 to 4000 RPM (Clockwise or Counterclockwise)
- Length: 4-1/4"
- Diameter: 2-3/4"



Cat. No.	UPC No.	Packaging	Description	Product Weight
2967	082171029677	Carded	Hand-Held Tachometer	0.75 lb

GEARWRENCH® 14 and 18mm Air Hold Extension Hose

- 14" Long Hose Incorporates Special 14 and 18mm Stepped Fitting With O-Ring Seals for Universal Fit and 1/4" NPT Fitting for Easy Connection to Air Lines
- Used With Valve Spring Compressors 912DD, 2078D and 3271DD
- Long Hose is Ideal for Reaching Deep Set Spark Plug Holes



Cat. No.	UPC No.	Packaging	Description	Product Weight
2992D	082171029929	Carded	14 and 18mm Air Hold Extension Hose	0.30 lb

GEARWRENCH® 2 Pc. Air Hold Fitting Set

- Use to Apply Air Pressure to keep Valve Closed while replacing Valve Spring
- Set Includes 14 and 18mm Adapters Threaded for 1/4" NPT
- To use, Remove Spark Plug and Screw Air Hold into Port
- Fasten Air Hose to Fitting and Apply Pressure
- Use with 912DD, 2078D or 3271DD Valve Spring Compressors
- Caution: Vehicle must be Placed in Park/Neutral before Applying Air Pressure, otherwise Vehicle may move
- Keep Hands Clear of Fan, Belts and Pulleys since Slight Crankshaft Rotation will Occur



Cat. No.	UPC No.	Description	Product Weight
901DD	082171009013	2 Pc. Air Hold Fitting Set	0.23 lb

GEARWRENCH® Oil Pressure Check Kit

- Test Engine Oil Pressure at the Oil Filter on Most Passenger Cars and Light Trucks
- Five Different Adapters are Included for Both Domestic and Imported Engines
- Gauge is Calibrated From 0 to 100 PSI



Cat. No.	UPC No.	Packaging	Description	Product Weight
3289	082171032899	Carded	Oil Pressure Check Kit	2.65 lb

GEARWRENCH® Engine/Automatic Transmission Oil Pressure Check Kit

- Use on All Domestic Cars and Light Trucks, As Well As Most Import Cars and Light Trucks
- Kit Includes: 2-1/2" Gauge Ranging From 0 to 300 PSI, 6" Neoprene (Oil-Proof) Hose, Brass Adapters for Sae and Metric and an Instruction Sheet



Cat. No.	UPC No.	Packaging	Description	Product Weight
3343D	082171033438	Carded	Engine/Automatic Trans. Oil Pressure Check Kit	1.25 lb

GEARWRENCH® 12 Point Serrated Wrenches

- Install and Remove 12-Point (Triple Square) Metric Socket-Head Screws by Turning with a Socket or Wrench
- Made From Heat-Treated Alloy Steel



Cat. No.	UPC No.	Packaging	Description	Product Weight
2304D	082171023040	Carded	8mm Serrated Wrench	0.08 lb
2305D	082171023057	Carded	10mm Serrated Wrench	0.18 lb
2306D	082171023064	Carded	12mm Serrated Wrench	0.22 lb

GEARWRENCH® 1-1/4" Scraper

- Stiff Tempered-Steel Blade is Ideal for Scraping Dirt, Carbon and Paint and for Applying Putty
- Blade is Ground to a Mirror Finish



Cat. No.	UPC No.	Packaging	Description	Product Weight
2425D	082171024252	Carded	1-1/4" Scraper	0.15 lb

GEARWRENCH® 3" Scraper

- Stiff Tempered-Steel Blade is Ideal for Scraping Dirt, Carbon and Paint and for Applying Putty
- Blade is Ground to a Mirror Finish



Cat. No.	UPC No.	Packaging	Description	Product Weight
2426D	082171024269	Carded	3" Scraper	0.24 lb

GEARWRENCH® Ramo-Matic Zerk Fitting Tool

- Tool Clears Grease Fittings of Hardened Matter
- Fits Straight and Angled Zerk-Type Fittings
- To Use, Fill With Oil or Grease, Hold Against Zerk Fitting and Strike With a Hammer to Clear Away Debris



Cat. No.	UPC No.	Packaging	Description	Product Weight
416D	082171004162	Carded	Ramo-Matic Zerk Fitting Tool	0.40 lb

GEARWRENCH® 2 Pc. Fuel Line Kit

- Set Includes Disconnect Tools for Use on Many Ford, GM and Mazda Vehicles
- Also Used on Chrysler and Ford A/C Line Adapters
- Tools Also Available Individually



Cat. No.	UPC No.	Packaging	Description	Product Weight
61059	082171610592	Carded	2 Pc. Fuel Line Kit	0.30 lb

Cat. No.	Description	Cat. No.	Description
3290D	Ford A/C and Fuel Line Spring Lock Coupling Tool	3321	Fuel Line Quick Disconnect Tool

GEARWRENCH® Ford A/C and Fuel Line Spring Lock Coupling Tool

- Most Ford Vehicles are Equipped With Spring Lock Couplings on Fuel and Air Conditioning Lines
- Necessary Tool Releases Locking Mechanism on All 4 Sizes: A (3/4"), B (5/8"), C (1/2") and D (3/8")



Cat. No.	UPC No.	Packaging	Description	Product Weight
3290D	082171032905	Carded	Ford A/C and Fuel Line Spring Lock Coupling Tool	0.20 lb

GEARWRENCH® Fuel Line Quick Disconnect Tool

- Tool Releases the Fuel Line Locking Mechanism on 1989 and Newer GM, 1990 and Newer Ford and Some 1990 and Newer Mazda Vehicles Fits 5/16" and 3/8" Fuel Lines



Cat. No.	UPC No.	Packaging	Description	Product Weight
3321	082171033216	Carded	Fuel Line Quick Disconnect Tool	0.15 lb

GEARWRENCH® 5 Pc. Low Profile Fuel Line Quick Disconnect Set

- Sizes Include: 7/8" (22mm), 3/4" (19mm), 5/8" (16mm) 3/8" (9mm) and 7/16" (8mm)
- Contains Five Popular Size Air Conditioning and Fuel Line Quick Disconnect Tools for Hard to Reach Areas
- Flexible Plastic Design Allows for Easy Application Over Tubing to Access Disconnects



Cat. No.	UPC No.	Packaging	Description	Product Weight
3530D	082171035302	Carded	5 Pc. Low Profile Fuel Line Quick Disconnect Set	0.60 lb

GEARWRENCH® Ford Fuel Line Coupling Tool

- Use on 1990 and Newer Ford Rangers and Explorers with 4.0-L, 6-Cylinder Engines
- Provides Easy, Damage-Free Fuel Line Separation, at the Fuel Pressure Regulators



Cat. No.	UPC No.	Packaging	Description	Product Weight
3408D	082171034084	Carded	Ford Fuel Line Coupling Tool	0.06 lb

GEARWRENCH® 12 Pc. Fuel & Trans Line Disconnect Set

■ Disconnect Tools that Separate Fittings on Fuel, Filter, Transmission, Air Conditioning Systems and Fuel Tank Return Lines on Most Vehicles, Trucks and Other Heavy Equipment



Cat. No.	UPC No.	Packaging	Description	Product Weight
41500	082171415005	Boxed	12 Pc. Fuel & Trans Line Disconnect Set	3.53 lb

Cat. No.	Description	Cat. No.	Description
3321	Fuel Line Quick Disconnect Tool	3894	Ford Auto Transmission to Radiator Line Disconnect Tool
3408D	Ford Fuel Line Coupling Tool	3895D	Disconnect for Fuel Lines Sizes 1/4" - Black
3413D	Ford Clutch Coupling Tool	3896D	Disconnect for Fuel Lines Sizes 5/16" - Red
3890D	Chrysler Quick Disconnect Tool	3897D	Disconnect for Fuel Lines Sizes 3/8" - Gold
3891D	GM Transmission Oil Cooler Line Disconnect Tool	3898D	Disconnect for Oil Cooler Line - Blue
3892D	GM Hydraulic Clutch Line Disconnect Tool	-	Replacement Bands
3893D	Transmission Oil Cooler Line Disconnect Tool		

GEARWRENCH® Chrysler Quick Line Disconnect Tool

Cat. No.	UPC No.	Packaging	Description	Product Weight
3890D	082171389009	Carded	Chrysler Quick Disconnect Tool	0.15 lb



GEARWRENCH® GM Transmission Oil Cooler Line Disconnect Tool

■ Works on Ford EFI Fuel Lines With Hair Pin Connectors; Works on Radiator to Transmission Oil Cooler Lines for 1987 - Current Cadillac Eldorado, Seville and Concours, Buick Riviera and Reatta, and Olds Toronado; 1989 - Current GM 1/2 Ton, 3/4 Ton, and 1-Ton Pick-Ups

Cat. No.	UPC No.	Packaging	Description	Product Weight
3891D	082171389108	Carded	GM Transmission Oil Cooler Line Disconnect Tool	0.15 lb



GEARWRENCH® GM Hydraulic Clutch Line Disconnect

■ Removes Clutch Lines From Slave Cylinders During Clutch Master Cylinder, Slave Cylinder or Clutch Assembly Service
 ■ Bent End Applications: Nvg3500 Manual Transmissions on 1966-Current Full-Size 2WD and 4WD Trucks

Cat. No.	UPC No.	Packaging	Description	Product Weight
3892D	082171389207	Carded	GM Hydraulic Clutch Line Disconnect Tool	0.15 lb



GEARWRENCH GM Transmission Oil Cooler Line Disconnect Tool

Works on Transmission Oil Cooler Lines On: 1987-Newer Olds Toronado, Buick Riviera and Reatta, Cadillac Eldorado, Seville and Concours; and 1989-Newer GM 1/2", 3/4", and 1-Ton Pickups

Cat. No.	UPC No.	Packaging	Description	Product Weight
3893D	082171389306	Carded	Transmission Oil Cooler Line Disconnect Tool	0.15 lb



GEARWRENCH Ford Auto Transmission to Radiator Line Disconnect Tool

Disconnects Transmission to Radiator Oil Cooler Line Quick Connect Fittings
AOD, ATX, or AXOD Transmissions

Cat. No.	UPC No.	Packaging	Description	Product Weight
3894	082171389405	Carded	Ford Auto Transmission to Radiator Line Disconnect Tool	0.15 lb



GEARWRENCH Disconnect for Fuel Lines Sizes 1/4" - Black

Cat. No.	UPC No.	Packaging	Description	Product Weight
3895D	082171389504	Carded	Disconnect for Fuel Lines Sizes 1/4" - Black	0.15 lb



GEARWRENCH Disconnect for Fuel Lines Sizes 5/16" - Red

Cat. No.	UPC No.	Packaging	Description	Product Weight
3896D	082171389603	Carded	Disconnect for Fuel Lines Sizes 5/16" - Red	0.15 lb



GEARWRENCH Disconnect for Fuel Lines Sizes 3/8" - Gold

Also Works on 3/8" Oil Cooler Lines

Cat. No.	UPC No.	Packaging	Description	Product Weight
3897D	082171389702	Carded	Disconnect for Fuel Lines Sizes 3/8" - Gold	0.15 lb



GEARWRENCH Disconnect for Oil Cooler Line - Blue

Cat. No.	UPC No.	Packaging	Description	Product Weight
3898D	082171389801	Carded	Disconnect for Oil Cooler Line - Blue	0.15 lb

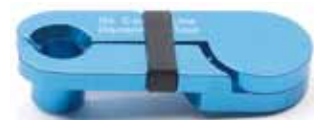

GEARWRENCH® Ford 7.3L Fuel Filter Tool

- Design Allows for Easy Removal and Installation of Ford 7.3L Diesel Fuel Caps and Other Diesel Filter Systems Using the Same Configuration
- Works With Fuel Caps From 1995 and Newer
- Improves Ability to Remove and Install Caps Where Access is a Problem
- Patented



Cat. No.	UPC No.	Packaging	Description	Product Weight
3526D	082171035265	Carded	Ford 7.3L Fuel Filter Tool	0.40 lb

GEARWRENCH® Fuel Pump Vacuum and Pressure Tester

- Test for Fuel Line Pressure and Vacuum Leaks and Check for Leaky Valves, Timing, Fuel Pump Vacuum and Pressure and Gas Line Leakage
- Tester is Equipped With an Easy-To-Read Gauge With a 3" Hose and a Vacuum Hose Adapter Fitting
- Gauge Measures Vacuum From 0 to 28" Hg in 1" Increments (0 to 700mm Hg in 50mm Increments)
- Also Measures Pressure From 0 to 15 PSI in 1/2 PSI Increments (0 to 1 Kg/Cm2 in 01 Kg/Cm2 Increments)
- Gauge Diameter 2-11/16"
- Caution: Not for Use on Fuel Injected Vehicles



Cat. No.	UPC No.	Packaging	Description	Product Weight
2521D	082171025211	Carded	Fuel Pump Vacuum and Pressure Tester	0.55 lb

GEARWRENCH® 8 Pc. Sensor & Sending Socket Set

- Designed for the Removal and Installation of Oxygen Sensors, Oil Pressure Sending Units, and Vacuum Switches



Cat. No.	UPC No.	Packaging	Description	Product Weight
41720	082171417207	Boxed	8 Pc. Sensor & Sending Socket Set	5.68 lb

Cat. No.	Description	Cat. No.	Description
3919D	1/2" Drive 1-13/16" (29mm) Oil Sender Socket	3923D	3/8" Drive 1-1/16" Deep Oil Pressure Sending Socket
3920D	3/8" Drive 7/8" Slotted Socket for PVS, TVS, and O2 Socket	3924D	1/2" Drive 7/8" (22mm) Oxygen Sensor Socket
3921D	1/2" Drive 1-1/16" Thermal Sensor Socket	3925D	3/8" Drive 7/8" (22mm) Low Profile Offset Oxygen Sensor Socket
3922D	3/8" Drive 7/8" (22mm) Oxygen Sensor Socket		

GEARWRENCH® 1-13/16 (29mm) 1/2" Drive Oil Sender Socket

- 1-3/16" (29mm) 1/2" Drive Oil Sender Socket
- Fits 1-3/16" Oil Pressure Sending Units Found on Late-80's and Mid-90's GM Vehicles
- (90mm Long)



Cat. No.	UPC No.	Packaging	Description	Product Weight
3919D	082171391903	Carded	1/2" Drive 1-13/16" (29mm) Oil Sender Socket	0.20 lb

GEARWRENCH® 7/8" Slotted Socket for PVS, TVS, and O2 Socket

- Removes and Installs Vacuum Switches with a 7/8" Hex
- Also Fits Some Oxygen Sensors (90mm Long)



Cat. No.	UPC No.	Packaging	Description	Product Weight
3920D	082171392009	Carded	3/8" Drive 7/8" Slotted Socket for PVS, TVS, and O2 Socket	0.20 lb

GEARWRENCH® 1/2" Drive 1-1/16" Thermal Sensor Socket

- Remove and Install 1973-1977 GM Thermal Sensor Switch
- Also Fits Some Oil Pressure Sending Units (85mm Long)



Cat. No.	UPC No.	Packaging	Description	Product Weight
3921D	082171392108	Carded	1/2" Drive 1-1/16" Thermal Sensor Socket	0.20 lb

GEARWRENCH® 7/8" (22mm) 3/8" Drive Oxygen Sensor Socket

- Removes and Installs Oxygen Sensors in Most Domestic and Some Imported Vehicles
- Slotted Socket Allows for Wire Clearance
- 80mm Long



Cat. No.	UPC No.	Packaging	Description	Product Weight
3922D	082171392207	Carded	3/8" Drive 7/8" (22mm) Oxygen Sensor Socket	0.20 lb

GEARWRENCH® 1-1/16" 3/8" Drive Deep Oil Pressure Sending Socket

- Deep Well Allows for Up to 2-5/8" Clearance (74mm Long)
- Works on Most 1991 and Newer GM Vehicles Using Oil Pressure Gauge: 4 Cylinder & 3.1 Liter V6
- 1987 and Newer Chrysler Vehicles With Light and Gauge Oil Pressure Switches



Cat. No.	UPC No.	Packaging	Description	Product Weight
3923D	082171392306	Carded	3/8" Drive 1-1/16" Deep Oil Pressure Sending Socket	0.20 lb

GEARWRENCH® 7/8" (22mm) Oxygen Sensor Socket

- Offset End Has Double Hex 1/2" Drive for Access (50mm Long)



Cat. No.	UPC No.	Packaging	Description	Product Weight
3924D	082171392405	Carded	1/2" Drive 7/8" (22mm) Oxygen Sensor Socket	0.20 lb

GEARWRENCH® 7/8" (22mm) Low Profile Offset Oxygen Sensor Socket

- Removes and Installs Oxygen Sensors in Most Domestic and Some Imported Vehicles
- 30mm Long

Cat. No.	UPC No.	Packaging	Description	Product Weight
3925D	082171392504	Carded	3/8" Drive 7/8" (22mm) Low Profile Offset Oxygen Sensor Socket	0.20 lb



GEARWRENCH® 1-1/16" 3/8" Drive Short Access Socket

- For Access to Some Chrysler Vehicles (54mm Long)

Cat. No.	UPC No.	Packaging	Description	Product Weight
3926D	082171392603	Carded	1-1/16 3/8"DR Short version socket	0.20 lb



GEARWRENCH® 15 Pc. Ratcheting Serpentine Belt Tool Set

- Patented Tool Combines the Innovation of a GearWrench® Ratcheting Wrench with the Requirements of the Serpentine Belt Removal Tool to Provide the Professional with the Best Possible Combination
- Includes Drive Tools: Long Bar, Special GearWrench® Ratcheting Wrench, and 3/8", 1/2" and 3/4" Adapters
- Includes 6 Point Sockets: 13mm, 14mm, 15mm, 16mm, 17mm, 18mm and 19mm
- Includes Crowsfoot: 13mm, 14mm and 15mm



Cat. No.	UPC No.	Packaging	Description	Product Weight
3680D	082171036804	Boxed	15 Pc. Ratcheting Serpentine Belt Tool Set	3.70 lb

GEARWRENCH® Serpentine Belt Tool

- Tool is Used to Release Tension on Serpentine Belt Self-Adjusting Idler Pulley
- Just Push or Pull to Release Tension
- Crow Foot Wrenches Provide Maximum Coverage and Access
- Includes Drive Tools: Long Bar and Short Bar
- Includes 12 Point Sockets: 13mm, 15mm, 16mm, 18mm and 19mm
- Includes Crowsfoot: 13mm, 14mm and 15mm



Cat. No.	UPC No.	Packaging	Description	Product Weight
3414D	082171034145	Carded	Serpentine Belt Tool	3.01 lb

GEARWRENCH® Serpentine Belt Stretch Tool

- Finger that Rocks Belt in Place instead of Twisting, Preventing Belt Damage
- Hardened Steel Pulley Pivot for Long Life
- Anodized Aluminum Body for Corrosion Resistance



Cat. No.	UPC No.	Packaging	Description	Product Weight
3681D	082171036811	Carded	Serpentine Belt Stretch Tool	0.12 lb

GEARWRENCH® Serpentine Belt Grabber Tool

- Ergonomic Spring-Loaded Handle Remotely Activates the Belt Grabber for Belt Routing
- Grabber Fingers Easily Control the Serpentine Belt During Installation / Removal
- Works Faster and Easier than Standard Belt Hook Tools
- Corrosion Resistant Steel to Promote Long Life



Cat. No.	UPC No.	Packaging	Description	Product Weight
3684D	082171036842	Carded	Serpentine Belt Grabber Tool	0.78 lb

GEARWRENCH® Fan Clutch Service Set

- Covers Most Vehicles With Bolt on Pulleys and Also Newer Chrysler Engines With Press on Pulleys Requiring Special Pins to Hold Housing
- Features the Patented Universal Pulley Holder



Cat. No.	UPC No.	Packaging	Description	Product Weight
41580D	082171414572	Boxed	Fan Clutch Service Set	14.12 lb

Cat. No.	Description	Cat. No.	Description	Cat. No.	Description
3422	40mm Fan Nut Wrench	3901D	Pulley Holder Pin Set Small (8mm)	-	36mm Fan Nut Wrench
3473	Fan Clutch Wrench - Diesel	3902D	Pulley Holder Pin Set large (10mm, 18mm)	-	50mm Fan Nut Wrench
3900	Universal Pulley Holder	-	22mm Fan Nut Wrench		

GEARWRENCH® Pulley Holder / Fan Clutch Tool Kit

- Universal Puller Holder Eliminates the Need for Various Size Holding Wrenches
- Used to Remove and Replace Thermostatic Fan Assemblies
- Applications Include: Ford Trucks W/2.8-L, 2.9-L, 3.0-L, 4.0-L, 4.9-L, and 5.0-L Engines; Dodge Trucks W/3.9-L, 5.2-L, 5.9-L, 8.0-L V10 Engines; GM Trucks W/4.3-L, 5.0-L and 5.7-L Engines



Cat. No.	UPC No.	Packaging	Description	Product Weight
3472	082171034725	Carded	Pulley Holder / Fan Clutch Tool Kit	5.10 lb

Cat. No.	Description	Cat. No.	Description
3422	40mm Fan Nut Wrench	3901D	Pulley Holder Pin Set Small (8mm)
3900	Universal Pulley Holder	-	36mm Fan Nut Wrench

GEARWRENCH® Universal Pulley Holder

- Unique Time Saving Tool is Designed to Trap and Hold Bolt-On Pulleys By the Mounting Bolts on Most Applications
- When Used in Conjunction With Fan Clutch Wrenches it is Especially Useful in Removing and Replacing Thermostatic Fan Assemblies while Eliminating the Need for Various Size Holding Wrenches
- Applications for Use in Fan Clutch Removal Include: Ford Trucks W/2.8-L, 2.9-L, 3.0-L, 4.0-L, 4.9-L, and 5.0-L Engines
- Dodge Trucks W/3.9-L, 5.2-L, 5.9-L, 8.0-L and V10 Engines
- GM Trucks W/4.3-L, 5.0-L and 5.7-L Engines
- Jeeps W/5.2-L Engines



Cat. No.	UPC No.	Packaging	Description	Product Weight
3900	082171390005	Carded	Universal Pulley Holder	1.50 lb

GEARWRENCH® Ford Fan Clutch Wrench, 4.9 L

- Wrench Removes Thermostatic Fan Assembly on 1993 and Newer 4.9-L Ford Engines
- Opening is 40mm (1.575")

Cat. No.	UPC No.	Packaging	Description	Product Weight
3422	082171034220	Carded	40mm Fan Nut Wrench	0.26 lb



GEARWRENCH® Fan Clutch Wrench - Diesel

- Use in Conjunction With the Universal Pulley Holder (3900) to Remove and Replace the Thermostatic Fan Assembly on Ford 6.9-L, 7.3-L, and 7.3-L Diesel Engines
- Use With 1/2" Drive Tools and a Torque Wrench
- Refer to Factory Service Manual for Torque Specifications and Thread Direction
- Wrench Opening is 48mm (1.889")

Cat. No.	UPC No.	Packaging	Description	Product Weight
3473	082171034732	Carded	Fan Clutch Wrench - Diesel	1.53 lb



GEARWRENCH® 2 Pc. Fan Clutch Pulley Holder Set - Ford Powerstroke 6.0 Liter

- Designed for Fan Clutch Removal on 2003 and Newer Ford 6.0-L Powerstroke Engines
- Unique Fan Clutch Wrench Grips and Securely Holds the Pulley Housing
- Fan Clutch Holding Tool to Loosen and Remove Oval or Round Hole Holding Nut

Cat. No.	UPC No.	Packaging	Description	Product Weight
3950	082171395055	Boxed	2 Pc. Fan Clutch Pulley Holder Set - Ford Powerstroke 6.0 Liter	11.24 lb



GEARWRENCH® Honda Acura Crankshaft Holding Tool

- Holds Crankshaft in Place Allowing for Removal of Hard-To-Loosen Crankshaft Damper Bolts
- Proper Angle Ensures Easy Access to Crankshaft Damper Bolts
- Fits Most Honda & Acura 4-Cylinder Applications From 1990 and Up
- Easy to Use One Man Operation Tool Speeds Up Repair
- Works With 1/2" Square Drive

Cat. No.	UPC No.	Packaging	Description	Product Weight
3970D	082171397004	Carded	Honda Acura Crankshaft Holding Tool	1.2950 lb



GEARWRENCH® Pulley Puller and Installer Set

- Remove Pressed-On Alternator and Power Steering Pulleys on GM, Ford, Chrysler Engines
- Threaded End Installs GM Alternator and Power Steering Pulleys, Including Quad 4
- Reverse the Jaws to Pull the Alternator Internal Bearing
- Will Not Work on 3.3-L and 3.5-L Chrysler Engines
- Includes Blow Mold Case

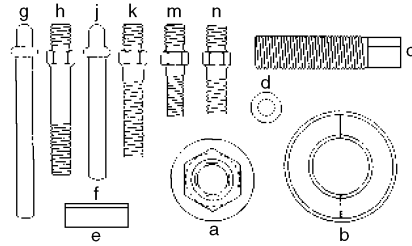

Cat. No.	UPC No.	Packaging	Description	Product Weight
2897D	082171028977	Carded	Pulley Puller and Installer Set	2.25 lb

Cat. No.	Description	Cat. No.	Description
289780	Replacement part: Puller Body (A)	289786	Replacement part: Screw Installer for Quad 4 (H)
289781	Replacement part: Jaw and Sleeve Assembly (B)	289787	Replacement part: Puller Pin for GM 3.1 (J)
289782	Replacement part: Jackscrew (C)	289788	Replacement part: Screw Installer for GM 3.1 (K)
289783	Replacement part: Button (D)	289789	Replacement part: Screw Installer for Ford 4.6 (M)
289784	Replacement part: Bearing (E) and Washer (F)	289790	Replacement part: Screw Installer for Others (N)
289785	Replacement part: Puller Pin for Quad 4 (G)		

GEARWRENCH® Power Steering Pump Puller Set

- Removes and Installs Power Steering Pump Pulleys Off Most Domestic Vehicles



Cat. No.	UPC No.	Packaging	Product Weight
41560D	082171041563	Boxed	4.23 lb

Cat. No.	Description	Cat. No.	Description
3893D	Transmission Oil Cooler Line Disconnect Tool	41562D	Bushing and Screw Set B
41561D	Bushing and Screw Set A		

GEARWRENCH® General Purpose Bushing Set

- Perfect for Removing and Inserting Bushings in Cars, Trucks Buses, Tractors, Construction and Off-Road Equipment
- Set Includes Small, Medium, and Large Drivers and Bushing Adapters from 3/8" to 1-3/8"



Cat. No.	UPC No.	Packaging	Description	Product Weight
41780D	082171417801	Boxed	Gen Purp Bushing Set	4.04 lb

Cat. No.	Description	Cat. No.	Description	Cat. No.	Description
-	Bushing Adapter (1-1/16"- 1-3/16")	-	Bushing Adapter (11/16"-13/16")	-	Bushing Adapter (7/16"-1/2")
-	Bushing Adapter (1-3/16"- 1-5/16")	-	Bushing Adapter (13/16"-15/16")	-	Bushing Adapter (7/8"-1")
-	Bushing Adapter (1/2"-5/8")	-	Bushing Adapter (15/16"- 1-1/16")	-	Bushing Adapter (9/16"-11/16")
-	Bushing Adapter (1-1/4"- 1-3/8")	-	Bushing Adapter (15/32"-17/32")	-	Driver #1
-	Bushing Adapter (1-1/8"- 1-1/4")	-	Bushing Adapter (3/8"-7/16")	-	Driver #2
-	Bushing Adapter (1"-1-1/8")	-	Bushing Adapter (5/8"-11/16")	-	Driver #3
-	Bushing Adapter (3/4"-7/8")	-	Bushing Adapter (5/8"-3/4")	-	Driver Nut #1 and #2

GEARWRENCH® 9 Pc. Bushing Remover and Inserter Set

- Use to Remove and Insert Bushings Such As Those in Cars, Trucks, Buses, Tractors, Construction and Off-Road Equipment
- Sizes are Stamped on Each Bushing Adapter
- To Use, Select Proper Size Adapter and Drive Bushing Into Place
- Sizes Range from 1-5/16" to 1-3/4"



Cat. No.	UPC No.	Packaging	Description	Product Weight
31430	082171314308	Boxed	9 Pc. Bushing Remover and Inserter Set	4.90 lb

Cat. No.	Description	Cat. No.	Description	Cat. No.	Description
-	Bushing Adapter (1-1/2 to 1-5/8")	-	Bushing Adapter (1-5/16 to 1-7/16")	-	Bushing Adapter (1-9/32 to 1-3/4")
-	Bushing Adapter (1-11/32 to 1-1/2")	-	Bushing Adapter (1-7/16 to 1-9/16")	-	Driver #1
-	Bushing Adapter (1-3/4")	-	Bushing Adapter (1-9/16 to 1-11/16")	-	Driver Nut

GEARWRENCH® Seal Puller

- Use Tool to Remove Oil and Grease Seals on Automobiles and Light Trucks
- Puller Has 2 Tip Sizes for Most Applications
- To Use, Insert Tip Behind Seal and Use Leverage to Remove
- Caution: Do Not Use As a Striking Tool
- For Intended Use Only



Cat. No.	UPC No.	Packaging	Description	Product Weight
3245	082171032455	Carded	Seal Puller	0.55 lb

GEARWRENCH® Master Bolt Grip Set

- Works on Harmonic Balancers, Steering Wheels, Crankshaft Pulleys, and Gears
- Capable of Handling Almost Every Two or Three-Way Bolt Pull Possible on Most Cars, Pickups, SUV's, and Small Engines



Cat. No.	UPC No.	Packaging	Product Weight
41600	082171041600	Boxed	7.16 lb

Cat. No.	Description	Cat. No.	Description
41601	3 Way Yoke for Bolt Grip Set	41604D	Bolt Sets (Zinc SAE)
41602	4 Pc. Puller Tip Set	41605	Center Screws for Puller
41603	Bolt Sets (Black Metric)		

GEARWRENCH® Harmonic Balancer Installer

- Installs Drive Pulleys on Harmonic Balancers
- Complete Range of Adapters
- Comes With Thrust Bearing for Ease of Use



Cat. No.	UPC No.	Packaging	Description	Product Weight
36790D	082171367908	Boxed	Harmonic Balancer Installer	3.34 lb

Cat. No.	Description	Cat. No.	Description	Cat. No.	Description
367971	Adapter 14mm x 1.5	367976	Adapter 7/16 x 20	367982	10mm X 1.5 Adapter for 36790 Kit
367972	Adapter 16mm x 2.0	367977	Adapter 9/16 x 18	367983	12mm X 1.75 Adapter for 36790 Kit
367973	Adapter 1/2 x 20	367978	Adapter 12mm x 1.5	367984	14mm X 2.0 Adapter for 36790 Kit
367974	Adapter 3/4 x 16	367980	Center Screw	367985	16mm X 1.5 Adapter for 36790 Kit
367975	Adapter 5/8 x 18	367981	Bushing and Washer Kit		

GEARWRENCH® Harmonic Balancer Puller

- Puller Removes Balancers, Pulleys, and Gears with Tapped Holes
- Floating Swivel Prevents Damage to the Shaft End
- Four Slots in the Yoke Allow for 2- or 3-Hole Applications
- Tool Bolts to Balancer with Center Screw on the End of the Crankshaft
- Tighten while Tapping on the Screw Head to Remove Balancer
- Puller includes 3/8-24 UNF, 5/16-18 UNC, 3/8-16 UNC and 10mm x 1.5 Screws for most American and Imported Cars



Cat. No.	UPC No.	Packaging	Description	Product Weight
2286D	082171022869	Carded	Harmonic Balancer Puller	2.25 lb
228675	082171337420	Bagged	Replacement Part: Yoke and Screw Swivel	1.35 lb
228677	082171337444	Bagged	Replacement Part: Screw Assortment	1.00 lb

GEARWRENCH® Piston Ring Compressor Set

- Set Includes Pliers and 6 Bands, 1119 Through 1124
- Install Pistons From 2-7/8 to 4-3/8" (73 to 111mm)
- Pliers Can Be Used Parallel or Perpendicular to the Cylinder Block
- Fine-Tooth Ratcheting Lock Allows You to Compress Bands in Small Increments
- Set Works By Placing a Band Around the Piston, Covering the Rings and Hooking Pliers Into the Band and Squeezing
- With the Band Tightly Around the Piston, Insert Piston Into Cylinder and Tap Lightly With Hammer Handle to Install



Cat. No.	UPC No.	Packaging	Description	Product Weight
850DD	082171008504	Boxed	Piston Ring Compressor Set	2.18 lb

Cat. No.	Description	Cat. No.	Description
1119D	Piston Ring Compressor Band (2-7/8" to 3-1/8")	1123D	Piston Ring Compressor Band (3-7/8" to 4-1/8")
1120D	Piston Ring Compressor Band (3-1/8" to 3-3/8")	1124D	Piston Ring Compressor Band (4-1/8" to 4-3/8")
1121D	Piston Ring Compressor Band (3-3/8" to 3-5/8")	1125D	Piston Ring Compressor Band (4-3/8" to 4-5/8")
1122D	Piston Ring Compressor Band (3-5/8" to 3-7/8")		

GEARWRENCH® Piston Ring Compressor Pliers

- Use these Pliers to Install Pistons from 2-5/8 to 5-7/8" (67 to 149mm) in Diameter
- Self-Locking Ratchet Allows you to Compress Rings in Small Increments
- Pliers can be used Parallel or Perpendicular to the Cylinder Block on Most Bands



Cat. No.	UPC No.	Packaging	Product Weight
1114D	082171011146	Carded	0.80 lb

GEARWRENCH® Piston Ring Compressor Bands

- Use These Bands With 1114 Pliers to Compress Piston Rings From 2-7/8 to 4-5/8" in Diameter
- Band Width: 1-1/2"



Cat. No.	UPC No.	Packaging	Description	Product Weight
1119D	082171011191	Bagged	Piston Ring Compressor Band (2-7/8" to 3-1/8")	0.20 lb
1120D	082171011207	Bagged	Piston Ring Compressor Band (3-1/8" to 3-3/8")	0.22 lb
1121D	082171011214	Bagged	Piston Ring Compressor Band (3-3/8" to 3-5/8")	0.24 lb
1122D	082171011221	Bagged	Piston Ring Compressor Band (3-5/8" to 3-7/8")	0.24 lb
1123D	082171011238	Bagged	Piston Ring Compressor Band (3-7/8" to 4-1/8")	0.26 lb
1124D	082171011245	Bagged	Piston Ring Compressor Band (4-1/8" to 4-3/8")	0.26 lb
1125D	082171011252	Bagged	Piston Ring Compressor Band (4-3/8" to 4-5/8")	0.32 lb

GEARWRENCH® Piston Ring Compressor

- Use Compressor to Install Pistons 3-1/2 to 6-1/2" (89 to 164mm) in Diameter
- Positive Lock Action Provides Positive Compression and Fingertip Release
- Heavy Spring Steel Compresses the Stiffest Rings Evenly
- Tool is Beaded Along Lower Edge to Prevent Compressor From Entering the Cylinder



Cat. No.	UPC No.	Packaging	Description	Product Weight
1723D	082171017230	Carded	Piston Ring Compressor, 3-1/2" to 6-1/2" (89 to 164mm); Trucks and Tractors	0.80 lb

GEARWRENCH® Diesel Ring Compressor

- Use to Install Pistons 3-1/2 to 7" (89 to 177mm) in Diameter on Trucks and Tractors
- This 6-1/2" High Positive Lock Compressor Has 4 Tension Bands and Compresses Diesel Upper and Lower Rings
- Bands are Made of Spring Steel and Beaded Along Lower Edge to Prevent Compressor From Entering the Cylinder

Cat. No.	UPC No.	Packaging	Description	Product Weight
1724	082171017247	Carded	Diesel Ring Compressor	1.60 lb



GEARWRENCH® Heavy Duty Piston Ring Compressor

- Use Compressor to Install Pistons 2-1/8 to 5" (54 to 127mm) in Diameter
- Positive Lock Action Provides Positive Compression and Fingertip Release
- to Compress Piston Ring Into Grooves, Slip the Tool Over the Piston and Tighten With L-Shaped Wrench
- Insert Piston Into Cylinder and Tap With a Hammer to Install
- Enlarged Crimped Edge Prevents Compressor From Entering the Cylinder

Cat. No.	UPC No.	Packaging	Description	Product Weight
2284D	082171022845	Carded	Heavy Duty Piston Ring Compressor, 2-1/8 to 5" (54 to 127mm)	0.65 lb



GEARWRENCH® Piston Ring Groove Cleaner

- Effectively Removes Carbon From Ring Grooves on Pistons 2 to 5" (51 to 127mm)
- Two 5-Bladed Cutters Cover All Major Piston Ring Grooves in SAE and Metric Sizes
- Cutters Rotate to any Selected Size, Locking in Place with Hold-Down Nut
- Included Cutter #1: 1/16", 5/64", 3/32", 1/8", 3/16"
- Included Cutter #2: 1.5mm, 2.5mm, 3mm, 4mm, 5mm

Cat. No.	UPC No.	Packaging	Description	Product Weight
1722D	082171017223	Carded	Piston Ring Groove Cleaner	0.18 lb
172271	082171337055	Carded	Replacement Cutter Blade Kit	0.08 lb



GEARWRENCH® Engine Cylinder Ridge Reamer

- Reamer Removes Ridges from Top of Engine Cylinders with Bore Diameters 3 to 5" (77 to 127mm)
- Tungsten Carbide Cutters and Fine-Thread Feed-Up Ensure Smooth Cutting Action
- Unique Design lets you Change from One Cylinder to Another without Readjusting

Cat. No.	UPC No.	Packaging	Description	Product Weight
2389D	082171023897	Carded	Engine Cylinder Ridge Reamer	2.90 lb
238978	082171337574	Carded	Replacement Cutter Blade	0.08 lb



GEARWRENCH® Engine Cylinder Hone

- Hone and Remove Glaze From Engine Cylinders From 2" to 7" (51 to 177mm) in Diameter
- Adjust Spring Tension for Positive Cutting Action and Set Diameter With Spread Limiter
- Hone Includes Medium Grit Stones - Grit No 240

Cat. No.	UPC No.	Packaging	Description	Product Weight
2833D	082171028335	Carded	Engine Cylinder Hone	0.90 lb



GEARWRENCH® 4" Replacement Stones

Stones are for 2833D Engine Cylinder Hone



Cat. No.	UPC No.	Packaging	Description	Product Weight
2834D	082171028342	Carded	4" Replacement Stones (Coarse Grit) - No. 100	0.30 lb
2835D	082171028359	Carded	4" Replacement Stones (Medium Grit) - No. 240	0.25 lb
2836DD	082171028366	Carded	4" Replacement Stones (Fine Grit) - No. 400	0.25 lb

GEARWRENCH® 3" Replacement Stones (Medium Grit)



Cat. No.	UPC No.	Packaging	Description
3157	082171031571	Carded	3" Replacement Stones (Medium Grit) - No. 240

GEARWRENCH® Engine Cylinder Flex-Hones

- Hone Engine Cylinders 3-1/4 to 4-1/8" (83 to 105mm) in Diameter to Produce a Plateaued Finish for Fast Ring Seating and Better Oil Retention for Longer Engine Life
- Hone Life is in Excess of 1000 Cylinders
- Requires No Setup
- Use Variable-Speed 3/8" Electric Hand Drill and Move the Flex-Hone® Up and Down in the Cylinder Until Desired Results are Obtained



Cat. No.	UPC No.	Packaging	Description	Product Weight
2486	082171024863	Carded	Engine Cylinder Flex-Hones (3-1/2", 89mm); Min Working Diameter (3-1/4", 83mm); 120 Grit	0.75 lb
2487D	082171024870	Carded	Engine Cylinder Flex-Hones (3-3/4", 95mm); Min Working Diameter (3-1/2", 89mm); 120 Grit	0.75 lb
2488D	082171024887	Carded	Engine Cylinder Flex-Hones (4-1/8", 105mm); Min Working Diameter (3-3/4", 95mm); 120 Grit	0.90 lb

GEARWRENCH® Heavy Duty Engine Cylinder Flex-Hones

- Heavy-Duty Hone Engine Cylinders, 2-3/4 to 4-1/2" (70 to 114mm) in Diameter, Deliver the Same Plateaued Finish as the Standard-Duty, but are Longer Lasting



Cat. No.	UPC No.	Packaging	Description	Product Weight
2489D	082171024894	Carded	Heavy Duty Engine Cylinder Flex-Hones (3", 76mm); Min Working Diameter (2-3/4", 70mm); 120 Grit	0.75 lb
2490D	082171024900	Carded	Heavy Duty Engine Cylinder Flex-Hones (3-1/4", 82mm); Min Working Diameter (3", 76mm); 120 Grit	1 lb
2491	082171024917	Carded	Heavy Duty Engine Cylinder Flex-Hones (3-1/2", 89mm); Min Working Diameter (3-1/4", 83mm); 120 Grit	0.90 lb
2492	082171024924	Carded	Heavy Duty Engine Cylinder Flex-Hones (4", 101mm); Min Working Diameter (3-1/2", 89mm); 120 Grit	1.25 lb
2493DD	082171024931	Carded	Heavy Duty Engine Cylinder Flex-Hones (4-1/2", 114mm); Min Working Diameter (4", 101mm); 120 Grit	1.30 lb

GEARWRENCH® Valve Grinder

- Hand Grind Small and Large Flat-Head Unslotted Valves
- Textured Handle and Thin Wall Suction Cups Make Grinding Easy
- To Use, Place Grinding Compound on Valve Face and Put in Seat
- Put Suction Cup on Valve Head and Turn Handle Between Hands to Grind
- There are 2 Sizes Per Tool



Cat. No.	UPC No.	Packaging	Description	Product Weight
501D	082171005015	Carded	Small Valve Grinder (5/8", 13/16" Diameter)	0.10 lb
505D	082171005053	Carded	Standard Valve Grinder (1-1/8", 1-3/8" Diameter)	0.15 lb

GEARWRENCH® Valve Spring Compressor

- Compress Valve Springs on Overhead Valve and L-head Engines on Cars, Trucks and Tractors
- Tool has a 9-3/4" Throat Depth and Jaw Openings 2-3/4 to 7-3/4" fits larger engine sizes
- Jaws and Plunger Bar are easily Adjusted
- Plunger Bar Seats on Both Flat- and Cup-Shaped Valve Heads
- Offset and Straight Jaws are Included



Cat. No.	UPC No.	Packaging	Description	Product Weight
380	082171003806	Boxed	Valve Spring Compressor	7.80 lb

GEARWRENCH® Small Engine Valve Spring Compressor

- Long and Slender, Will Reach Into Small Recesses Where Valve Springs and Retaining Washers are Located
- Arms are Hinged at One End So They are Practically Parallel at the Other End at All Points
- Jaws are Adjustable in Width and Have Edges So Thin That They Can Be Forced Under and Over Ends of Valve Spring to Compress It for Removal
- Operating Screw Makes Ratchets and Locks Unnecessary
- Will Work on All Briggs and Stratton Engines
- Maximum Opening 2-3/8"



Cat. No.	UPC No.	Packaging	Description	Product Weight
379D	082171003790	Carded	Small Engine Valve Spring Compressor	1.40 lb

GEARWRENCH® Valve Spring Compressor

- Remove and Replace Valve Springs in GM 8-cylinder Engines
- Heavy-duty Tool Replaces Weak or Broken Valve Springs and Guide Seals with Cylinder Head on the Engine
- Compressor is Used by Removing Rocker and Fastening Tool to Stud with Nut
- Pull on the Handle to Compress Spring
- Use with 901DD or 2992D Air Hold Fittings to Keep Valve Closed
- Length: 12-1/2"
- Caution: Vehicle must be Placed in Park/Neutral before Applying Air Pressure, otherwise Vehicle may move. Keep hands clear of Fan, Belts and Pulleys since slight Crankshaft Rotation will Occur



Cat. No.	UPC No.	Packaging	Description	Product Weight
912DD	082171009129	Carded	Valve Spring Compressor	1.16 lb

GEARWRENCH® Valve Spring Compressor

- Compressor Services Overhead Valve Engines
- Handle on the Outside of the Tool Makes it Easy to Use. It has a Throat Depth of 7-1/2" and Jaw Openings 2-3/4 to 5-7/8"
- Compressor fits most Passenger Cars and Light Trucks and will also work on Small L-head Engines with Manifolds Removed
- 38370D Offset Jaws are Included

Cat. No.	UPC No.	Packaging	Description	Product Weight
383D	082171003837	Carded	Valve Spring Compressor	4.65 lb
38370D	082171383700	Bagged	Replacement Part: Jaw Set (Newer Style)	0.53 lb



GEARWRENCH® Valve Spring Compressor

- Compress Valves on Small Overhead Valve or L-head Engines
- Tool has a Throat Depth of 6-1/4" and Jaw Openings of 3 to 5-3/8"
- Designed for Light-weight Valve Springs
- Compressor Works on L-heads with Manifolds Removed and many Industrial Engines

Cat. No.	UPC No.	Packaging	Description	Product Weight
385D	082171003851	Carded	Valve Spring Compressor	2.55 lb
38570D	082171385704	Bagged	Replacement Part: Jaw Set (New Style)	0.65 lb



GEARWRENCH® Deluxe Universal Overhead Valve Spring Compressor

- Compressor Easily Removes Valve Springs on Most Cars and Light Trucks
- Tool Can Be Used With the Cylinder Head on or Off the Engine
- Features a Removable Handle Allowing Use With 5/8" Socket or Wrench in Confined Areas and an Extra-Long Leg for More Applications
- For Best Results, Use With 901DD or 2992D Air Hold Fittings to Pressurize the Cylinder and Keep the Valves in Place During Removal of the Spring and Keepers
- Caution: Vehicle Must Be Placed in Park/Neutral Before Applying Air Pressure, Otherwise Vehicle May Move
- Keep Hands Clear of Fan, Belts and Pulleys Since Slight Crankshaft Rotation Will Occur

Cat. No.	UPC No.	Packaging	Description	Product Weight
3271DD	082171032714	Carded	Deluxe Universal Overhead Valve Spring Compressor	0.95 lb
327175D	082171318344	Bagged	Replacement Long Leg, Length 3-15/32"	0.28 lb
327176	082171318351	Bagged	Replacement Short Leg, Length 3-5/32"	0.25 lb



GEARWRENCH® Universal Overhead Valve Spring Compressor

- Remove Valve Springs on Most Cars With Overhead Valves Without Removing the Cylinder Head
- Offset Jaws Grip the Valve Spring in Parallel Compression
- Tool Maintains Constant Length As Spring is Compressed
- Use With 901DD or 2992D Air Hold Fittings to Keep Valve in Place
- Caution: Vehicle Must Be Placed in Park/Neutral Before Applying Air Pressure, Otherwise Vehicle May Move
- Keep Hands Clear of Fan, Belts and Pulleys Since Slight Crankshaft Rotation Will Occur

Cat. No.	UPC No.	Packaging	Description	Product Weight
2078D	082171020780	Carded	Universal Overhead Valve Spring Compressor	0.95 lb



GEARWRENCH® Exhaust and Tailpipe Cutter

- Cut Pipes 3/4" to 3" (19 to 76mm) in Diameter
- Fifteen Blades Effectively Cut Pipe so only 1/4 Turn is needed for a Complete Cut
- Patented, Serviceable Tool Works in Hard-to-Reach Areas
- Will not cut Double-Wall Pipes
- Keep Well Oiled
- Not for use on Stainless Steel



Cat. No.	UPC No.	Packaging	Description	Product Weight
2031DD	082171020315	Carded	Exhaust and Tailpipe Cutter	1.16 lb
203182D	082171231766	Boxed	Replacement Cutting Chain	0.32 lb

GEARWRENCH® Exhaust and Tailpipe Expander (1-13/16" to 2-1/2")

- Flare, Shape and Expand Tailpipes to Ensure a Tight Fit and Prevent Exhaust Leaks
- Turn Handle to Adjust the Expander to the Diameter of the Pipe
- Pipe Size 1-1/2" to 2-1/2" (38mm to 63.5mm)



Cat. No.	UPC No.	Packaging	Description	Product Weight
2071D	082171020711	Carded	Exhaust and Tailpipe Expander (1-13/16" to 2-1/2")	2.65 lb

GEARWRENCH® 4 Pc. Scraper Set

- Includes 4 Flat Scrapers
- Innovative Dual Material handle for Comfort and Performance
- Oil and Solvent Resistant



Cat. No.	UPC No.	Packaging	Description	Product Weight
84080	099575840807	Carded	Scraper Set	2.11 lb

Cat. No.	Description	Cat. No.	Description
84081	1/4" Wide Scraper	84083	1" Wide Scraper Long
84082	1/2" Wide Scraper	84084	1" Wide Scraper Short

GEARWRENCH® 2 Pc. Scraper Set

- Innovative Dual Material handle for Comfort and Performance
- Oil and Solvent Resistant



Cat. No.	UPC No.	Packaging	Description	Product Weight
84070	099575840708	Carded	Scraper Set	1.15 lb

Cat. No.	Description	Cat. No.	Description
84071	1" Wide Reverse Scraper	84072	1" Wide Offset Scraper

GEARWRENCH® 1" Knot-type Wire-End Brush

- Brush Removes Rust, Carbon and Paint From Metal and Other Surfaces
- Designed for Heavy-Duty Use and Consists of Industrial Tempered Straight Twisted Wire 0.020"
- Use with Electric Drills, Pneumatic Tools or Flexible Shaft Equipment
- Face Diameter: 1"
- Shank Diameter: 1/4"
- Maximum Safe Free Speed: 20,000 RPM



Cat. No.	UPC No.	Packaging	Product Weight
2312DD	082171023125	Carded	0.45 lb

GEARWRENCH® 2-1/2" Wire Cup Brush

- Brush Removes Light Scale, Rust and Paint From Surfaces
- Designed for Light-Duty Use With 0.014" High Carbon Steel Wire
- Use in Electric Drills or Flexible Shaft Equipment



Cat. No.	UPC No.	Packaging	Product Weight
2314D	082171023149	Carded	0.86 lb

GEARWRENCH® Curved Handle Wire Scratch Brush

- Clean Carbon, Dirt and Paint from Metal and other Surfaces with this Wooden-Handle Brush
- Overall Length: Approximately 14"
- Bristle Area: 3 X 19 Rows, 1-1/8" Trim and 6" Long



Cat. No.	UPC No.	Packaging	Product Weight
2310D	082171023101	Carded	0.35 lb

GEARWRENCH® Shoe Handle Wire Scratch Brush

- Use This Hardwood-Handle Brush to Clean Dirt, Carbon and Rust From Metal and Other Surfaces
- Bristles are Densely Packed Over 5-1/4"
- Overall Length: Approximately 10"
- Bristle Area: 4 X 16 Rows and 1-1/8" Trim



Cat. No.	UPC No.	Packaging	Product Weight
2311D	082171023118	Carded	0.35 lb

GEARWRENCH® Parts Cleaning Brush

- Brush Removes Grease and Dirt From Automotive Parts
- Strong Handle with Durable Polypropylene Bristles will Hold Up Under Repeated use in Cleaning Solvents



Cat. No.	UPC No.	Packaging	Product Weight
242	082171002427	Carded	0.20 lb

GEARWRENCH® Stainless Steel Brush

- Brush Has Hand-Tied Stainless Steel Tufts for Cleaning Corrosion from Parts without Scratching
- Brush Size: 3/8" X 1-3/8"
- Handle Length: 7"



Cat. No.	UPC No.	Packaging	Product Weight
2309D	082171023095	Carded	0.05 lb

GEARWRENCH® 5/16" Side Terminal Battery Wrench



Cat. No.	UPC No.	Packaging	Description	Product Weight
3367	082171033674	Carded	Side Terminal Battery Wrench	0.33 lb

GEARWRENCH® Battery Terminal Puller

- Use Puller to Remove the Battery Terminal Clamp Without Damaging the Battery Post
- Puller Will Even Work on Corroded Spring-Type Clamps
- To Use, Loosen the Clamp Bolt, Place Jaws Under Each Side of the Battery Cable Clamp and Tighten the Center Screw Until the Clamp is Free



Cat. No.	UPC No.	Packaging	Description	Product Weight
202D	082171002021	Carded	Battery Terminal Puller	0.50 lb

GEARWRENCH® Battery Terminal Spreader and Cleaner

- Clean and Spread Battery Cable Terminals With This Plier-Type Tool
- Sharp Teeth Effectively Clean Corrosion From the Clamp
- Squeeze the Handle to Spread the Clamp



Cat. No.	UPC No.	Packaging	Description	Product Weight
204D	082171002045	Carded	Battery Terminal Spreader and Cleaner	0.60 lb

GEARWRENCH® Battery Nut Pliers

- Loosen and Tighten Nuts on Battery Terminal Clamps
- Offset Handles for Working in Cramped Areas
- Serrated Jaws Provide Firm Grip



Cat. No.	UPC No.	Packaging	Product Weight
203D	082171002038	Carded	0.45 lb

GEARWRENCH® Three-Way Battery Tool

- Sharp Steel Blades on This Tool Remove Corrosion and Put a Correct Angle on Terminal Clamps and Posts
- Use the 6-Blade, Tapered Reamer to Quickly Clean Terminal Clamps
- Post Cleaners are Marked Positive and Negative, and are Sized to Accurately Fit Terminal Posts and Cut the Correct Angle
- Proper Cleaning of Terminals and Posts Ensures Perfect Contact



Cat. No.	UPC No.	Packaging	Description	Product Weight
2173DD	082171021732	Carded	Three-Way Battery Tool	0.15 lb

GEARWRENCH® Metal Battery Brush

- Durable Metal Brush to Remove Corrosion and Dirt from Battery Terminals and Cable Clamps
- Rugged Metal Case has a Long Life



Cat. No.	UPC No.	Packaging	Description	Product Weight
206D	082171002069	Carded	Battery Brush	0.25 lb

GEARWRENCH® Plastic Battery Brush

- Removes Corrosion and Dirt from Battery Terminals and Cable Clamps
- High-impact, Plastic Case will not Corrode or Soften Brush in Cleaning Solutions



Cat. No.	UPC No.	Packaging	Description	Product Weight
201D	082171002014	Carded	Battery Brush	0.16 lb

GEARWRENCH® Battery Carrying Strap, Top Mount

- Carry Top-Terminal Batteries with this Strong, Plastic Strap
- Ends are Marked and Sized to Accurately Fit Positive and Negative Terminals
- Not Harmed by Battery Acid
- Length: 14"



Cat. No.	UPC No.	Packaging	Description	Product Weight
205D	082171002052	Carded	Battery Carrying Strap	0.25 lb

GEARWRENCH® Low-Voltage Circuit Tester

- Test for Voltage in 6 and 12V Systems by Grounding the Clip and Touching the Probe to the Point being Tested
- Tester Bulb will Light if Power is Present
- Replacement Bulb Part: 12675 (GE 1449 Bulb)



Cat. No.	UPC No.	Packaging	Description	Product Weight
129D	082171001291	Carded	Low-Voltage Circuit Tester	0.43 lb

GEARWRENCH® High-Low Voltage Tester

- Test for Voltage in 6 and 12V Systems for Voltage and Spark Plugs for Spark by Grounding the Clip and Touching the Probe to the Point being Tested
- Tester Bulb will Light if Power is Present
- To Use as a Spark Tester, Screw the Probe to the Opposite End of the Handle



Cat. No.	UPC No.	Packaging	Description	Product Weight
126D	082171001260	Carded	High-Low Voltage Tester	0.20 lb
12678	082171126789	Bagged	Replacement Part: Neon Bulb	0.01 lb
12675	082171126758	Bagged	Replacement part: GE 1449 Bulb	0.01 lb

GEARWRENCH® Low-Voltage Circuit Tester

- Circuit Tester for 6 and 12V Electrical Systems is Ideal for the Home Mechanic
- Quickly Checks Headlight, Taillight and Turn Signal Circuits, Faulty Sockets, Connections, Fuses and Broken Wires
- Comes in a Tough, Durable Shock-Resistant Case
- Includes 12V Bulb and 36" Cable
- Replacement Bulb: 1893



Cat. No.	UPC No.	Packaging	Description	Product Weight
2646D	082171026461	Carded	Low-Voltage Circuit Tester	0.15 lb

GEARWRENCH® Circuit Continuity Tester

- Includes 36" Cable. One Aar Battery Required (Not Included). Uses Bulb #112 Screw-In Design
- Designed for the Home Mechanic, This Tool Safely Tests Circuits With Power Off
- Ideal for Testing Fuses, Grounds, Shorts, Contacts, Diodes and Open Circuits



Cat. No.	UPC No.	Packaging	Description	Product Weight
2647D	082171026478	Carded	Circuit Continuity Tester	1.12 lb

GEARWRENCH® Circuit and Spark Plug Tester

- Includes 36" Cable. Uses Bulb #1893
- Checks 6 and 12V Circuits for Voltage and Checks Spark Plug for Spark
- Place Probe in End With Regular Bulb to Check Low Voltage
- Checks Headlights, Taillights, Turn Signals and Other Circuits
- Tests for Faulty Sockets, Connections and Broken Wires
- Place Probe in End With Neon Bulb to Check for Spark Voltage
- Tester Comes in a Shock-Proof Case



Cat. No.	UPC No.	Packaging	Description	Product Weight
2649D	082171026492	Carded	Circuit and Spark Plug Tester	0.15 lb

GEARWRENCH® HEI Ignition Tester

- Accurately Check for Spark in Ignition Systems Without Removing Spark Plug From Engine
- Testers Verify That Energy is Sufficient for Spark Plug to Fire
- Attach Spark Plug Wire to Tester End
- Clamp Tester to Engine As Ground
- Crank Engine and Check for Spark



Cat. No.	UPC No.	Packaging	Description	Product Weight
2756D	082171027567	Carded	HEI Ignition Tester	0.15 lb

GEARWRENCH® Standard Ignition Tester

- Accurately Check for Spark in Ignition Systems Without Removing Spark Plug From Engine
- Testers Verify That Energy is Sufficient for Spark Plug to Fire
- Attach Spark Plug Wire to Tester End
- Clamp Tester to Engine As Ground
- Crank Engine and Check for Spark



Cat. No.	UPC No.	Packaging	Description	Product Weight
2757D	082171027574	Carded	Standard Ignition Tester	0.15 lb

GEARWRENCH® Short Circuit Detector

- Locates Short Circuits in 6 and 12V Systems Right Through Upholstery, Body Panels and Metal Door Posts
- Connect Tester Across Burned Out Fuse
- Move Meter Along Wire Routing
- Meter Needle Will Oscillate Until Short is Found



Cat. No.	UPC No.	Packaging	Description	Product Weight
2524D	082171025242	Carded	Short Circuit Detector	0.35 lb

GEARWRENCH® Current Indicator

- Measures Alternator and Starter Dc Current in 6, 12 and 24V Systems
- Indicates Direction of Current Flow Without Breaking Into Lines
- Starter Current Scale: 600-0-600
- Alternator Current Scale: 75-0-75
- Place Meter on Wire
- Crank Engine to Check Starter Current
- Run Engine to Check Alternator Current



Cat. No.	UPC No.	Packaging	Description	Product Weight
2423D	082171024238	Carded	Current Indicator	0.10 lb

GEARWRENCH® Distributor Clamp Wrench

- Reaches around obstructions to turn distributor lock
- Fits 1/2" and 9/16" lock nuts
- Use adapter to join wrenches or attache wrench to a 3/8" ratchet or extension



Cat. No.	UPC No.	Packaging	Description	Product Weight
104	082171001048	Carded	Distributor Clamp Wrench	0.60 lb
10473	082171104732	Bagged	Replacement Part: Coupler for Distributor Clamp Wrench	0.05 lb

GEARWRENCH® Ignition File

- Use Tool to File Ignition Points and Other Small Objects
- The Thin Blade Has a Fine Grid on Both Sides and is Ideal for Removing Carbon From Points



Cat. No.	UPC No.	Packaging	Description	Product Weight
2153D	082171021534	Carded	Ignition File	0.03 lb

GEARWRENCH® Electrical Wire Stripper and Crimper

- All-Purpose Tool Includes Pliers Type Nose, Crimper, Wire Cutter, Stripper and Bolt Cutter
- Crimper Works on Insulated and Non-insulated Terminals. Non-insulated Auto 7 & 8mm, and Electrical 22-20 to 22-10. Insulated Electrical 22-20 to 12-10.
- Bolt Cutters for Bolt Sizes 4-40, 5-40, 6-32, 8-32, 10-32 and 10-24

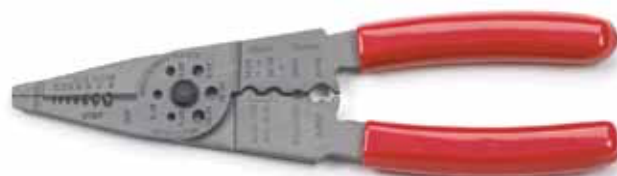

Cat. No.	UPC No.	Packaging	Description	Product Weight
2162D	082171021626	Carded	Electrical Wire Stripper and Crimper	0.50 lb

GEARWRENCH® Spark Plug Terminal Pliers

- Safely Remove Spark Plug Cables and Prevent Cable Damage



Cat. No.	UPC No.	Packaging	Product Weight
135D	082171001352	Carded	0.53 lb

GEARWRENCH® 14mm and 18mm Spark Plug Open Thread Chaser

- Clean and Restore Spark Plug Threads with a 13/16" Socket
- Rubber Ring Eliminates Slipping
- Tool Services Most Cars



Cat. No.	UPC No.	Packaging	Description	Product Weight
730D	082171007309	Carded	14mm and 18mm Spark Plug Open Thread Chaser	0.30 lb

GEARWRENCH® 14mm Cylinder Head Rethreader Kit

- Repair Damaged 14mm Spark Plug Threads By Opening Hole With a Reamer/Tap and Screwing Insert Onto the Spark Plug
- Use Spark Plug Socket to Install Spark Plug and Insert
- Remove Plug and Check That Insert is Properly Seated
- Set Includes 1 Each of 4 Inserts: 3/8, 7/16, 1/2 and 3/4" Reach and Thread Locking Compound
- Tap is Designed for Aluminum Heads Only



Cat. No.	UPC No.	Packaging	Description	Product Weight
2125D	082171021251	Carded	14mm Cylinder Head Rethreader Kit	0.30 lb

GEARWRENCH® 14mm Spark Plug Thread Inserts

- Use to Replace Damaged 14mm Spark Plug Threads on Aluminum Head Engines Only
- Use With 2123D Reamer/Tap to Repair Holes
- Thread Locking Compound and 1 Pair of Inserts are Included
- Inserts are Designed for Use in Holes Reworked With Reamer/Tap Listed



Cat. No.	UPC No.	Packaging	Description	Product Weight
2126D	082171021268	Carded	3/8" Spark Plug Thread Inserts	0.05 lb
2127D	082171021275	Carded	7/16" Spark Plug Thread Inserts	0.05 lb
2128D	082171021282	Carded	1/2" Spark Plug Thread Inserts	0.05 lb
2129DD	082171021299	Carded	3/4" Spark Plug Thread Inserts	0.05 lb

GEARWRENCH® 14mm Spark Plug Rethreader

- Tool Features Extra-Long Neck for Access to Recessed Spark Plug Cavities
- Groove and O-Ring Holds Tool in Socket
- Use With 3/8" Square Drive Tool or a 5/8" Socket



Cat. No.	UPC No.	Packaging	Description	Product Weight
3379D	082171033797	Carded	14mm Spark Plug Rethreader	0.10 lb

GEARWRENCH® 14mm Spark Plug Insert Reamer/Tap

- Opens Damaged Spark Plug Hole Threads Prior to Using Spark Plug Thread Inserts
- Use Inserts 2126D Through 2129DD to Repair 14mm Spark Plug Holes on Aluminum Heads Only



Cat. No.	UPC No.	Packaging	Description	Product Weight
2123D	082171021237	Carded	14mm Spark Plug Insert Reamer/Tap	0.20 lb

GEARWRENCH® 3 Pc. Magnetic Spark Plug Set

- Contains Long Reach Magnetic Swivel Spark Plug Sockets
- Covers Sizes 5/8", 13/16", and 9/16"



Cat. No.	UPC No.	Packaging	Description	Product Weight
41730D	082171417306	Boxed	3 Pc. Magnetic Spark Plug Set	1.67 lb
Cat. No.	Description	Cat. No.	Description	
3931D	9/16" Spark Plug Socket - Magnetic 2.5" Length	3930D	13/16" Swivel Spark Plug Socket - Magnetic 6" Length	
3928D	5/8" Swivel Spark Socket - Magnetic 6" Length			

GEARWRENCH® 3 Pc. Magnetic Swivel Spark Plug Set

- Long Reach 5/8" Magnetic Swivel Spark Plug Socket Set
- Lengths of 4", 6", and 11"



Cat. No.	UPC No.	Packaging	Description	Product Weight
41740D	082171417405	Boxed	3 Pc. Magnetic Swivel Spark Plug Set	1.96 lb
Cat. No.	Description	Cat. No.	Description	
3927D	5/8" Swivel Spark Plug Socket - Magnetic Plug 4" Length	3929D	5/8" Swivel Spark Plug Socket - Magnetic 11" Length	
3928D	5/8" Swivel Spark Socket - Magnetic 6" Length			

GEARWRENCH® Magnetic Swivel Spark Plug Sockets

- Magnetic Swivel Design for Easy Installation or Removal of Spark Plugs



Cat. No.	UPC No.	Packaging	Fastener Size	Overall Length	Product Weight
3931D	082171393105	Carded	9/16 in	2-1/2 in	0.10 lb
3938D	082171039386	Carded	9/16 in	6 in	0.30 lb
3927D	082171392702	Carded	5/8 in	4 in	0.20 lb
3928D	082171392801	Carded	5/8 in	6 in	0.30 lb
3929D	082171392900	Carded	5/8 in	11 in	0.44 lb
3930D	082171393006	Carded	13/16 in	6 in	0.30 lb

GEARWRENCH® 7 Pc. Hook & Pick Set



Cat. No.	UPC No.	Packaging	Description	Product Weight
84000D	099575840005	Blow Mold Tray	7 Pc. Hook & Pick Set	1.56 lb
Cat. No.	Description	Cat. No.	Description	
84001D	5" Cotter Pin Puller	84005	3-1/8" 90° Mini Hook	
84002D	4" Hose Pick Puller	84006	3-1/8" Straight Mini Hook	
84003D	4-1/2" Awl	84007	3-1/8" Mini Offset Hook	
84004D	3-1/8" Mini Full Hook			

GEARWRENCH® 4 Pc. Mini Hook & Pick Set



Cat. No.	UPC No.	Packaging	Description	Product Weight
84040	099575840401	Retail Packaging	4 Pc. Mini Hook & Pick Set	0.44 lb
Cat. No.	Description	Cat. No.	Description	
84004D	3-1/8" Mini Full Hook	84006	3-1/8" Straight Mini Hook	
84005	3-1/8" 90° Mini Hook	84007	3-1/8" Mini Offset Hook	

GEARWRENCH® 4" Hose Pick Puller

- Good for hose removal, spring clamps, or other prying
- Overall Length: 8"



Cat. No.	UPC No.	Packaging	Description	Product Weight
84002D	099575840029	Carded	4" Hose Pick Puller	0.22 lb

GEARWRENCH® 4-1/2" Awl

- Use as scratch awl or hole punch
- Overall Length: 9.5"



Cat. No.	UPC No.	Packaging	Description	Product Weight
84003D	099575840036	Carded	4-1/2" Awl	0.20 lb

GEARWRENCH® 5" Cotter Pin Puller

- Good for seal pick and other general cleaning projects, including cotter pins
- Overall Length: 9.5"



Cat. No.	UPC No.	Packaging	Description	Product Weight
84001D	099575840012	Carded	5" Cotter Pin Puller	0.26 lb

GEARWRENCH® 3-1/8" Mini Full Hook

- Good for hooking springs and other objects
- Small size for tight access areas
- Overall Length: 6.5"



Cat. No.	UPC No.	Packaging	Description	Product Weight
84004D	099575840043	Carded	3-1/8" Mini Full Hook	0.16 lb

GEARWRENCH® 3-1/8" 90° Mini Hook

- Use for seal pick removal
- Overall Length: 6.5"



Cat. No.	UPC No.	Packaging	Description	Product Weight
84005	099575840050	Carded	3-1/8" 90° Mini Hook	0.07 lb

GEARWRENCH® 3-1/8" Straight Mini Hook

- Good to use as hole punch or and mini scratch awl
- Overall Length: 6.5"



Cat. No.	UPC No.	Packaging	Description	Product Weight
84006	099575840067	Carded	3-1/8" Straight Mini Hook	0.07 lb

GEARWRENCH® 3-1/8" Mini Offset Hook

- Use for seals and delicate cleaning applications
- Overall Length: 6.5"



Cat. No.	UPC No.	Packaging	Description	Product Weight
84007	099575840074	Carded	3-1/8" Mini Offset Hook	0.16 lb

GEARWRENCH® 4 Pc. Door Panel Remover Set



Cat. No.	UPC No.	Packaging	Description	Product Weight
84060	099575840609	Carded	Set includes tools to help remove door panels with minimal damage	2.34 lb

Cat. No.	Description	Cat. No.	Description
84061	20" Door Panel Remover	84064	Door Panel Remover - V
84063	Door Panel Remover - Square	84065	Trim Pad Tool

GEARWRENCH® 20" Door Panel Remover



Cat. No.	UPC No.	Description	Product Weight
84061	099575840616	20" Door Panel Remover	0.73 lb

GEARWRENCH® 10" Door Panel Remover U Shape



Cat. No.	UPC No.	Packaging	Description	Product Weight
84062	099575840623	Carded	10" Door Panel Remover - U	0.42 lb

GEARWRENCH® Door Panel Remover - Square



Cat. No.	UPC No.	Description	Product Weight
84063	099575840630	Door Panel Remover - Square	0.85 lb

GEARWRENCH® Door Panel Remover - V



Cat. No.	UPC No.	Description	Product Weight
84064	099575840647	Door Panel Remover - V	0.45 lb

GEARWRENCH® Trim Pad Tool



Cat. No.	UPC No.	Description	Product Weight
84065	099575840654	Trim Pad Tool	0.50 lb

GEARWRENCH® 3 Pc. Body Clip Set

- 30° and 80° Offset Push Pin Pliers
- Panel Clip Pliers with "V" Design for Removal of Standard Clips without Center Pins



Cat. No.	UPC No.	Packaging	Description	Product Weight
41850	082171418501	Carded	3pc Body Clip Set	1 lb

Cat. No.	Description	Cat. No.	Description
3705	Panel Clip Pliers	3888D	Push Pin Pliers - 80°
3729	Push Pin Removal Pliers - 30°		

GEARWRENCH® 2 Pc. Push Pin Pliers Set

- 30° and 80° Offset Push Pin Pliers



Cat. No.	UPC No.	Packaging	Product Weight
41840D	082171418402	Carded	0.90 lb

Cat. No.	Description	Cat. No.	Description
3729	Push Pin Removal Pliers - 30°	3888D	Push Pin Pliers - 80°

GEARWRENCH® Push Pin Removal Pliers - 30° Offset

- Specially Designed for Removal of Push Pins With Center Locking Pin
- Quickly Removes Plastic Anchors That Have Center Pins Without Damage to Pins or Anchor
- Tool Lifts the Center Pin and Pulls Anchor in One Simple Step
- Anchors Common on Honda, Toyota, GM, Ford, Chrysler and Many Other Late Model Vehicles
- Fits Into Pin Slots and Under the Center Pin
- Double Cushion Grip Handle
- Tapered End for Easy Access
- 30° Offset

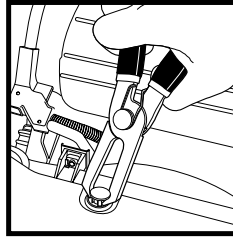

Cat. No.	UPC No.	Packaging	Product Weight
3729	082171037290	Carded	0.45 lb

GEARWRENCH® Push Pin Pliers - 80°

- Specially Designed for Removal of Push Pins With Center Locking Pin
- Quickly Removes Plastic Anchors That Have Center Pins Without Damage to Pins or Anchor
- Tool Lifts the Center Pin and Pulls Anchor in One Simple Step
- Anchors Common on Honda, Toyota, GM, Ford, Chrysler and Many Other Late Model Vehicles
- Fits Into Pin Slots and Under the Center Pin
- Double Cushion Grip Handle
- Tapered End for Easy Access and 80° Offset



Cat. No.	UPC No.	Packaging	Product Weight
3888D	082171388804	Carded	0.45 lb

GEARWRENCH® Panel Clip Pliers

- Features a Unique Two-Step Tip That Provides Better Support Under the Clip Head Than Conventional Panel Clip Pliers
- Added Support Provided by the Two-Step Design Allows Removal of Panel Clips Without Damaging the Clip



Cat. No.	UPC No.	Packaging	Product Weight
3705	082171037054	Carded	0.57 lb

GEARWRENCH® 2 Pc. Hog Ring Pliers Set

- Used for Upholstery Work on Most All Domestic and Foreign Cars
- 45 Degree Hog Ring Plier
- Straight Hog Ring Plier
- For Installation of "Hog Ring" Fasteners
- Specially Made to Grip and Mold Hog Rings for Closure
- Spring Loaded to Hold Hog Ring in Jaws During Use
- Cushion Grip Handle



Cat. No.	UPC No.	Packaging	Product Weight
3702D	082171037023	Carded	1.50 lb

Cat. No.	Description	Cat. No.	Description
3703D	Hog Ring Pliers Straight	3704D	Hog Ring Pliers 45 Degree

GEARWRENCH® Hog Ring Pliers Straight

- Specially Made to Grip and Mold Hog Rings for Closure
- Spring Loaded to Hold Hog Ring in Jaws During Use
- Cushion Grip Handle



Cat. No.	UPC No.	Packaging	Product Weight
3703D	082171037030	Carded	0.75 lb

GEARWRENCH® Hog Ring Pliers 45 Degree

- Used for Upholstery Work on Most All Domestic and Foreign Cars
- 45 Degree for Added Access
- Specially Made to Grip and Mold Hog Rings for Closure
- Spring Loaded to Hold Hog Ring in Jaws During Use
- Cushion Grip Handle



Cat. No.	UPC No.	Packaging	Product Weight
3704D	082171037047	Carded	0.75 lb

GEARWRENCH® Trim Pad Removing Tool

- Tool Reaches Behind Trim Panel on GM and Other Cars
- Grips Plastic Fastener and Removes Trim Without Damage



Cat. No.	UPC No.	Packaging	Description	Product Weight
2822D	082171028229	Carded	Trim Pad Removing Tool	0.22 lb

GEARWRENCH® Door Handle and Window Lift Remover

- Compresses the Door Handle Spring Clip Far Enough so that the Handle can be Removed while the Spring Clip Remains on the Handle
- Use Tool's Reverse End to Disengage Clip Holding Door Upholstery Panels
- Fits GM, Ford and Other Cars Using Type of Clip Shown



Cat. No.	UPC No.	Packaging	Description	Product Weight
431D	082171004315	Carded	Door Handle and Window Lift Remover	0.32 lb

GEARWRENCH® Window Moulding Remover

- Removes Clips and Spreads Rubber Gasket on Chrysler Windows
- Rounded Point Spreads Zipper-Type Gaskets



Cat. No.	UPC No.	Packaging	Description	Product Weight
2037DD	082171020377	Carded	Window Molding Remover	0.18 lb

GEARWRENCH® Window Moulding Remover

- Removes Window Molding Clips on GM, Ford Vehicles
- Place Jaw Flat Against Glass
- Locate Clips and Roll Them Out With Tip, Keeping Jaw Flat to Glass

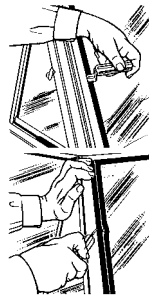

Cat. No.	UPC No.	Packaging	Description	Product Weight
2038D	082171020384	Carded	Window Molding Remover	0.21 lb

GEARWRENCH® Body Dent Remover

- Pulls Dented Sheet Metal Back Into Place
- To Use, Drill a Hole in the Deepest Part of the Dent, Insert the Hook or Self-Threading Screw Tip and Tap Lightly With the 2 Lb Slide Hammer to Remove the Dent
- 16.5" Long Shaft (Including Handle) Enables High Pulling Force
- Slide Hammer Shaft Has a 1/2-20 UNC Thread
- Handle Length: 4.75"



Cat. No.	UPC No.	Packaging	Description	Product Weight
2290D	082171022906	Carded	Body Dent Remover	3.58 lb
229070	082171337451	Bagged	Replacement Part: Hook and Screw Package	0.10 lb
229076	082171337468	Bagged	Replacement Part: Nose Nut	0.06 lb

GEARWRENCH® Deluxe 6" Dent Puller

- Puller Easily Pops Dented Hoods, Doors and Fenders Into Place
- 6" Diameter Suction Disc With Steel Handle and Steel Support Plates Enables Strong Pull
- Works on Nearly Every Dent Where the Sheet Metal Has Not Been Creased
- Lift Edge to Release Suction
- Puller Also Functions as a Glass Holder

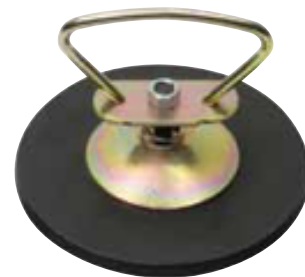

Cat. No.	UPC No.	Packaging	Description	Product Weight
2761D	082171027611	Carded	Deluxe 6" Dent Puller	0.52 lb

GEARWRENCH® Radio Removal & Antenna Wrench Set

- Includes the Tools Needed to Remove the Radio From the Dash on Many Domestic and Import Vehicles Without Damage to the Radio or the Dash Panel
- Antenna Nut Sockets Fit Over Antennas and Down Into Deep Well Locations
- Set Includes: Radio Removal Tool, Key Set, Antenna Nut Socket Set



Cat. No.	UPC No.	Packaging	Description	Product Weight
41680D	082171416804	Boxed	Radio Removal & Antenna Wrench Set	2.06 lb

GEARWRENCH® Mini Scraper

- Use for Light Scraping on Wood, Metal and Glass
- Small Size Allows for Scraping in Confined Areas
- Scraper Includes Plastic Sleeve Handle for Comfort
- Comes in Convenient Standard Pack of 30 in Countertop Merchandiser
- Orders Must Be Placed in Multiples of 30



Cat. No.	UPC No.	Packaging	Description	Product Weight
3390	082171033902	Carded	Mini Scraper	0.10 lb

GEARWRENCH® All-Purpose Scraper and Sticker Remover

- Remove Inspection Stickers, Dealer Price Labels and Paint From Glass
- Tool Locks Into 3 Operating Positions to Reach Hard-To-Get-At Slanting Windshields and Uses Single-Edge Razor Blades
- Cutting Edge Folds Into the Handle for Safe Storage



Cat. No.	UPC No.	Packaging	Description	Product Weight
2106	082171021060	Carded	All-Purpose Scraper and Sticker Remover	0.29 lb

GEARWRENCH® Long Reach Scraper

- 7" Long Reach Scraper is Ideal for Use Where Added Extension is Needed, Such As Deep Recessed Dash Boards in Mini-Vans
- Contains Two Replacement Blades, Including One Plastic Blade Which Will Not Harm Coated Windows
- Replacement Plastic Blade Available



Cat. No.	UPC No.	Packaging	Description	Product Weight
3528D	082171035289	Carded	Extended Long Reach Scraper	0.53 lb
352870	082171990151	Carded	Replacement Plastic Blade	0.02 lb

GEARWRENCH® 15 Pc. Brake Service Set

- Kit Works on both Disc and Drum Brake Systems
- Use to Adjust Clearance Between Drum Brakes And Shoe, Remove and Install Shoe Return Springs and Brake Pads
- Heavy Duty Brake Spreader - Use with Both a 5/16" Socket Wrench or Use By Hand
- Brake Lining Thickness Gauge - Color Coded Brake Gauge Identifies Thickness Levels for Brake Lining Inspection



Cat. No.	UPC No.	Packaging	Description	Product Weight
41520	082171041525	Boxed	15 Pc. Brake Service Set	5.98 lb

Cat. No.	Description	Cat. No.	Description
287D	Drum Brake Adjusting Tool	80421	3/8" Drive Hex Bit Socket, 3/8"
298D	Brake Spring Pliers	80428D	3/8" Drive Hex Bit Socket, 7mm
2774D	Universal Brake Shoe Retaining Spring Tool	80429	3/8" Drive Hex Bit Socket, 8mm
3163D	Disc Brake Piston Tool	80431	3/8" Drive Hex Bit Socket, 10mm
3355D	GM-Ford Disc Brake Piston Tool	80451	3/8" Drive TORX® Press-Fit Bit Socket, T-40
3525D	Heavy Duty Brake Pad Separator	80452	3/8" Drive TORX® Press-Fit Bit Socket, T-45
3962	Brake Lining Thickness	80454	3/8" Drive TORX® Press-Fit Bit Socket, T-50
80419	3/8" Drive Hex Bit Socket, 1/4"		

GEARWRENCH® 11 Pc. Rear Brake Caliper Set

- Designed for Vehicles With Brake Pistons That are Mechanically Tied to the Parking Brake and Require a Turning Action to Push Back
- Set Covers Most Domestic and Import Vehicles



Cat. No.	UPC No.	Packaging	Description	Product Weight
41540	082171041549	Boxed	11 Pc. Rear Brake Caliper Set	5.14 lb

Cat. No.	Description	Cat. No.	Description
41541	Applicator & Pad for Brake Tool	41546D	Adapter 5: 1-3/8", 2 Pin, 3/8" Drive
41542	Adapter 0: 2-1/2", 1 Pin	41547	Adapter 6: 1-5/8", 2 Pin(L)
41543	Adapter 2: 2", 3 Pin	41548D	Adapter 7: 1-5/8", 2 Pin(S)
41544	Adapter 3: 2-1/4", 3 Step	41549D	Adapter 8: 1-7/8", 1 Pin
41545	Adapter 4: 1-1/4", 2 Pin	41550D	Adapter P: 2-1/4", 1 Pin

GEARWRENCH® Brake Spring Pliers

- Tool Easily Removes and Installs Shoe Return Springs on Most Drum Brakes
- Socket End Removes Spring From Anchor Stud and Notched End Installs Spring on Anchor
- Tool is Chrome Plated to Resist Rust and Provides Easy Cleanup



Cat. No.	UPC No.	Packaging	Product Weight
298D	082171002984	Carded	0.90 lb

GEARWRENCH® Bendix Drum Brake Spring Tool

- Tool Removes and Installs Return Spring on Bendix Drum Brakes
- To Use, Place Socket End Over Spring Anchor and Twist to Remove
- Hook Notched End Through Spring and Over the Post, Then Lift to Install



Cat. No.	UPC No.	Packaging	Description	Product Weight
280	082171002809	Carded	Bendix Drum Brake Spring Tool	0.35 lb

GEARWRENCH® Brake Shoe Retaining Spring Tool

- Tool Removes and Installs Retaining Springs 11/16 to 7/8" in Diameter
- Special Socket Grips Retaining Washer
- Push and Turn to Remove or Install



Cat. No.	UPC No.	Packaging	Description	Product Weight
285D	082171002854	Carded	Brake Shoe Retaining Spring Tool	0.25 lb

GEARWRENCH® Drum Brake Adjusting Tool

- Tool Adjusts Clearance Between Drum Brake and Brake Shoe
- Fits Through a Slot in the Backing Plate and Turns the Star Wheel
- Ends of Tool are Offset for Hard-To Reach Areas on Small Cars



Cat. No.	UPC No.	Packaging	Description	Product Weight
295D	082171002953	Carded	Drum Brake Adjusting Tool	0.25 lb

GEARWRENCH® Drum Brake Adjusting Tool

- Tool Adjusts Clearance Between Drum Brake and Brake Shoe
- Fits Through a Slot in the Backing Plate and Turns the Star Wheel



Cat. No.	UPC No.	Packaging	Description	Product Weight
287D	082171002878	Carded	Drum Brake Adjusting Tool	0.25 lb

GEARWRENCH® Universal Brake Shoe Retaining Spring Tool

- Double-Ended Tool Removes and Installs Small and Large Car Drum Brake Retaining Springs
- Tool Fits Sizes 5/8 to 11/16" and 11/16 to 7/8" Diameter Special Sockets Grip Retaining Washers
- Push and Turn to Remove or Install



Cat. No.	UPC No.	Packaging	Description	Product Weight
2774D	082171027741	Carded	Universal Brake Shoe Retaining Spring Tool	0.30 lb

GEARWRENCH® Disc Brake Piston Tool

- Designed to Rotate the Parking-Brake-Activated Piston Back into the Caliper Cylinder When Replacing Worn Pads on Vehicles Equipped With 4-Wheel Disc Brakes
- Tool Will Function on Most Domestic and Import Vehicles
- Caution: Do Not Use With Power Tools



Cat. No.	UPC No.	Packaging	Description	Product Weight
3163D	082171031632	Carded	Disc Brake Piston Tool	0.20 lb

GEARWRENCH® GM-Ford Disc Brake Piston Tool

- Tool Rotates the Piston Back on GM and Ford Vehicles Equipped With Rear Wheel Disc Brakes
- Fits GM Vehicles with 2-1/8 and 1-7/8" Pistons and Ford Vehicles 1987 to Current With Rear Disc Brakes
- Use in Conjunction With 3/8" Square Drive Tool
- Caution: for Intended Use Only



Cat. No.	UPC No.	Packaging	Description	Product Weight
3355D	082171033551	Carded	GM-Ford Disc Brake Piston Tool	0.20 lb

GEARWRENCH® Disc Brake Pad Spreader

- Pushes the Caliper Piston Back on Disc Brakes that do not have the Parking Brake Mechanism as Part of the Disc Brake Caliper
- Caution: for Intended Use Only



Cat. No.	UPC No.	Packaging	Description	Product Weight
3376D	082171033766	Carded	Disc Brake Pad Spreader	0.44 lb

GEARWRENCH® Heavy Duty Brake Pad Separator

- Tool Helps to Move Front Disc Brake Pistons Back Into Position While Installing New Brake Shoes
- Works With Most All Disc Brake Systems With Single Piston Caliper
- Features Heavy Duty Center Screw and Pressure Plate for Extended Use
- Use With a 1/2" Wrench or Socket
- Upgraded With a Knob That Allows for Use With Both a 5/16" Socket Wrench or Use By Hand
- Heavy Duty Plate to Reduce Bending
- Solid Swivel Foot Will Not Collapse or Crush Under Pressure
- Not for Use With an Impact Wrench



Cat. No.	UPC No.	Packaging	Description	Product Weight
3525D	082171035258	Carded	Heavy Duty Brake Pad Separator	0.83 lb

GEARWRENCH® One-Man Brake Bleeder

- Attach Bleeder to Loosened Bleeder Screw and Pump Brake Pedal Until All Air Bubbles are Removed From the Hose
- Two Adapters Fit Most Bleeder Screws and Prevent Leakage While Keeping the Hose in Place

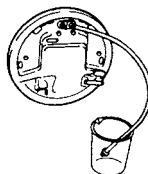

Cat. No.	UPC No.	Packaging	Description	Product Weight
2538D	082171025389	Carded	One-Man Brake Bleeder	0.80 lb

GEARWRENCH® Vacuum Brake Bleeder

- 1 Liter capacity vacuum brake bleeder complete with new fluid supply bottle
- New fluid bottle adaptors set for different master cylinder designs
- 40" bleeder hose for tight access applications
- Flexible rubber joint for fluid extractions (avoids leaks).
- Uses standard workshop air supply



Cat. No.	UPC No.	Packaging	Description	Product Weight
3737D	082171037375	Boxed	Vacuum Brake Bleeder	3.43 lb
3738	082171037382	Boxed	Vacuum Brake Bleeder, Bleeder Only	2.32 lb
3739	082171037399	Boxed	Vacuum Brake Bleeder, Refill Bottle	0.32 lb

GEARWRENCH® Brake Bleeder Tank

- Diaphragm-type Bleeder for Conventional and Anti-Lock Brake Systems Allows for One-Man Operation
- Diaphragm keeps Brake Fluid and Air Separated
- Custom Adaptors Available for Many Makes and Models
- Holds Approximately 4 Gallons
- Includes Combination Quick Coupler plus Automatic Fluid Shut-Off
- Steel Construction
- Caution: For use with DOT 2, 3, 4 and 5 Brake Fluids Only, Not for use with any other Brake / Hydraulic Fluid



Cat. No.	UPC No.	Packaging	Description	Product Weight
3795D	082171037955	Boxed	Brake Bleeder Tank	20.6 lb

Obsolete Part #	Superseded by	Key Features
2222 Brake Bleeder Tank	3795 Brake Bleeder Tank	4 gallon capacity, with wheels and hand post for mobility, disconnect changed to industry standard
2901 Brake Bleeder Tank	2901 Brake Bleeder Tank	Uses new industry standard disconnect - all else the same
3353 Brake Bleeder Adapter	3796 Brake Bleeder Adapter	GM Full-sized cars and trucks
2417 Brake Bleeder Adapter	3789 Brake Bleeder Adapter	Ford Full-sized cars and trucks
3297 Brake Bleeder Adapter	3788 Brake Bleeder Adapter	Domestic and Import Applications
3354 Brake Bleeder Adapter	3787 Brake Bleeder Adapter	GM Vans and Dodge Trucks
New Application	3790 Brake Bleeder Adapter	Many Import Applications
New Application	37951 Brake Bleeder Adapter - 100 Series to 2100 series	Converts classic 2222 brake bleeder tank to new 37XX series master cylinder adapters
New Application	37952 Brake Bleeder Adapter - 2100 Series to 100 series	Converts new 3795 brake bleeder tank to classic KD master cylinder adapters
3294 Brake Bleeder Adapter	No Replacement	
2216 Brake Bleeder Adapter	No Replacement	

GEARWRENCH® Brake Bleeder Tank

- Safe, Portable Tank Fills and Pressurizes Standard and Power Brake Systems
- Operates from Hand Pump Pressure, Eliminating the need for an Air Compressor
- Only a Few Pumps are needed to Build Pressure to 10 to 15 PSI
- Tank is Serviceable and Features Quick Disconnect Coupler and Shut-off Valve that is Used as a Source for Brake Fluid when Topping off Master Cylinders with Brake Bleeder Adapter Attached



Cat. No.	UPC No.	Packaging	Description	Product Weight
2901D	082171029011	Boxed	Brake Bleeder Tank	5.50 lb
222273	082171337147	Boxed	Replacement Part, Pressure Gauge	0.35 lb
222276	082171337161	Bagged	Replacement Part, Quick Disconnect Coupler	0.03 lb
290171	082171291173	Bagged	Replacement Part, O-Ring	0.01 lb
290101	082171291104	Bagged	Replacement Part, Valve	0.15 lb

GEARWRENCH® Brake Bleeder Adapter, 100 Series to 2100 Series

- Converts Classic 2222 and Classic 2901 Brake Bleeder Tank to new 37XX Series Master Cylinder Adapters



Cat. No.	UPC No.	Packaging	Description	Product Weight
37951	082171379512	Boxed	Coupler - Adapts Classic 2222 Brake Bleeder Tank to 3700 Series Master Cylinder Adapters	0.25 lb

GEARWRENCH® Brake Bleeder Adapter, 2100 Series to 100 Series

- Converts 3795D and 2901D Brake Bleeder Tank to classic KD Brand Master Cylinder Adapters



Cat. No.	UPC No.	Packaging	Description	Product Weight
37952	082171379529	Boxed	Coupler - Adapts 3795D Brake Bleeder to Classic Master Cylinder Adapters	0.24 lb

GEARWRENCH® Dual Bleeding Attachment

- Use for Pressurizing Brake Systems when Bleeding Dual Round Top Reservoirs
- Features Quick Disconnect Fittings for Fast Setup
- Adapter for Use With 3795D and 2901D Brake Bleeding Tanks



Cat. No.	UPC No.	Packaging	Description	Product Weight
3787	082171037870	Carded	Dual Bleeding Attachment	0.93 lb

GEARWRENCH® Universal Adapter 3.25" Diameter

- Adapter Pressurizes Brake Systems on Many Applications Across Many Makes
- Use With 3-1/2" Round Reservoirs
- Adapter for use with 3795D and 2901D Brake Bleeding Tanks
- Requires break bleeder adaptor 37951



Cat. No.	UPC No.	Packaging	Description	Product Weight
3788	082171037887	Carded	Brake Bleeder, Universal Adapter 3.25" Diameter	0.97 lb

GEARWRENCH® Universal Adapter 3.75" X 7.75"

- Adapter Pressurizes Brake Systems on Many Applications Across Many Makes
- Use with Rectangular Reservoirs Under 3.75" X 7.75" Common on Trucks and Full Sized Vehicles
- Adapter for use with 3795D and 2901D Brake Bleeding Tanks
- Requires break bleeder adaptor 37951



Cat. No.	UPC No.	Packaging	Description	Product Weight
3789	082171037894	Carded	Brake Bleeder, Universal adapter 3.75" x 7.75"	3.86 lb

GEARWRENCH® Universal Round Adapter 4-1/8"

- Adapter Pressurizes Brake Systems on Many Applications Across Many Makes
- Use with 4-1/8" Round Reservoirs
- Adapter for use with 3795D and 2901D Brake Bleeding Tanks
- Requires break bleeder adaptor 37951



Cat. No.	UPC No.	Packaging	Description	Product Weight
3790D	082171037900	Carded	Brake Bleeder, Universal Round adapter 4-1/8"	2.23 lb

GEARWRENCH® GM Bypass Adapter

- Adapter Pressurizes Brake Systems on Most GM Applications
- For use with 3795D and 2901D Brake Bleeding Tanks
- Caution: for Intended Use Only
- Requires break bleeder adaptor 37951



Cat. No.	UPC No.	Packaging	Description	Product Weight
3796	082171037962	Carded	GM Bypass adapter	1.18 lb

GEARWRENCH® Tubing Service Set

- For Tubing Service
- Broad Tubing Application Including Double Flare, Bend, Cut, Ream, and Deburr



Cat. No.	UPC No.	Packaging	Description	Product Weight
41590D	082171041594	Boxed	Tubing Service Set	3.70 lb

Cat. No.	Description	Cat. No.	Description	Cat. No.	Description
2107D	Mini Tubing Cutter	3905D	Deburring Tool	41595	Holding Bar
2189D	Tubing Bender	41594	7 Pc. Flaring Adapter Kit	41596	Yoke For Flaring Tool

GEARWRENCH® Combined Double / Bubble Flaring Tool Kit

- Complete Double and Bubble Flaring Tool Assortment
- Slots on Yoke Firmly Engage with Bar Assembly
- Includes Corresponding Adapters for Forming Double Flares
- Forged Alloy Steel and Hardened
- Precisely Flares Tubing Up to 0.040" Wall Thickness to SAE/ Metric 45° Flares
- Hardened Bar Assembly Clamps 11 Tubing Sizes: 3/16", 1/4", 5/16", 3/8", 7/16", 5/8", 1/2", 47, 6, 8, and 10mm
- Additional Set Contents: SAE Bar Assembly, Metric Bar Assembly, Yoke Assembly, Reamer, Cutter, 3/16" Flaring Tool Adapter, 1/4" Flaring Tool Adapter, 5/16" Flaring Tool Adapter, 3/8" Flaring Tool Adapter, 7/16" Flaring Tool Adapter, 1/2" Flaring Tool Adapter, 5/8" Flaring Tool Adapter, 4.7 mm Flaring Tool Adapter, 6mm Flaring Tool Adapter, 8mm Flaring Tool Adapter, 10mm Flaring Tool Adapter, and Cutter



Cat. No.	UPC No.	Packaging	Description	Product Weight
41880D	082171418808	Boxed	Combined Double / Bubble Flaring Tool Kit	7.35 lb

Cat. No.	Description	Cat. No.	Description	Cat. No.	Description
2107D	Mini Tubing Cutter	41592	Dual SAE and Metric Bar Assembly	41597	Universal Yoke
3905D	Deburring Tool	41593	10 Pc. Double Flaring Adapter Set	41599	4 Pc. Bubble Flaring Adapter Kit

GEARWRENCH® Double Flaring Tool Kit

- Complete Double Flaring Tool Assortment
- Slots on Yoke Firmly Engage with Bar Assembly
- Includes Corresponding Adapters for Forming Double Flares
- Forged Alloy Steel and Hardened
- Precisely Flares Tubing Up to 0.040" Wall Thickness to SAE 45° Flares
- Hardened Bar Assembly Clamps 7 Tubing Sizes: 3/16", 1/4", 5/16", 3/8", 7/16", 5/8", and 1/2"
- Do Not Use on Stainless Steel Tubing
- Additional Set Contents: SAE Bar Assembly, Yoke Assembly, Reamer, 3/16" Flaring Tool Adapter, 1/4" Flaring Tool Adapter, 5/16" Flaring Tool Adapter, 3/8" Flaring Tool Adapter, 7/16" Flaring Tool Adapter, 1/2" Flaring Tool Adapter, and 5/8" Flaring Tool Adapter



Cat. No.	UPC No.	Packaging	Description	Product Weight
41860	082171418600	Carded	Double Flaring Tool Kit (replaces 2199 & 3869)	4.05 lb

Cat. No.	Description	Cat. No.	Description
3905D	Deburring Tool	41595	Holding Bar
41594	7 Pc. Flaring Adapter Kit	41597	Universal Yoke

GEARWRENCH® Bubble Flaring Tool Kit

- Complete Bubble Flaring Tool Assortment
- Slots on Yoke Firmly Engage with Bar Assembly
- Includes Corresponding Adapters for Forming Double Flares
- Forged Alloy Steel and Hardened
- Precisely Flares Tubing Up to 0.040" Wall Thickness to Metric 45° Flares
- Hardened Bar Assembly Clamps 4 Tubing Sizes: 4.7, 6, 8, & 10mm
- Do Not Use on Stainless Steel Tubing
- Additional Set Contents: Metric Bar Assembly, Yoke Assembly, Reamer, 47mm Flaring Tool Adapter, 6mm Flaring Tool Adapter, 8mm Flaring Tool Adapter, and 10mm Flaring Tool Adapter



Cat. No.	UPC No.	Packaging	Description	Product Weight
41870	082171418709	Carded	Bubble Flaring Tool Kit (replaces 3482)	4.35 lb

Cat. No.	Description	Cat. No.	Description
3905D	Deburring Tool	41598D	Bubble Flaring Tool Holding Bar
41597	Universal Yoke	41599	4 Pc. Bubble Flaring Adapter Kit

GEARWRENCH® Mini Tubing Cutter

- Cut Thin-Wall Steel, Plastic, Copper and Brass Tubing From 1/8 to 5/8" in Diameter
- Two Rollers Provide Burr-Free Cut
- Small Size Allows Cutter to Fit Into Tight Areas

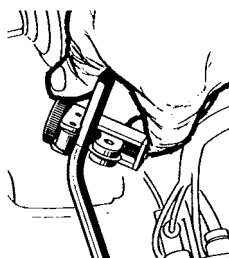

Cat. No.	UPC No.	Packaging	Description	Product Weight
2107D	082171021077	Carded	Mini Tubing Cutter	0.21 lb

GEARWRENCH® Tubing Bender

- Bend 3/16, 1/4, 5/16, and 3/8" Diameter Tubing Without Kinking
- Heavy-Duty Construction Provides Years of Service



Cat. No.	UPC No.	Packaging	Description	Product Weight
2517D	082171025174	Carded	Tubing Bender	0.60 lb

GEARWRENCH® Tubing Bender

- Bend 3/16", 1/4", 5/16" and 3/8" Copper and Steel Tubing
- Tool Makes Tight Bends without the Tube Collapsing
- Roller Adapters are Included for each Tubing Size
- Place Tubing Between the Adapter and Studs and Squeeze the Handles to Bend



Cat. No.	UPC No.	Packaging	Description	Product Weight
2189D	082171021893	Carded	Tubing Bender	1.17 lb

GEARWRENCH® Deburring Tool

- Deburring Tool for Removing Rough Edges for Better Flaring Tube Fit



Cat. No.	UPC No.	Packaging	Description	Product Weight
3905D	082171390500	Carded	Deburring Tool	0.15 lb

GEARWRENCH® Brake Cylinder Hone

- Tool Hones Drum Brake Wheel Cylinders and Disc Brake Calipers From 3/4 to 2-1/2" (19 to 64mm) in Diameter
- Sleeve Makes Insertion in Cylinder Easy and Protects Stones When Not in Use
- Use with a Variable-Speed Drill
- Use 2004D Stone Set for Disc Brake Honing and 266 for Drum Brake Honing

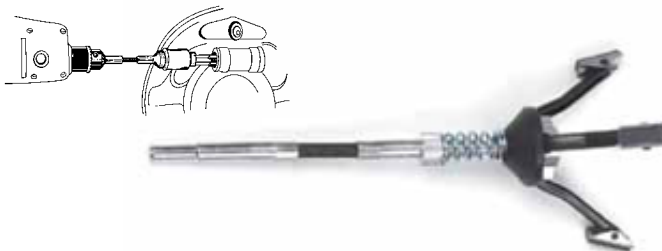

Cat. No.	UPC No.	Packaging	Description	Product Weight
265D	082171002656	Carded	Brake Cylinder Hone	0.25 lb

GEARWRENCH® Replacement Stones

- Stones Fit Brake Cylinder Hones 265D, 2544 and 267



Cat. No.	UPC No.	Packaging	Description	Product Weight
2004D	082171020049	Carded	3 Replacement Stones for Converting 3-Legged 265D or 2544 Cylinder Hone to Disc Brake Hone; Size 400, 3/4"	0.32 lb
266	082171002663	Carded	3 Replacement Stones for 265D or 2544 Drum Brake Cylinder Hone; Size 320, 1-1/8"	0.23 lb

GEARWRENCH® Economy Brake and Engine Cylinder Hone Set

- Multi-Purpose Set Includes 3 Complete Hones and 1 Set of 2" Stones
- Complete Hone for Brake, Master and Wheel Cylinders 3/4 through 2-1/2" Capacity, with 1-1/8" Medium-Grit Stones
- Complete Hone for Small Car Brake Wheel Cylinders 1/2 Through 1-3/4" Capacity, with Two 1-1/8" Medium-Grit Stones
- Complete Hone for Disc Brake Caliper Honing. 1-1/4" Through 3-1/2" Capacity, with 3/4" Medium-Grit Stones; also Ideal for Lawn and Garden Small-Engine Cylinder Honing when used with Three 2" Medium-Grit Stones (Included)
- Replacement Part: 3029-75 Three 2" Cylinder Hone Stones



Cat. No.	UPC No.	Packaging	Description	Product Weight
3029	082171030291	Carded	Economy Brake and Engine Cylinder Hone Set	0.60 lb
302975	082171318313	Carded	Replacement Part, Three 2" Cylinder Hone Stones	0.11 lb

GEARWRENCH® Brake Lining Thickness Gauge

- Color Coded Brake Gauge Identifies Thickness Levels for Brake Lining Inspection
- Metric - 8, 10, & 12mm (Green), 4, 5, 6mm (Yellow), 2 & 3mm (Red)
- SAE - 0.3150 to 0.4720" (Green), 0.1575 to 0.2382" (Yellow), 0.0787 to 0.1181" (Red)



Cat. No.	UPC No.	Packaging	Description	Product Weight
3962	082171396205	Carded	Brake Lining Thickness	0.58 lb

GEARWRENCH® Disc Brake Lining Wear Gauge

- Gauge Measures Brake Lining Remaining on Bonded Pads in Fractions From 1/16" to 5/8" in 1/32" Graduations
- Tool Checks Measurement Without Removing Caliper
- Tool is Patented

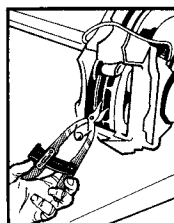

Cat. No.	UPC No.	Packaging	Description	Product Weight
2116D	082171021169	Carded	Disc Brake Lining Wear Gauge	0.20 lb

GEARWRENCH® Brake Lining Gauge, Wide Band

- Gauge Measures Bonded Brake Lining From 0 to 1/2" in 1/64" Graduations
- Place Gauge Over Brake Shoe to Take Reading

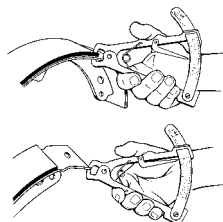

Cat. No.	UPC No.	Packaging	Description	Product Weight
2324D	082171023248	Carded	Brake Lining Gauge	0.35 lb

GEARWRENCH® Tire Tread And Brake Lining Gauge

- Measure the Amount of Lining Remaining on Riveted Drum Shoes and Disc Brake Pads
- Gauge Measures Tire Tread Depth Up to 9/16" in Graduations of 1/64"

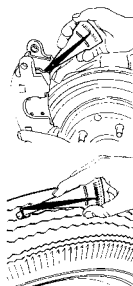

Cat. No.	UPC No.	Packaging	Description	Product Weight
2326D	082171023262	Carded	Tire Tread and Brake Lining Gauge	0.20 lb

GEARWRENCH® Brake Resetting Gauge

- Used to Set the Proper Clearance Between Brake Lining and Drum Prior to Assembly
- Inside Calipers Measure Drum Diameters and Outside Calipers Transfer Measurement to Brake Shoes
- Knurled Knob Locks Tool at Measurement
- Diameter Range: 6-1/2" to 14-1/4"
- Calibrated in 1/32" (1mm) Increments



Cat. No.	UPC No.	Packaging	Description	Product Weight
3377	082171033773	Carded	Brake Resetting Gauge	1.50 lb

GEARWRENCH® 6" Digital Caliper with Large LCD window

- LCD Displays Up to 5 Digits
- Glass Window Over LCD is Clearer and Does Not Wear Out
- Color Coded Off, On/Zero and Inch/mm
- Stainless Steel Frame with Hardened Jaws, Graduated
- Scale and Thumb Roll
- 4 Way Measurement, Inside, Outside, Depth & Step
- Resolution / Repeatability 0.001" X 0.01mm
- Data Output Interface
- Fitted in a Plastic Box



Cat. No.	UPC No.	Packaging	Product Weight
3756D	082171037566	Boxed	0.76 lb

GEARWRENCH® Dial Indicator Set with On/Off Stand

- English Dial Gauge Range: 0-1.3", Gradations: 0.001"
- Centered V-Magnet for Strongest Grip on Round or Flat Surfaces
- Powerful 130 Lbs. Pull
- Two Magnetic Mounting Surfaces: Bottom and Back
- Swivel Adapter to Mount All Agd Dial Indicators with Lug Backs
- Universal Dovetail Clamp for Dial Test Indicators
- On / Off Switch
- Center Rod 1/2" Diameter X 7" High



Cat. No.	UPC No.	Packaging	Product Weight
3761	082171037610	Boxed	4.64 lb

GEARWRENCH® Electronic Digital Rotor Micrometer

- Manual Power On/Off
- 0-1.3", (0-76mm) Grad. 0.001"
- 3-1/2" Deep Throat
- Metric/Inch System Interchange at Any Position
- Zero Setting at Any Position
- With Data Output Interface
- Measures Thickness of Inside Grooves
- Fitted in a Plastic Box



Cat. No.	UPC No.	Packaging	Product Weight
3763	082171037634	Boxed	3.72 lb

GEARWRENCH® Digital Brake Rotor Gauge

- 0 to 6"
- Manual Power On/Off
- Metric/Inch System Interchange at Any Position
- Zero Setting at Any Position
- Data Output Interface
- Measure Wear Dimension of the Brake Rotors
- Resolution / Repeatability 0.0005" X 0.01mm
- Storage Case

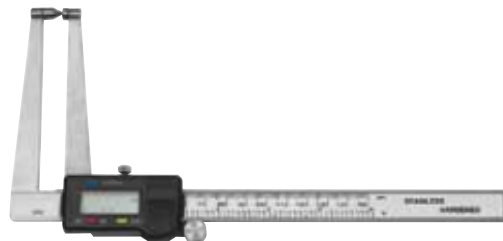

Cat. No.	UPC No.	Packaging	Product Weight
3774D	082171037740	Boxed	1.01 lb

GEARWRENCH® Digital Brake Drum Gauge

- 3" to 16"
- Preset at 1-1/2" Depth with Indicators for 0.5" and 1"
- Manual Power On/Off
- Metric/Inch System Interchange at Any Position
- Zero Setting at Any Position
- Data Output Interface
- Measure Wear Dimension of the Brake Drum
- Resolution / Repeatability 0.0005" X 0.01mm
- Storage Case



Cat. No.	UPC No.	Packaging	Product Weight
3777	082171037771	Boxed	4.06 lb

GEARWRENCH® Axle Nut Set

■ 7 Extra Long 1/2" Drive 6 Point Metric Sockets are Ideal for Heavy-Duty Use in Removing and Installing Axle Nuts Use With a Ratchet, Breaker Bar, Impact Wrench, or Torque Wrench



Cat. No.	UPC No.	Packaging	Description	Product Weight
41650	082171416507	Boxed	Axle Nut Set	12.39 lb

Cat. No.	Description	Cat. No.	Description
3907D	29mm Deep 1/2" Dr. Deep Axle Nut Socket, GM & Ford	3908D	35mm Deep 1/2" Dr. Deep Axle Nut Socket, GM
3161D	30mm Deep 1/2" Dr. Deep Axle Nut Socket, GM	3162D	36mm Deep 1/2" Dr. Deep Axle Nut Socket, GM
3270D	32mm Deep 1/2" Dr. Deep Axle Nut Socket, Honda/Chrysler	3909D	38mm Deep 1/2" Dr. Deep Axle Nut Socket, GM & Ford
3449D	34mm Deep 1/2" Dr. Deep Axle Nut Socket, GM		

GEARWRENCH® Axle Nut Sockets

■ These 7 Extra Long 1/2" Drive 6 Point Metric Sockets are Ideal for Heavy-Duty use in Removing and Installing Axle Nuts
 ■ Use with a Ratchet, Breaker Bar, Impact Wrench, or Torque Wrench



Cat. No.	UPC No.	Packaging	Description	Product Weight
3907D	082171390708	Carded	29mm Deep 1/2" Dr. Deep Axle Nut Socket, GM & Ford	0.80 lb
3161D	082171031618	Carded	30mm Deep 1/2" Dr. Deep Axle Nut Socket, GM	1.25 lb
3270D	082171032707	Carded	32mm Deep 1/2" Dr. Deep Axle Nut Socket, Honda/Chrysler	1.45 lb
3449D	082171034497	Carded	34mm Deep 1/2" Dr. Deep Axle Nut Socket, GM	1.55 lb
3908D	082171390807	Carded	35mm Deep 1/2" Dr. Deep Axle Nut Socket, GM	1.76 lb
3162D	082171031625	Carded	36mm Deep 1/2" Dr. Deep Axle Nut Socket, GM	2.05 lb
3909D	082171390906	Carded	38mm Deep 1/2" Dr. Deep Axle Nut Socket, GM & Ford	2.22 lb

GEARWRENCH® 4WD Spindle Puller with Internal Threads

■ Removes Front Spindle to Access Needle Bearing When Lubricating and Aligning Front Wheels
 ■ 5/8"-18 Fine Thread Permits Use With Slide Hammer
 ■ Fits Spindle Thread Sizes 2"-16, 1-5/8"-16, and 38mm-15
 ■ Applications: Full-Size GM, Ford, Jeep and International Pickups With Dana Front Axles, Plus Ranger and Bronco II



Cat. No.	UPC No.	Packaging	Description	Product Weight
3910D	082171391002	Carded	4WD Spindle Puller	0.80 lb

GEARWRENCH® Spindle Nut Set

- 6 Chrome Vanadium Steel 1/2" Drive Sockets are for Most 4WD SUV's and Light Truck Axle Locknut Applications
- Use With a Torque Wrench, Ratchet, or Breaker Bar



Cat. No.	UPC No.	Packaging	Description	Product Weight
41660D	082171416606	Boxed	Spindle Nut Set	13.48 lb

Cat. No.	Description	Cat. No.	Description
2467	4-Lug 4WD Spindle Nut Socket, 1/2 to 3/4 Ton Dana 44	3910D	4WD Spindle Puller
2770D	6-Lug 4WD Spindle Nut Socket, 3/4 to 1 Ton Dana 44	3911D	Toyota Lock Nut Tool
3195D	4-Lug Socket with Extension 1/2 Ton Dana 80	3937	4-Lug 4WD Spindle Nut Socket 1/2 Ton Dana 50

GEARWRENCH® 4-Wheel-Drive Spindle Nut Wrench

- Removes Spindle Nuts on 4-Wheel Drive Vehicles
- Features Uniquely Designed Lugs for Maximum Strength
- Use With 1/2" Square Drive Tool
- Will Work on Ford Vehicles With Ratcheting Type Lock Nuts on Front Axle
- Caution: Do not use with Power Tools



Cat. No.	UPC No.	Packaging	Description	Product Weight
2467	082171024672	Carded	4-Lug 4WD Spindle Nut Socket, 1/2 to 3/4 Ton Dana 44	1.35 lb
2770D	082171027703	Carded	6-Lug 4WD Spindle Nut Socket, 3/4 to 1 Ton Dana 44	1.50 lb
3246D	082171032462	Carded	4-Wheel-Drive Spindle Nut Wrench, Dana Axle or Dana 50IFS	1.80 lb

GEARWRENCH® Toyota Lock Nut Tool



Cat. No.	UPC No.	Packaging	Description	Product Weight
3911D	082171391101	Carded	Toyota Lock Nut Tool	0.80 lb

GEARWRENCH® 55mm Lock Nut - 1/2 Drive



Cat. No.	UPC No.	Packaging	Description	Product Weight
3912D	082171391200	Carded	55mm Lock Nut - 1/2 Drive	0.80 lb

GEARWRENCH® 4-Lug 4WD Spindle Nut Socket 1/2 Ton Dana 50

- Remove and Install 4-Slot Front Axle Locknuts on 1981-97 Ford F250-350, Bronco With Dana Axle, or Dana 50lfs or Model 60 Monobeam Axle Outer Adjusting Nut; 1982-90 GM Heavy Duty 3/4- and 1-Ton Trucks



Cat. No.	UPC No.	Packaging	Description	Product Weight
3937	082171393709	Carded	4-Lug 4WD Spindle Nut Socket 1/2 Ton Dana 50	1.02 lb

GEARWRENCH® Ford Spindle Nut Wrench

- Specially Designed Wrench Removes Ford High-Shear Ratcheting Lock Nut on Popular F250/350 Series Trucks
- Special Feature Includes a Centering Snout to Help Locate Special Axle Nut and Uniquely Designed Lugs for Maximum Strength
- Use With 1/2" Drive Tool
- Applications: 1985 and newer Ford F250-350 With Dana 80 Rear Axle, and 10 1/4" Ring Gear, 1987 E350 and newer with Dana 80 Rear Axle and 10 1/4" Ring Gear, 1988 and newer F Super Duty With Dana 80 Rear Axle and 10 1/4" Ring Gear
- Caution: Do not use with Power Tools



Cat. No.	UPC No.	Packaging	Description	Product Weight
3195D	082171031953	Carded	4-Lug Socket with Extension 1/2 Ton Dana 80	2.03 lb

GEARWRENCH® Bearing Race and Seal Set

- Install Tapered Bearing Races and Seals Without Damage to the Component or Housing
- Includes a Driver Handle Plus 9 Popular Bearing and Seal Drivers Ranging From 1.565" to 3.180"



Cat. No.	UPC No.	Packaging	Description	Product Weight
41630D	082171416309	Boxed	Bearing Race and Seal Set	4.74 lb

Cat. No.	Description	Cat. No.	Description
41631D	Driver Handle	41636D	2.470" Driver
41632	1.565" Driver	41637	2.555" Driver
41633	1.750" Driver	41638	2.830" Driver
41634	1.961" Driver	41639	2.995" Driver
41635	2.325" Driver	41640	3.180" Driver

GEARWRENCH® Hand Bearing Packer

- Self-Contained Bearing Packer Saves Time and Can Be Used Anywhere
- No Air Line or Grease Gun Required
- Packs 50 to 60 Bearings Without Refilling
- Transparent, Impact Resistant Cup Allows Grease Level Check
- Use on All Cage-Type Roller and Ball Bearings Up to 2" Bore



Cat. No.	UPC No.	Packaging	Description	Product Weight
2775D	082171027758	Carded	Hand Bearing Packer	0.90 lb

GEARWRENCH® Wheel Weight Tool

- Tool Installs, Removes, Trims and Tightens All Types of Clip-On Wheel Weights
- It Features a Special Plastic-Type Material on the Hammer Head for Safe, Mar-Free Installation of Specially Coated Wheel Weights Used on Alloy Wheels
- Tool Has a Plastics-Dipped Handle for Comfort
- Replacement Part: 335804 Plastic Tip
- Caution: for Intended Use Only

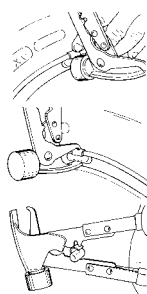

Cat. No.	UPC No.	Packaging	Description	Product Weight
3358	082171033582	Carded	Wheel Weight Tool	1.10 lb
335804	082171335808	Carded	Replacement Plastic Tip	0.23 lb

GEARWRENCH® 8 Pc. SAE/Metric Stud Removal Set

- Complete SAE and Metric Stud Remover Set Offers the Best Professional Extractors Available
- Designed and Tested to Reach Studs in Difficult Work Areas



Cat. No.	UPC No.	Packaging	Description	Product Weight
41760D	082171417603	Boxed	8 Pc. SAE/Metric Stud Removal Set	2.55 lb

Cat. No.	Description	Cat. No.	Description
41761	6mm Removal Socket 3/8" Drive	41768D	1/4" Removal Socket 3/8" Drive
41762D	8mm Removal Socket 3/8" Drive	41767D	5/16" Removal Socket 3/8" Drive
41763D	10mm Removal Socket 1/2" Drive	41765	3/8" Removal Socket 1/2" Drive
41764	12mm Removal Socket 1/2" Drive	41766	7/16" Removal Socket 1/2" Drive

GEARWRENCH® Stud Removal Sockets

Cat. No.	UPC No.	Packaging	Description	Product Weight
41761	082171417610	Bagged	6mm Removal Socket 3/8" Drive	0.15 lb
41762D	082171417627	Bagged	8mm Removal Socket 3/8" Drive	0.15 lb
41763D	082171417634	Bagged	10mm Removal Socket 1/2" Drive	0.15 lb
41764	082171417641	Bagged	12mm Removal Socket 1/2" Drive	0.15 lb
41765	082171417658	Bagged	3/8" Removal Socket 1/2" Drive	0.15 lb
41766	082171417665	Bagged	7/16" Removal Socket 1/2" Drive	0.15 lb
41767D	082171417672	Bagged	5/16" Removal Socket 3/8" Drive	0.15 lb
41768D	082171417689	Bagged	1/4" Removal Socket 3/8" Drive	0.15 lb



GEARWRENCH® Universal Nut Cracker

- Splits Most Stubborn Nuts 7/16" (11mm) Through 3/4" (19mm) Across the Flats
- Works in Channels Not Accessible to Other Tools
- Parallel Action of Pusher Cracks Nuts Without Damaging Bolt Threads
- Chisel Rotates 360° to Line Up Parallel to Bolt
- Simply Tighten the Screw Until the Nut Splits Has Rugged Drop-Forged Frame
- Do Not Use on Heat-Treated Nuts
- Length: 6-3/4"
- This is a Serviceable Product



Cat. No.	UPC No.	Packaging	Description	Product Weight
715D	082171007156	Carded	Universal Nut Cracker	1.50 lb
71575D	082171715754	Bagged	Replacement Plunger	0.05 lb
71574	082171715747	Bagged	Replacement Chisel	0.25 lb
71573D	082171715730	Bagged	Replacement Ball Bearings	0.01 lb

GEARWRENCH® 6 Pc. 3/8" Drive Impact Driver Set

- Free Frozen Bolts and Screws by Twisting the Tool in the Direction of the Rotation and Holding while Striking with a Hammer
- Reverse Action to Tighten Bolts
- Set is Standard 3/8" Square Drive and includes a 3/8" Square Drive Adapter for 5/16" Hex Bits
- Four-bit Set includes No. 2 and No. 3 Phillips Bits and 5/16" and 9/32" Slotted Bits

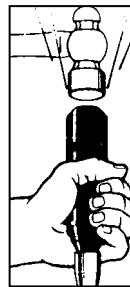

Cat. No.	UPC No.	Packaging	Description	Product Weight
1140D	082171011405	Carded	6 Pc. 3/8" Drive Impact Driver Set	1.53 lb
412402	082171412424	Bagged	No. 2 Phillips Insert Bit 5/16" Dr.	0.05 lb
412403	082171412400	Bagged	Replacement No. 3 Phillips Insert Bit 5/16" Dr.	0.01 lb
412406	082171412462	Bagged	Replacement 6-8 Slotted Insert Bit 5/16" Dr.	0.01 lb
412410	082171412417	Bagged	Replacement 8-10 Slotted Insert Bit 5/16" Dr.	0.01 lb

GEARWRENCH® Stud Extractor

- Removes 1/4" (6mm) to 3/4" (19mm) Studs
- Cam Wheel Grips Within 9/32" of Flat Surface to Hold Stud
- Drive Socket Will Not Bind
- Use 1/2" Square Drive Tools to Operate



Cat. No.	UPC No.	Packaging	Description	Product Weight
1708DD	082171017087	Carded	Stud Extractor	0.85 lb

GEARWRENCH® Pro Swivoil™ Filter Wrench

- 180 Degree Swivel Action
- Cushion Grip Dual Material Handle Provides Greater Comfort and Better Gripping Force
- Stainless and Plated Steel Material Band for Lifetime Corrosion Resistance
- Dimpled for Extra Gripping Power
- Specially Designed to Fit Today's Oil Filters



Cat. No.	UPC No.	Packaging	Description	Min Diameter	Max Diameter	Product Weight
3941	082171394102	Carded	Pro Swivoil™ Filter Wrench - Small	2.52 in, 64 mm	2.99 in, 76 mm	1.20 lb
3942	082171394201	Carded	Pro Swivoil™ Filter Wrench - Medium	2.87 in, 73 mm	3.27 in, 83 mm	1.30 lb
3943	082171394300	Carded	Pro Swivoil™ Filter Wrench - Large	3.50 in, 89 mm	3.90 in, 99 mm	1.30 lb
3944	082171394409	Carded	Pro Swivoil™ Filter Wrench - Extra Large	3.78 in, 96 mm	4.37 in, 111 mm	1.40 lb

GEARWRENCH® Swivoil™ Filter Wrench

- Wrenches are Made of High-Quality Steel With a Zinc-Plated Yoke and a Blackened Band for Resistance to Rust and Corrosion
- Plastisol-Dipped Handle will not Slide Off During Use
- Even Hard-To-Reach Oil Filters Will Come Off Easily with this Swivel-Handle Oil Filter Wrench
- Unique Yoke and Link Assembly Allows a Good Grip, but will not Crush the Filter
- Swivel Tension is Adjusted Easily by Using the Nut and Bolt on the Handle

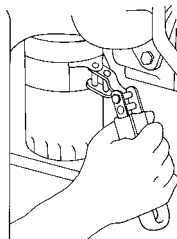

Cat. No.	UPC No.	Packaging	Description	Min Diameter	Max Diameter	Product Weight
3324D	082171033247	Carded	Swivoil™ Filter Wrench - Small	2.50 in, 64 mm	3.00 in, 76 mm	0.70 lb
3083D	082171030833	Carded	Swivoil™ Filter Wrench - Medium	2.88 in, 73 mm	3.25 in, 83 mm	0.70 lb
3082D	082171030826	Carded	Swivoil™ Filter Wrench - Large	3.50 in, 89 mm	3.88 in, 98 mm	0.75 lb
3527	082171035272	Carded	Swivoil™ Filter Wrench - Extra Large	3.88 in, 96 mm	4.38 in, 111 mm	0.80 lb

GEARWRENCH® Universal Oil Filter Wrench

- Wrench Removes Oil Filters 3-7/16" to 3-3/4" (87 to 95mm) in Diameter
- Its Positive Grip Lets You Exceed Normal Torque Requirements
- The Band Will Not Puncture or Crush Filter

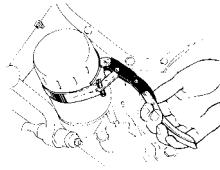

Cat. No.	UPC No.	Packaging	Description	Min Diameter	Max Diameter	Product Weight
190	082171001901	Carded	Universal Oil Filter Wrench	3.44 in, 87 mm	3.75 in, 95 mm	0.65 lb

GEARWRENCH® Oil Filter Wrench

- Wrench Remove Oil Filters 3-1/16" to 3-7/16" (78 to 87mm) in Diameter
- Positive Grip Lets You Exceed Normal Torque Requirements
- Band Will Not Puncture or Crush Filter

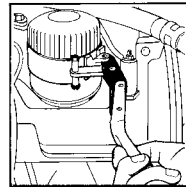

Cat. No.	UPC No.	Packaging	Description	Min Diameter	Max Diameter	Product Weight
191	082171001918	Carded	Oil Filter Wrench	3.06 in, 78 mm	3.44 in, 87 mm	0.55 lb

GEARWRENCH® Fuel and Oil Filter Wrench

- Wrench Removes Gasoline and Oil Filters 2-1/4" to 2-9/16" (57 to 65mm) in Diameter
- Design Prevents Crushing of the Filter Case



Cat. No.	UPC No.	Packaging	Description	Min Diameter	Max Diameter	Product Weight
192	082171001925	Carded	Fuel and Oil Filter Wrench (2-1/4" to 2-9/16")	2.25 in, 57 mm	2.56 in, 65 mm	0.55 lb

GEARWRENCH® Adjustable Oil Filter Wrench

- Notched Link Set to 1 to 3 Positions - Removes Oil Filters From 2-3/4" to 3-3/4" (70 to 95mm) in Diameter
- Wide Range of Sizes Makes this Wrench Very Universal



Cat. No.	UPC No.	Packaging	Description	Min Diameter	Max Diameter	Product Weight
2187D	082171021879	Carded	Adjustable Oil Filter Wrench (2-3/4" to 3-3/4")	2.75 in, 70 mm	3.75 in, 95 mm	0.58 lb

GEARWRENCH® Truck and Tractor Oil Filter Wrench

- Removes Oil Filters 4" to 4-3/8" (102 to 111mm) in Diameter Found on Most Tractors and Trucks
- Positive Grip Lets You Exceed Normal Torque Requirements Band Will Not Crush Filters



Cat. No.	UPC No.	Packaging	Description	Min Diameter	Max Diameter	Product Weight
2010D	082171020100	Carded	Truck and Tractor Oil Filter Wrench (4" to 4-3/8")	4.00 in, 102 mm	4.38 in, 111 mm	0.70 lb

GEARWRENCH® Square Drive Oil Filter Wrench

- For Hard-To-Reach Areas, Use This Wrench in Place of 190 to Remove Filters 3-7/16" to 3-3/4" (87 to 95mm) in Diameter
- To Use, Turn Filter With 3/8" Square Drive Tools Band Will Not Crush Filter
- Caution: Do Not Use With Power Tools

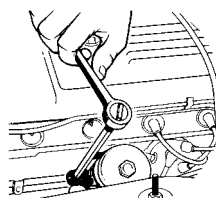

Cat. No.	UPC No.	Packaging	Description	Min Diameter	Max Diameter	Product Weight
2029DD	082171020292	Carded	Square Drive Oil Filter Wrench (3-7/16" to 3-3/4")	3.44 in, 87 mm	3.75 in, 95 mm	0.48 lb

GEARWRENCH® 5 Pc. Oil Filter End Cap Wrench Set

- Provides High Torque Capacity
- Handles 140 Ft.-Lbs. of Torque to Remove Even the Most Stubborn Filters
- Competitive Filter Cap Wrenches Do Not Even Come Close to this Capacity
- Metal Drive Insert Will Not Deform or Break Even After Years of Service
- Set Comes in Blow Mold Case



Cat. No.	UPC No.	Packaging	Description	Product Weight
3865	082171038655	Carded	5 Pc. Oil Filter End Cap Wrench Set in Case	1.25 lb

Cat. No.	Description	Cat. No.	Description
3860D	Oil Filter End Cap Wrench, 14 Flute, 65/67mm Plastic	3863	Oil Filter End Cap Wrench, 15 Flute, 93mm Plastic
3861D	Oil Filter End Cap Wrench, 15 Flute, 74/76mm Plastic	3864D	Oil Filter End Cap Wrench, 36 Flute, 76/80/93mm Plastic
3862D	Oil Filter End Cap Wrench, 14 Flute, 76mm Plastic		

GEARWRENCH® Filter Cap Wrenches

- Provides High Torque Capacity
- Handles 140 Ft.-Lbs. of Torque to Remove Even the Most Stubborn Filters
- Competitive Filter Cap Wrenches Do Not Even Come Close to this Capacity
- Metal Drive Insert Will Not Deform or Break Even After Years of Service



Cat. No.	UPC No.	Packaging	Description	Product Weight
3860D	082171038600	Carded	Oil Filter End Cap Wrench, 14 Flute, 65/67mm Plastic	0.25 lb
3861D	082171038617	Carded	Oil Filter End Cap Wrench, 15 Flute, 74/76mm Plastic	0.25 lb
3862D	082171038624	Carded	Oil Filter End Cap Wrench, 14 Flute, 76mm Plastic	0.25 lb
3863	082171038631	Carded	Oil Filter End Cap Wrench, 15 Flute, 93mm Plastic	0.25 lb
3864D	082171038648	Carded	Oil Filter End Cap Wrench, 36 Flute, 76/80/93mm Plastic	0.25 lb

GEARWRENCH® 65mm End Cap Oil Filter Wrench

- Wrench Removes and Installs 14-Flute, 65mm Factory Oil Filters on Late-Model Toyota Tercel, Mr2, Celica and 1988 Camry
- Use With A
- 3/8" Drive Tool or a 1" Wrench



Cat. No.	UPC No.	Packaging	Description	Product Weight
3253D	082171032530	Carded	65mm End Cap Oil Filter Wrench	0.30 lb

GEARWRENCH® 3" End Cap Oil Filter Wrench

- Specially Designed Wrench Removes and Installs Hard-To-Reach 3" (76mm) Oil Filters with a 15-Flute End
- Fits Various Flute Designs Found on AC/Delco, Fram, Wix, Step, NAPA, Sears, Gard, Motorcraft and Other Filters
- Use with 3/8" Square Drive Tool or a 1" Wrench
- Durable Steel Wrench is Zinc Plated to Resist Rust
- Be Sure Fluted End of Filter Matches Wrench
- Caution: Do Not Use With Power Tools

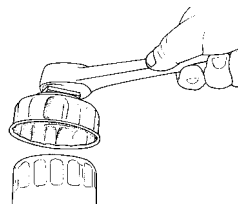

Cat. No.	UPC No.	Packaging	Description	Product Weight
2790D	082171027901	Carded	3" End Cap Oil Filter Wrench	0.45 lb

GEARWRENCH® 3-3/4" End Cap Oil Filter Wrench

- Wrench Removes and Installs 3-3/4" (95mm) Diameter Filters with 15-Flute Ends
- Designed for use with a 3/8" Square Drive Tool or a 1" Wrench
- Tool is Zinc Plated to Resist Rust
- Be Sure Fluted End of Filter Matches Wrench



Cat. No.	UPC No.	Packaging	Description	Product Weight
2991D	082171029912	Carded	3-3/4" End Cap Oil Filter Wrench	0.50 lb

GEARWRENCH® Adjustable Oil Filter Wrench Pliers

- Pliers Cover a Complete Range of Filter Removal From 2" to 5" (50mm to 125mm) in Diameter
- Ratchet and Lock Mechanism Allow for Multiple Settings for Sure Fit, Eliminating Slippage
- Jaws are Grooved for Better Holding of the Filter
- Forged for Superior Strength
- Plastisol Coated Handles Provide a Firm Grip



Cat. No.	UPC No.	Packaging	Description	Min Diameter	Max Diameter	Product Weight
3508D	082171035081	Carded	Oil Filter Pliers - Ratcheting (2" to 5")	2.00 in, 50 mm	5.00 in, 125 mm	1.17 lb

GEARWRENCH® Oil Filter Wrench Pliers

- Pliers Remove Stubborn, Stuck Filters
- Unique, Dual-Handle Styling Allows for Better Leverage to Bear Down Harder
- Tool is Forged for Superior Strength and Double Dipped Handles Provide a Firm Grip



Cat. No.	UPC No.	Packaging	Description	Min Diameter	Max Diameter	Product Weight
3369	082171033698	Carded	Slip Joint Oil Filter Wrench Plier (2-3/4" to 3-1/8")	2.75 in	3.13 in	1.20 lb
3368	082171033681	Carded	Slip Joint Oil Filter Wrench Plier (2-15/16" to 3-5/8")	2.31 in	3.63 in	1.25 lb
3369F	082171336904	Carded	Fixed Joint Oil Filter Wrench Plier (2-1/2" to 3-1/4")	2.50 in	3.25 in	1.16 lb
3368F	082171336805	Carded	Fixed Joint Oil Filter Wrench Plier (2-11/16" to 3-3/4")	2.69 in	3.75 in	1.22 lb

GEARWRENCH® Heavy Duty Oil Filter Wrenches, Wide Band

- Extra Wide 3" Band for Better Grip and Reduced Canister Damage
- Not for Use With Impact Guns



Cat. No.	UPC No.	Packaging	Description	Min Diameter	Max Diameter	Product Weight
2320W	082171232008	Carded	Wide Heavy Duty Oil Filter Wrench (4-1/8" to 4-1/2")	4.13 in, 105 mm	4.50 in, 115 mm	0.45 lb
2321W	082171232107	Carded	Wide Heavy Duty Oil Filter Wrench (4-3/8" to 5-1/4")	4.38 in, 110 mm	5.25 in, 130 mm	0.55 lb
2322W	082171232206	Carded	Wide Heavy Duty Oil Filter Wrench (4-3/4" to 5-1/2")	4.75 in, 120 mm	5.50 in, 140 mm	0.65 lb

GEARWRENCH® Heavy-Duty Oil Filter Wrenches

- Wrenches are Designed for High Torque Requirements of Truck Filters and Used With 1/2" Square Drive Tools
- 1-1/2" Wide Bands for Added Strength and Increased Grip Area
- Caution: Do Not Use With Power Tools



Cat. No.	UPC No.	Packaging	Description	Min Diameter	Max Diameter	Product Weight
2320D	082171023200	Carded	Heavy Duty Oil Filter Wrench (3-3/4" to 4-1/2")	3.75 in, 95 mm	4.50 in, 115 mm	2.00 lb
2321	082171023217	Carded	Heavy Duty Oil Filter Wrench (4-1/2" to 5-1/4")	4.50 in, 115 mm	5.25 in, 135 mm	2.10 lb
2322D	082171023224	Carded	Heavy Duty Oil Filter Wrench (5-1/4" to 5-3/4")	5.25 in, 135 mm	5.75 in, 150 mm	2.54 lb

GEARWRENCH® Universal 3-Jaw Oil Filter Wrench

- Remove All Passenger Car and Light-Duty Truck Spin-On Type Filters With This Wrench
- Sizes Range From 2-1/2" to 3-3/4"
- Use With 3/8" Square Drive Tool

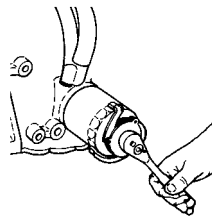

Cat. No.	UPC No.	Packaging	Description	Min Diameter	Max Diameter	Product Weight
3288D	082171032882	Carded	Universal 3-Jaw Oil Filter Wrench	2.50 in	3.75 in	0.50 lb

GEARWRENCH® Chain Wrench, 1/2" Square Drive

- To Effectively Apply Torque, Wrap Tool Around Any Shape Item From 5/8" to 5" (16 to 127mm) in Diameter
- Turn With 1/2" Square Drive Tools
- Chain Length - 16-1/4"

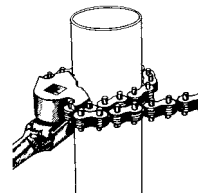

Cat. No.	UPC No.	Packaging	Description	Min Diameter	Max Diameter	Product Weight
2595D	082171025952	Carded	Chain Wrench, 1/2" Drive	0.63 in, 16 mm	5.00 in, 127 mm	1.73 lb

GEARWRENCH® Nylon Strap Oil Filter Wrench

- Use Wrench on Oil Filters Up to a 6" (152mm) Diameter
- Strong Nylon Belt Will Not Slip
- Use With 1/2" Square Drive Tools

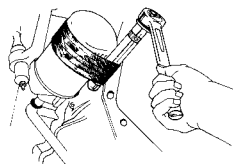

Cat. No.	UPC No.	Packaging	Description	Max Diameter	Product Weight
3149	082171031496	Carded	Nylon Strap Oil Filter Wrench, 1/2" Drive	6.00 in, 152 mm	0.50 lb

GEARWRENCH® Heavy Duty Oil Filter Strap Wrench

- Strap is Made of High Strength Oil Resistant Nylon and Handle is Made of Forged Steel
- Chrome Plated 3/8" and 1/2" Drive Engagement
- Handles Filters With Diameters Up to 9" (229mm) Especially High Torque Requirements on Truck and Tractors



Cat. No.	UPC No.	Packaging	Description	Max Diameter	Product Weight
3529D	082171035296	Carded	Heavy Duty Oil Filter Strap Wrench, 3/8" or 1/2" Drive	9.00 in, 229 mm	0.67 lb

GEARWRENCH® 6 Pc. Oil Canister Socket Set Service Kit

- Low Profile Sockets for Better Access



Cat. No.	UPC No.	Packaging	Description	Product Weight
41890	082171418907	Boxed	6 Pc. Oil Canister Socket Set Service Kit	2.08 lb

Cat. No.	Description	Cat. No.	Description	Cat. No.	Description
3935	24mm Oil Filter Socket	3936	29mm Oil Filter Socket	3934D	36mm Oil Filter Socket
3933D	27mm Oil Filter Socket	3932D	32mm Oil Filter Socket	3939D	38mm Oil Filter Socket

GEARWRENCH® 3 Pc. Oil Canister Socket Set

- Low Profile Sockets for Better Access



Cat. No.	UPC No.	Packaging	Description	Product Weight
41830	082171418303	Boxed	3 Pc. Oil Canister Socket Set	1.15 lb

Cat. No.	Description	Cat. No.	Description	Cat. No.	Description
3933D	27mm Oil Filter Socket	3932D	32mm Oil Filter Socket	3934D	36mm Oil Filter Socket

GEARWRENCH® Oil Filter Sockets

- Low Profile Sockets for Better Access

Cat. No.	UPC No.	Packaging	Description	Product Weight
3935	082171039355	Carded	24mm Oil Filter Socket	0.22 lb
3933D	082171393303	Carded	27mm Oil Filter Socket	0.25 lb
3936	082171039362	Carded	29mm Oil Filter Socket	0.27 lb
3932D	082171393204	Carded	32mm Oil Filter Socket	0.30 lb
3934D	082171393402	Carded	36mm Oil Filter Socket	0.35 lb
3939D	082171039393	Carded	38mm Oil Filter Socket	0.45 lb



GEARWRENCH® 7 Pc. Magnetic Oil Drain Plug Socket Set

- Oil Drain Plug Sockets have Magnetic Core and Surface Drive™ Technology
- Knurled "Speed Ring" provides quick removal and installation
- Serrated edges provide added grip for hard-to-reach fasteners
- Anodized color-coded aluminum
- Fits most domestic and import vehicles
- Set comes with Pass-Thru® Ratchet featuring GearRatchet™ handle



Cat. No.	UPC No.	Packaging	Product Weight
3870D	082171387050	Retail Packaging	2.43 lb

Cat. No.	Description	Cat. No.	Description
235080GR	3/8" (20 mm) GearRatchet® Handle	3875D	16 mm Magnetic Oil Drain Plug Socket
3872D	13 mm Magnetic Oil Drain Plug Socket	3876D	17 mm Magnetic Oil Drain Plug Socket
3873D	14 mm Magnetic Oil Drain Plug Socket	3877D	19 mm Magnetic Oil Drain Plug Socket
3874D	15 mm Magnetic Oil Drain Plug Socket		

GEARWRENCH® 6 Pc. Magnetic Oil Drain Plug Socket Set

- Oil Drain Plug Sockets have Magnetic Core and Surface Drive™ Technology
- Knurled "Speed Ring" provides quick removal and installation
- Serrated edges provide added grip for hard-to-reach fasteners
- Anodized color-coded aluminum
- Fits most domestic and import vehicles
- Can be used with Pass-Thru® Ratchets featuring GearRatchet™ handles, or 3/8" Drive Ratchets



Cat. No.	UPC No.	Packaging	Product Weight
3871D	082171387159	Blow Mold Case	2.20 lb

Cat. No.	Description	Cat. No.	Description
3872D	13 mm Magnetic Oil Drain Plug Socket	3875D	16 mm Magnetic Oil Drain Plug Socket
3873D	14 mm Magnetic Oil Drain Plug Socket	3876D	17 mm Magnetic Oil Drain Plug Socket
3874D	15 mm Magnetic Oil Drain Plug Socket	3877D	19 mm Magnetic Oil Drain Plug Socket

GEARWRENCH® Magnetic Oil Drain Plug Sockets

- Oil Drain Plug Sockets have Magnetic Core and Surface Drive™ Technology
- Knurled "Speed Ring" provides quick removal and installation
- Serrated edges provide added grip for hard-to-reach fasteners
- Anodized color-coded aluminum
- Fits most domestic and import vehicles
- Can be used with Pass-Thru® Ratchets featuring GearRatchet™ handles, or 3/8" Drive Ratchets



Cat. No.	UPC No.	Packaging	Description	Product Weight
3872D	082171387265	Retail Packaging	13 mm Magnetic Oil Drain Plug Socket	0.150 lb
3873D	082171387364	Retail Packaging	14 mm Magnetic Oil Drain Plug Socket	0.150 lb
3874D	082171387494	Retail Packaging	15 mm Magnetic Oil Drain Plug Socket	0.155 lb
3875D	082171387548	Retail Packaging	16 mm Magnetic Oil Drain Plug Socket	0.160 lb
3876D	082171387661	Retail Packaging	17 mm Magnetic Oil Drain Plug Socket	0.165 lb
3877D	082171387760	Retail Packaging	19 mm Magnetic Oil Drain Plug Socket	0.180 lb

GEARWRENCH® Steering Service Set

- Can Remove a Steering Wheel From Most Domestic and Import Cars With or Without Telescoping Tilt Columns
- Use the Puller Legs With the Steering Wheel Puller to Remove Steering Wheels on Late Model GM Vehicles
- Steering Wheel Lock-Plate Depressor also Included



Cat. No.	UPC No.	Packaging	Description	Product Weight
41620D	082171416200	Boxed	Steering Service Set	4.36 lb

Cat. No.	Description	Cat. No.	Description
2291D	Crankshaft Pulley Puller (Steering Wheel Puller)	-	Lock Plate Depressor Frame
3509D	Steering Wheel Lock Plate Remover	-	Lock Plate Remover Collars & Nut Washer
3510D	Steering Wheel Puller Legs	-	Screw Package
3906D	Steering Wheel Pivot Pin		

GEARWRENCH® Steering Wheel Puller Legs

- Use with 2291D Steering Wheel Puller to Remove Steering Wheels on Vehicles that are not Pre-Drilled to Receive Standard Bolts

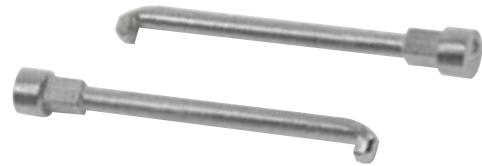

Cat. No.	UPC No.	Packaging	Product Weight
3510D	082171035104	Carded	0.40 lb

GEARWRENCH® Steering Wheel Lock-Plate Remover and Installer

- Fits GM Cars with S.I.R. Air Bags
- Works on Older GM, Chrysler, and AMC Vehicles Previously Serviced by Part # 2414
- Narrower Yoke Prevents Damage to the Lock Plate
- Separate SAE (black) and Metric (zinc) Threaded Collars Screw to the Center Steering Column
- Center Screw Uses a 3/8" Wrench
- Supplied Hex Screw Locks Down Telescoping Steering Columns while Removing Lock Plate
- Hex Screw can be Stored on Side of Puller Yoke



Cat. No.	UPC No.	Packaging	Product Weight
350971	082171509711	Bagged	0.63 lb
350972	082171509728	Bagged	0.54 lb
3509D	082171035098	Carded	1.30 lb

GEARWRENCH® Pivot Pin Remover

- Tilt Steering Columns are Much Easier to Service When Your Tool Box Has One of These Pivot Pin Removers in It
- Works on 1969-Current GM, Chrysler, and Ford Vehicles With Saginaw Steering Columns

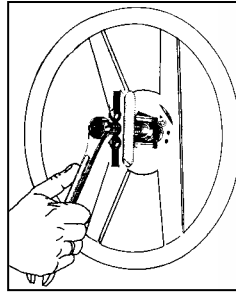

Cat. No.	UPC No.	Packaging	Product Weight
3906D	082171390609	Carded	0.15 lb

GEARWRENCH® Front End Service Set

- Allows for Easy Removal of the Most Popular Types of Pitman Arms, Tie Rods, and Ball Joints



Cat. No.	UPC No.	Packaging	Description	Product Weight
41690	082171416903	Boxed	Front End Service Set	12.65 lb

Cat. No.	Description	Cat. No.	Description
2289D	Pitman Arm Puller	-	Tie Rod Puller
3916D	Universal Ball Joint Separator	-	Universal Tie Rod End Remover
3917D	Tie Rod End Puller and Pitman Arm Puller		

GEARWRENCH® Indexing Ball Joint and Tie Rod Separator Set

- Pneumatic and Manual Hammer Attachment
- Indexing Feature for Access and Leverage when Prying Suspension Components Apart
- Index to 90° to Strike Hammer Surface with Hand Safely Out of Way
- Dipped Grip on Manual Hammer Attachment to Absorb Shock and Eliminate Slip
- Blowmold Case for Storage



Cat. No.	UPC No.	Packaging	Description	Product Weight
43990	082171439902	Boxed	Indexing Ball Joint and Tie Rod Separator Set	5.43 lb

GEARWRENCH® Indexing Ball Joint Separator

- Pneumatic and Manual Hammer Attachment
- Indexing Feature for Access and Leverage when Prying Ball Joint Components Apart
- Index to 90° to Strike Hammer Surface with Hand Safely Out of Way
- Dipped Grip on Manual Hammer Attachment to Absorb Shock and Eliminate Slip



Cat. No.	UPC No.	Packaging	Description	Product Weight
3990	082171039904	Boxed	Indexing Ball Joint Separator - 15/16"	3.25 lb

GEARWRENCH® Indexing Tie Rod Separator

- Pneumatic and Manual Hammer Attachment
- Indexing Feature for Access and Leverage when Prying Tie Rod Components Apart
- Index to 90° to Strike Hammer Surface with Hand Safely Out of Way
- Dipped Grip on Manual Hammer Attachment to Absorb Shock and Eliminate Slip



Cat. No.	UPC No.	Packaging	Description	Product Weight
3991	082171039911	Boxed	Indexing Tie Rod Separator - 21/32"	3.20 lb

GEARWRENCH® Ball Joint Separator

- Tool Separates Ball Joints From Steering Knuckles
- To Use, Insert 15/16" Opening Between Parts and Strike With Hammer
- Separator is Forged to Withstand Hard Usage
- Overall Length: 12"



Cat. No.	UPC No.	Packaging	Description	Product Weight
2287D	082171022876	Boxed	Ball Joint Separator	1.99 lb

GEARWRENCH® Tie Rod Separator

- Powerful Tool Separates Tie Rods
- Insert 21/32" Opening Between Parts and Strike With Hammer to Separate
- Separator is Forged to Withstand Hard Usage
- Overall Length: 12"
- Caution: for Intended Use Only

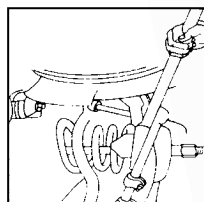

Cat. No.	UPC No.	Packaging	Description	Product Weight
2288D	082171022883	Carded	Tie Rod Separator	2.02 lb

GEARWRENCH® Universal Ball Joint Separator

- For Separating the Ball Joint From the Spindle Support Arm on Domestic and Import Front Wheel Drive Vehicles
- Adjustable for Different Size Ball Joints
- 1-1/8" & 2-1/8" (30 & 56mm) Maximum Opening Capacity



Cat. No.	UPC No.	Packaging	Description	Product Weight
3916D	082171391606	Carded	Universal Ball Joint Separator	1.13 lb

GEARWRENCH® Tie Rod End Puller and Pitman Arm Puller

- Use As a Pitman Arm Remover for Many Small Domestic Rear Wheel Drive Vehicles, or as a Tie Rod End Puller for Many Domestic and Import Vehicles
- 1-1/16" & 2-1/8" (27 & 56mm) Maximum Opening Capacity



Cat. No.	UPC No.	Packaging	Description	Product Weight
3917D	082171391705	Carded	Tie Rod End Puller and Pitman Arm Puller	1.00 lb

GEARWRENCH® Deluxe Inner Tie Rod Tool

- Remove and Install Inner Tie Rods on Many GM and Some Chrysler Products That Have a Complete Hex With a Ball Socket or Just 2 Flats on the Inner End That Measure 1-7/16" Across
- Tool Can Also Be Used on All Inner Tie Rods With 1-3/16" and 1-5/16" Hex Sizes



Cat. No.	UPC No.	Packaging	Description	Product Weight
3312D	082171033124	Carded	Deluxe Inner Tie Rod Tool	2.57 lb

GEARWRENCH® Pitman Arm Puller

- Puller Removes Full-Size Pitman Arms
- To Use, Mount Jaws Over Pitman Arm and Turn Center Screw with Wrench Until Tight
- Strike Center Screw with Hammer to Release Pitman Arm
- No Other Tools are Needed
- Puller Has a Drop-Forged and Heat-Treated Steel Yoke
- Screw Size 5/8"-18 Thread



Cat. No.	UPC No.	Packaging	Product Weight
2289D	082171022890	Carded	1.95 lb

GEARWRENCH CV Boot Clamp Tool

- Allows for Proper Installation of C Boot
- Crimps Joints While With Center Pushing Feature
- Works With Hand, 1/2" Drive Ratchets, or Torque Wrench
- High Leverage Design



Cat. No.	UPC No.	Packaging	Description	Product Weight
3955	082171039553	Carded	Replacement Part CV Boot Clamp (replaces 424)	1.25 lb

GEARWRENCH Macpherson Strut Spring Compressor

- Use This Tough Tool for Quick and Easy Replacement of Struts, Springs and Shock Absorbers
- Compress Springs Both On or Off the Vehicle With Hand or Power Tools
- Maximum Capacity: 6" OD
- Wire Diameter: 5/8"
- Caution: Follow Instructions Provided With This Tool

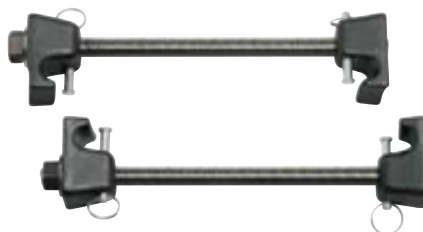

Cat. No.	UPC No.	Packaging	Description	Product Weight
3387	082171033872	Carded	Macpherson Strut Spring Compressor	6.47 lb

GEARWRENCH Coil Spring Compressor

- Use Tool to Remove and Install Automotive Coil Springs Up to 5-5/8" Outside Diameter
- Designed to Grasp a Spring With a Maximum 3/4" Wire Diameter
- Can Be Used on Straight or Curved Springs
- Forged Alloy Steel Arms Hug Contour of Helix
- Caution: Read All Instructions Carefully Before Using This Tool
- Caution: For Intended Use Only
- Caution: Do Not Use With Power Tools



Cat. No.	UPC No.	Packaging	Description	Product Weight
3450D	082171034503	Carded	Coil Spring Compressor	4.55 lb
345071	082171450716	Bagged	Replacement Clip	0.55 lb

GEARWRENCH CV Joint Boot Clamp Tightening Wrench

- Works by Hand or Ratchet with 1/2" Socket
- Includes Built in Cutter
- Use Wrench to Securely Fasten Band-It® Style Free End Clamps, Roll Band and Clips or Band-It Jr® Style Pre-Formed C Boot Clamps
- Mandrel Tightens the Clamp, Holding it in Place Until the Ears of the Clamp are Folded Down
- Use Built in Cutter to Remove Excess Band Material

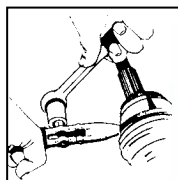

Cat. No.	UPC No.	Packaging	Description	Product Weight
3191D	082171031915	Carded	CV Joint Boot Clamp Tightening Wrench	0.55 lb

GEARWRENCH® Ramo-Matic Zerk Fitting Tool

- Tool Clears Grease Fittings of Hardened Matter
- Fits Straight and Angled Zerk-Type Fittings
- To Use, Fill With Oil or Grease, Hold Against Zerk Fitting and Strike With a Hammer to Clear Away Debris



Cat. No.	UPC No.	Packaging	Description	Product Weight
416D	082171004162	Carded	Ramo-Matic Zerk Fitting Tool	0.40 lb

GEARWRENCH® Hydraulic Clutch Quick Disconnect Tool

- Used to Release Fingers that Hold Clutch Line to the Clutch Sleeve Cylinders
- Works on Hard to Access Couplings Found on Ford Light-Duty Trucks, Ranger, Explorer and 1989 and Newer Thunderbird and Cougar Vehicles with Hydraulic Clutch

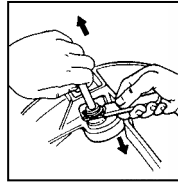

Cat. No.	UPC No.	Packaging	Description	Product Weight
3413D	082171034138	Carded	Ford Clutch Coupling Tool	0.11 lb

GEARWRENCH® Automatic Transmission Clutch-Spring Compressor

- Compresses Automatic-Transmission Clutch Springs on Some GM, Ford, Toyota and other Transmissions
- Permits Easy Removal and Installation of Snap Rings
- Job Can Be Completed Without Removing Center Shaft and Clutch Assembly from Transmission Housing
- To Use, Force Legs in and Catch Jaws Inside Transmission Drum Groove
- Loosen Wing Nuts and Adjust Pushers
- Tighten Screw Until Lock Ring is Free to Be Removed



Cat. No.	UPC No.	Packaging	Description	Product Weight
2398D	082171023989	Boxed	Automatic Transmission Clutch-Spring Compressor	3.55 lb

GEARWRENCH® 10 Pc. Clutch Aligning Set

- Align Single Disc Clutches on American and Imported Cars, Light Trucks and Tractors
- Adapter Fits Through Clutch Plate and into Pilot Bushing or Bearing
- Tapered Cone Fits Into Clutch Hole and Aligns Clutch Plate Properly
- Set Includes Shaft and 8 Two-Stepped Pilot Bearing Adapters Covering 16 Sizes
- Plate Aligning Cone has 1-1/8" Maximum Diameter Taper. Pilot Bushing Cone Taper 0.734" to 1.17" (18.64mm to 29.72mm)
- Zinc Adapters for Import 0.472" & 0.500" (12mm & 12.7mm), 0.622" & 0.641" (15.8mm & 16mm), 0.688" & 0.710" (17.4mm & 18mm), 0.826" & 0.875" (21mm & 22.2mm)
- Black Adapters for Domestic 0.561" & 0.590" (14.2mm & 15mm), 0.749" & 0.787" (19mm & 20mm), 0.812" & 0.874" (20.6mm & 22.2mm), 0.984" & 1.181" (25mm & 30mm)



Cat. No.	UPC No.	Packaging	Description	Product Weight
2420D	082171024207	Boxed	Clutch Aligning Set	2.08 lb

GEARWRENCH® Seal and Pilot Bearing Puller

- Hooked End Removes Seals and Pilot Bearings without Breaking
- Roll Hook Under Edge of Seal and Hit Striking Block With Hammer
- Hook Can Be Used on Slide Hammer for Frozen Seals
- Puller Has 1/2"-13 UNC Threads
- Puller is Not Recommended for Caged Needle Bearings
- Damage to Caged Needle Bearings May Occur

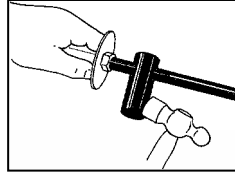

Cat. No.	UPC No.	Packaging	Description	Product Weight
2824D	082171028243	Carded	Seal and Pilot Bearing Puller	1.55 lb

GEARWRENCH® Seal Puller

- Use Tool to Remove Oil and Grease Seals on Automobiles and Light Trucks
- Puller Has 2 Tip Sizes for Most Applications
- To Use, Insert Tip Behind Seal and Use Leverage to Remove
- Caution: Do Not Use As a Striking Tool
- For Intended Use Only

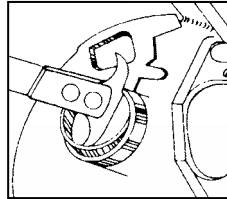

Cat. No.	UPC No.	Packaging	Description	Product Weight
3245	082171032455	Carded	Seal Puller	0.55 lb

GEARWRENCH® Snap Ring Assortment

- Starter Assortment Includes 107 Different Size Internal and External Snap Rings in a Molded Plastic Case
- Actual-Size Silhouette Chart in the Lid Makes Identification Easy
- Ideal Assortment for Jobbers and Dealers to Keep on Hand
- Refills are Available
- Overall Case Size: 18 X 13 X 2-1/2"



Cat. No.	UPC No.	Packaging	Description	Product Weight
2550D	082171025501	Boxed	Snap Ring Assortment	6.10 lb

GEARWRENCH® Snap Rings

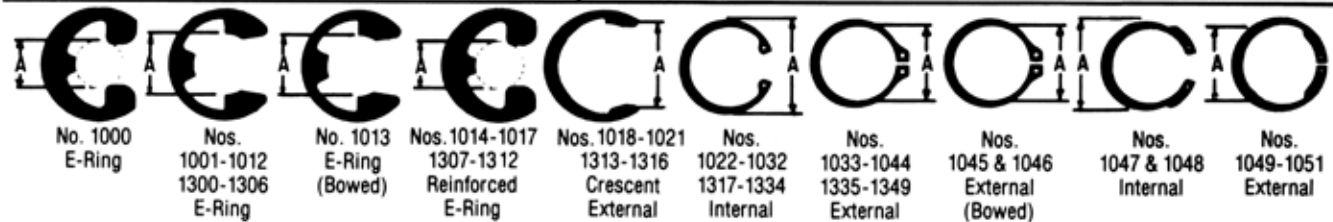
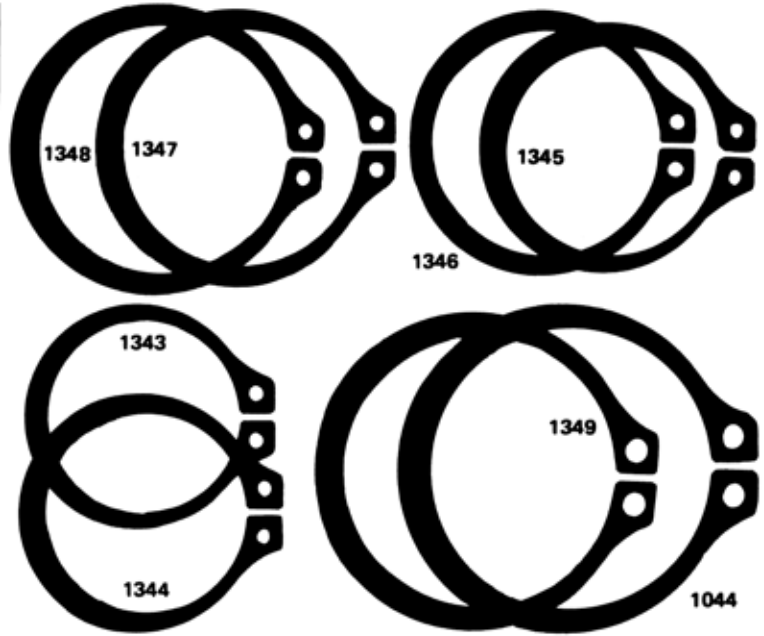
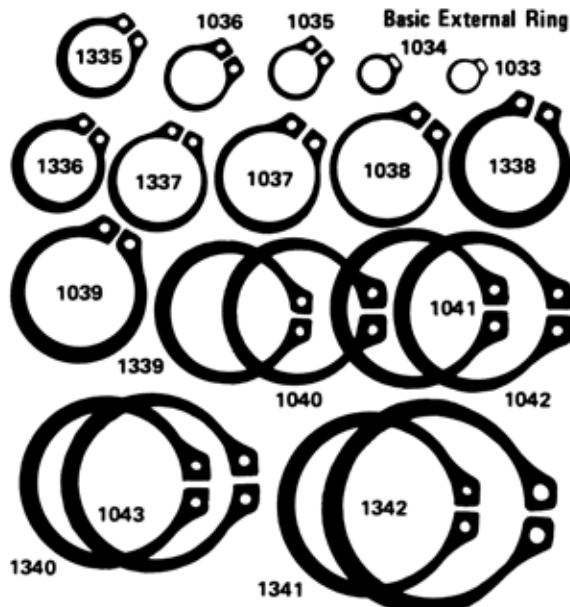

Cat. No.	Shaft Dia.	Housing Dia.	Free Dia. (A)	Cat. No.	Shaft Dia.	Housing Dia.	Free Dia. (A)	Cat. No.	Shaft Dia.	Housing Dia.	Free Dia. (A)
1000DDD	5/32 in	-	0.113 in	1036D	5/16 in	-	0.281 in	1320D	-	0.688 in	0.763 in
1001D	7/64 in	-	0.076 in	1037D	1/2 in	-	0.461 in	1321D	-	0.777 in	0.859 in
1002D	1/8 in	-	0.094 in	1038D	0.551 in	-	0.509 in	1322D	-	0.812 in	0.901 in
1003DD	5/32 in	-	0.114 in	1039D	5/8 in	-	0.579 in	1323D	-	0.901 in	1.000 in
1004D	3/16 in	-	0.145 in	1040D	11/16 in	-	0.635 in	1324D	-	0.920 in	1.020 in
1005D	3/16 in	-	0.122 in	1041D	3/4 in	-	0.693 in	1325DD	-	0.938 in	1.041 in
1006D	7/32 in	-	0.185 in	1042D	25/32 in	-	0.722 in	1326D	-	0.970 in	1.100 in
1007D	1/4 in	-	0.207 in	1043D	27/32 in	-	0.780 in	1327D	-	1.125 in	1.249 in
1008D	5/16 in	-	0.243 in	1044D	1-9/16 in	-	1.446 in	1328D	-	1.181 in	1.319 in
1009D	3/8 in	-	0.300 in	1045D	25/32 in	-	0.722 in	1329D	-	1.218 in	1.344 in
1010D	7/16 in	-	0.337 in	1046	1-1/4 in	-	1.156 in	1330	-	1.312 in	1.456 in
1011D	1/2 in	-	0.392 in	1047D	-	1 in	1.081 in	1331D	-	1.438 in	1.596 in
1012D	5/8 in	-	0.480 in	1048	-	1-1/8 in	1.217 in	1332D	-	1.562 in	1.734 in
1013D	1/2 in	-	0.392 in	1049D	1/2 in	-	0.461 in	1333D	-	1.625 in	1.804 in
1014D	1/4 in	-	0.204 in	1050D	3/4 in	-	0.693 in	1334D	-	1.812 in	2.012 in
1015D	5/16 in	-	0.242 in	1051DD	1-1/8 in	-	1.041 in	1335D	0.375 in	-	0.338 in
1016D	3/8 in	-	0.292 in	1300D	0.062 in	-	0.051 in	1336D	0.438 in	-	0.395 in
1017D	9/16 in	-	0.430 in	1301D	0.093 in	-	0.073 in	1337	0.469 in	-	0.428 in
1018D	7/32 in	-	0.188 in	1302D	0.093 in	-	0.069 in	1338D	0.562 in	-	0.521 in
1019D	3/8 in	-	0.328 in	1303D	0.140 in	-	0.102 in	1339D	0.669 in	-	0.621 in
1020D	1/2 in	-	0.441 in	1304D	0.187 in	-	0.122 in	1340D	0.812 in	-	0.751 in
1021D	5/8 in	-	0.553 in	1305D	0.171 in	-	0.125 in	1341D	0.875 in	-	0.810 in
1022D	-	7/16 in	0.482 in	1306D	0.750 in	-	0.574 in	1342D	1.000 in	-	0.925 in
1023D	-	5/8 in	0.694 in	1307D	0.093 in	-	0.072 in	1343D	1.062 in	-	0.982 in
1024D	-	3/4 in	0.831 in	1308D	0.125 in	-	0.093 in	1344D	1.125 in	-	1.041 in
1025D	-	7/8 in	0.971 in	1309D	0.156 in	-	0.113 in	1345D	1.188 in	-	1.098 in
1026D	-	1 in	1.111 in	1310D	0.187 in	-	0.143 in	1346D	1.250 in	-	1.156 in
1027D	-	1.023 in	1.136 in	1311D	0.219 in	-	0.182 in	1347D	1.312 in	-	1.214 in
1028D	-	1-1/16 in	1.180 in	1312D	0.500 in	-	0.385 in	1348D	1.375 in	-	1.272 in
1029D	-	1-1/4 in	1.388 in	1313D	0.187 in	-	0.161 in	1349D	1.500 in	-	1.387 in
1030D	-	1-3/8 in	1.526 in	1314D	0.250 in	-	0.211 in	1350	-	0.437 in	-
1031D	-	1-1/2 in	1.660 in	1315D	0.437 in	-	0.386 in	1351D	-	0.500 in	-
1032D	-	1-3/4 in	1.941 in	1316D	0.750 in	-	0.665 in	1352D	-	1.437 in	-
1033	5/32 in	-	0.142 in	1317D	-	0.375 in	0.415 in	1353D	-	-	0.437 in
1034D	3/16 in	-	0.168 in	1318D	-	0.512 in	0.560 in	1354D	-	-	0.615 in
1035D	1/4 in	-	0.225 in	1319D	-	0.562 in	0.620 in				

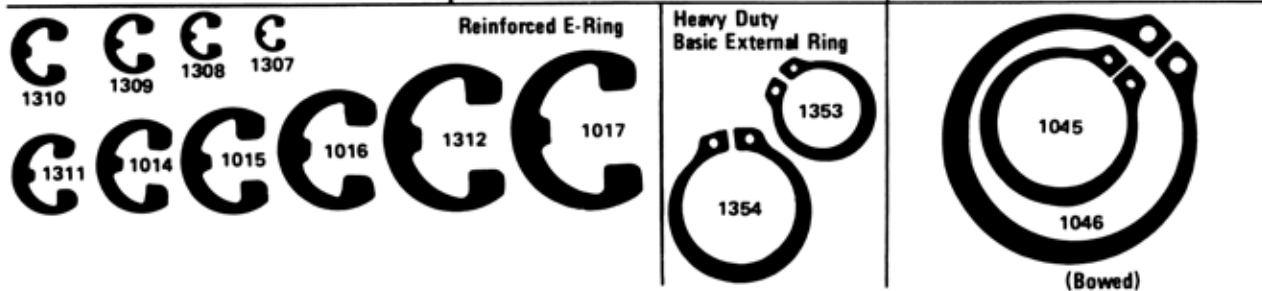
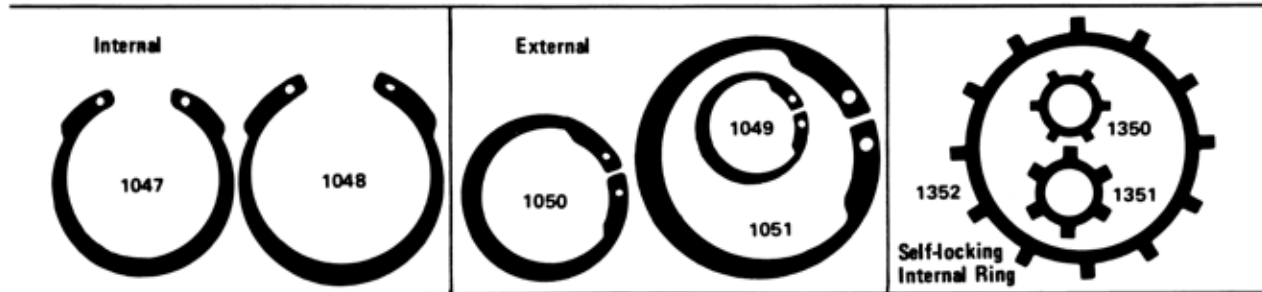
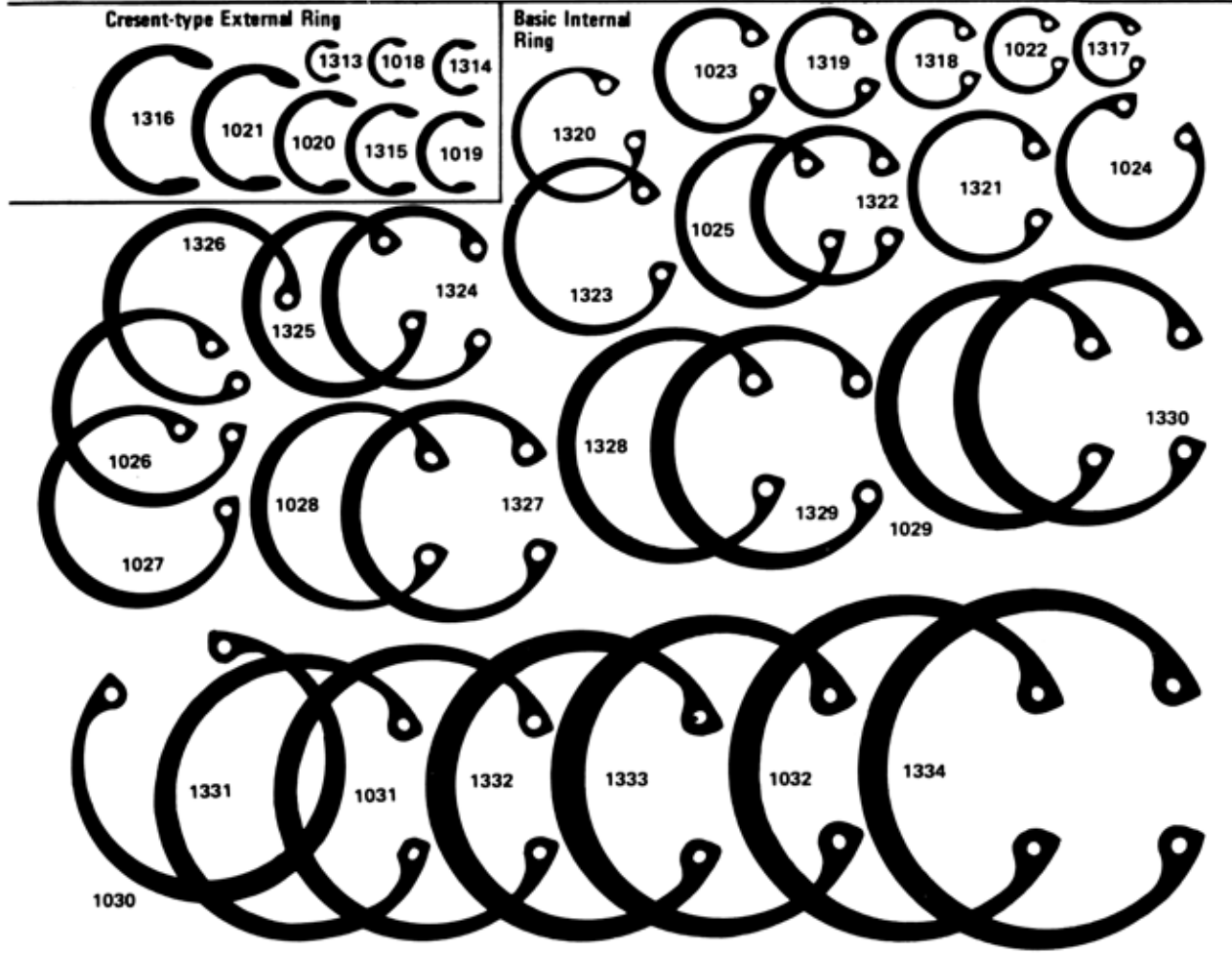
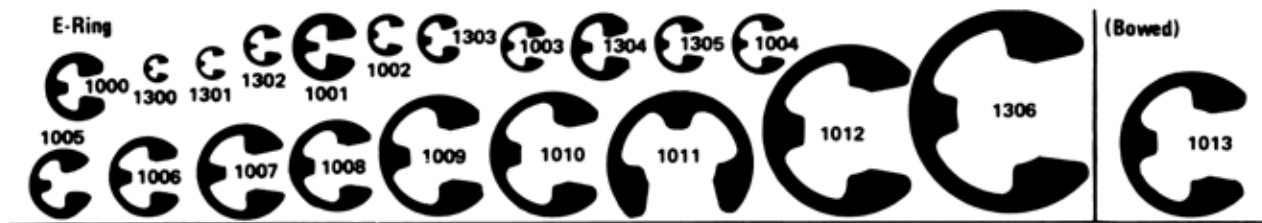

16 AUTO SPECIALTY

GEARWRENCH® Deluxe Feeler Gauge

- Gauge Measures Clearances From 0.0015 to 0.035" (0.038 to 0.889mm)
- Includes One 0.010" Brass Blade to Use with Electronic Ignitions
- Blade Lengths: 3-5/16" Long, Blade Width: 1/2"

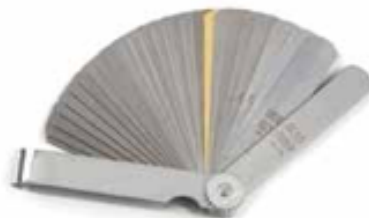

Cat. No.	UPC No.	Packaging	Feeler Gauge Sizes (inch)	Feeler Gauge Sizes (mm)	Product Weight
161D	082171001611	Carded	0.0015, 0.002, 0.0025, 0.003, 0.004, 0.005, 0.006, 0.007, 0.008, 0.009, 0.01, 0.01 (Brass), 0.011, 0.012, 0.013, 0.014, 0.015, 0.016, 0.017, 0.018, 0.019, 0.02, 0.021, 0.022, 0.023, 0.024, 0.025, 0.026, 0.028, 0.03, 0.032, 0.035	0.038, 0.051, 0.063, 0.076, 0.102, 0.127, 0.152, 0.178, 0.203, 0.229, 0.254, 0.254 (Brass), 0.279, 0.305, 0.33, 0.356, 0.381, 0.406, 0.432, 0.457, 0.483, 0.508, 0.533, 0.559, 0.584, 0.61, 0.635, 0.66, 0.711, 0.762, 0.813, 0.889	0.25 lb

GEARWRENCH® Feeler Gauge

- Gauge Measures Clearances 0.002 to 0.025" (0.051 to 0.635mm)
- 2-1/2" Rule and 15 Blades
- Blade Lengths: 3-5/16" Long



Cat. No.	UPC No.	Packaging	Feeler Gauge Sizes (inch)	Feeler Gauge Sizes (mm)	Product Weight
162D	082171001628	Carded	0.002, 0.003, 0.004, 0.005, 0.006, 0.008, 0.011, 0.012, 0.013, 0.014, 0.016, 0.018, 0.02, 0.022, 0.025	0.051, 0.076, 0.102, 0.127, 0.152, 0.203, 0.279, 0.305, 0.33, 0.356, 0.406, 0.457, 0.508, 0.599, 0.635	0.14 lb

GEARWRENCH® Metric Feeler Gauge

- 25-Blade Gauge Measures Clearances From 0.04 to 1mm
- Blade Lengths: 3" Long



Cat. No.	UPC No.	Packaging	Feeler Gauge Sizes (mm)	Product Weight
2274D	082171022746	Carded	0.04, 0.05, 0.06, 0.07, 0.08, 0.09, 0.10, 0.15, 0.20, 0.25, 0.30, 0.35, 0.40, 0.45, 0.50, 0.55, 0.60, 0.65, 0.70, 0.75, 0.80, 0.85, 0.90, 0.95, 1.00	0.22 lb

GEARWRENCH® Mini Feeler Gauge

- Miniature 16-Blade Feeler Gauges Are Only 1/4" Wide and Measure Clearances From 0.010 to 0.035" (0.254 to 0.889mm)
- Blade Lengths: 1-3/4" Long



Cat. No.	UPC No.	Packaging	Feeler Gauge Sizes (inch)	Feeler Gauge Sizes (mm)	Product Weight
2062D	082171020629	Carded	0.01, 0.012, 0.015, 0.016, 0.017, 0.018, 0.019, 0.02, 0.022, 0.024, 0.025, 0.026, 0.028, 0.03, 0.032, 0.035	0.254, 0.305, 0.381, 0.406, 0.432, 0.457, 0.483, 0.508, 0.559, 0.61, 0.635, 0.66, 0.711, 0.762, 0.813, 0.889	0.05 lb

GEARWRENCH® Valve-Tappet Feeler Gauge

- 11-Blade Gauge Measures Valve Tappet Clearances From 0.008" to 0.026"
- Offset Blades Provide Easy Access.
- Blade Lengths: 3-3/4" Long



Cat. No.	UPC No.	Packaging	Feeler Gauge Sizes (inch)	Feeler Gauge Sizes (mm)	Product Weight
163D	082171001635	Carded	0.008, 0.010, 0.012, 0.013, 0.014, 0.015, 0.016, 0.018, 0.019, 0.020, 0.026	0.203, 0.254, 0.305, 0.330, 0.356, 0.381, 0.406, 0.457, 0.483, 0.508, 0.660	0.16 lb

GEARWRENCH® Non-Magnetic Feeler Gauge

- 6-Blade Gauge Measures Clearance in Electronic Ignition Systems Where Non-Magnetic Blades are Required
- These Hard Brass Blades Will Not Magnetize
- Blade Lengths: 3-5/16" Long



Cat. No.	UPC No.	Packaging	Feeler Gauge Sizes (inch)	Feeler Gauge Sizes (mm)	Product Weight
2223D	082171022234	Carded	0.006, 0.008, 0.01, 0.012, 0.014, 0.016	0.152, 0.203, 0.254, 0.305, 0.356, 0.406	0.05 lb

GEARWRENCH® Spark Plug Gap and Feeler Gauge Set

- Use to Set and Measure Spark Plug Gaps Plus Other Ignition Clearances From 0.010 to 0.045" (0.254 to 1.143mm)
- Six Wire Gauges Check Spark Plug Gaps and 12 Straight Blades Check Other Clearances
- Includes a Double-Ended Electrode Tool for Easy Adjustments
- Blade Lengths: 3-5/16" Long



Cat. No.	UPC No.	Packaging	Feeler Gauge Sizes (inch)	Feeler Gauge Sizes (mm)	Product Weight
164	082171001642	Carded	0.025(Wire), 0.03(Wire), 0.034(Wire), 0.035(Wire), 0.04(Wire), 0.045(Wire), 0.01, 0.012, 0.015, 0.016, 0.017, 0.018, 0.019, 0.02, 0.022, 0.024, 0.025, 0.026	0.635(Wire), 0.762(Wire), 0.864(Wire), 0.889(Wire), 1.016(Wire), 1.143(Wire), 0.254, 0.305, 0.381, 0.406, 0.432, 0.457, 0.483, 0.508, 0.559, 0.61, 0.65, 0.66	0.19 lb

GEARWRENCH® Spark Plug Gap Wire Gauge

- Use Gauge to Measure Spark Plug Electrode Gaps From 0.025 to 0.045" (0.635 to 1.143mm)
- Includes 2 Electrode Adjusting Tools

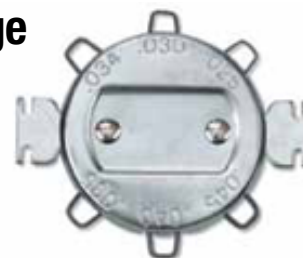

Cat. No.	UPC No.	Feeler Gauge Sizes (inch)	Feeler Gauge Sizes (mm)	Product Weight
166D	082171001666	0.025, 0.03, 0.034, 0.035, 0.04, 0.045	0.635, 0.762, 0.864, 0.889, 1.016, 1.143	0.08 lb

GEARWRENCH® Spark Plug Gap Gauge

- Circular Coin-Type Ramp Gauge Easily Measures Spark Plug Gaps From 0.020 to 0.100" (0.635 to 1.143mm)



Cat. No.	UPC No.	Product Weight
3293D	082171032936	0.05 lb

GEARWRENCH® Digital Brake Drum Gauge

- 3" to 16"
- Preset at 1-1/2" Depth with Indicators for 0.5" and 1"
- Manual Power On/Off
- Metric/Inch System Interchange at Any Position
- Zero Setting at Any Position
- Data Output Interface
- Measure Wear Dimension of the Brake Drum
- Resolution / Repeatability 0.0005" X 0.01mm
- Storage Case



Cat. No.	UPC No.	Packaging	Product Weight
3777	082171037771	Boxed	4.06 lb

GEARWRENCH® Digital Brake Rotor Gauge

- 0 to 6"
- Manual Power On/Off
- Metric/Inch System Interchange at Any Position
- Zero Setting at Any Position
- Data Output Interface
- Measure Wear Dimension of the Brake Rotors
- Resolution / Repeatability 0.0005" X 0.01mm
- Storage Case



Cat. No.	UPC No.	Packaging	Product Weight
3774D	082171037740	Boxed	1.01 lb

GEARWRENCH® 6" Digital Caliper with Large LCD window

- LCD Displays Up to 5 Digits
- Glass Window Over LCD is Clearer and Does Not Wear Out
- Color Coded Off, On/Zero and Inch/mm
- Stainless Steel Frame with Hardened Jaws, Graduated
- Scale and Thumb Roll
- 4 Way Measurement, Inside, Outside, Depth & Step
- Resolution / Repeatability 0.001" X 0.01mm
- Data Output Interface
- Fitted in a Plastic Box



Cat. No.	UPC No.	Packaging	Product Weight
3756D	082171037566	Boxed	0.76 lb

GEARWRENCH® Electronic Digital Rotor Micrometer

- Manual Power On/Off
- 0-1.3", (0-76mm) Grad. 0.001"
- 3-1/2" Deep Throat
- Metric/Inch System Interchange at Any Position
- Zero Setting at Any Position
- With Data Output Interface
- Measures Thickness of Inside Grooves
- Fitted in a Plastic Box



Cat. No.	UPC No.	Packaging	Product Weight
3763	082171037634	Boxed	3.72 lb

GEARWRENCH® Dial Indicator Set with On/Off Stand

- English Dial Gauge Range: 0-1.3", Gradations: 0.001"
- Centered V-Magnet for Strongest Grip on Round or Flat Surfaces
- Powerful 130 Lbs. Pull
- Two Magnetic Mounting Surfaces: Bottom and Back
- Swivel Adapter to Mount All Agd Dial Indicators with Lug Backs
- Universal Dovetail Clamp for Dial Test Indicators
- On / Off Switch
- Center Rod 1/2" Diameter X 7" High



Cat. No.	UPC No.	Packaging	Product Weight
3761	082171037610	Boxed	4.64 lb

GEARWRENCH® Dial Indicator

- 2-1/4" Face
- 3/8" Diameter Shank
- English Dial Gauge Range: 0-1.3"
- Graduations: 0.001"



Cat. No.	UPC No.	Packaging	Product Weight
3766	082171037665	Boxed	0.46 lb

GEARWRENCH® Pocket Slide Caliper

- 4" Stainless Steel
- One Side - 32nd Inch, One Side - 1mm.



Cat. No.	UPC No.	Packaging	Product Weight
2527D	082171025273	Boxed	0.15 lb

GEARWRENCH® 6" Pocket Stainless Steel Rule

- Stainless Steel Flexible Blade
- One Side - 32nd Inch, One Side - 1mm



Cat. No.	UPC No.	Packaging	Product Weight
2522D	082171025228	Boxed	0.05 lb

GEARWRENCH® Angle Finder

- Use Finder to Measure Angles of Most Parts Such As Frame Angle (Pitch Forward or Backward) for Setting Truck Front Ends.
- A Magnet in the Base Holds Tool in Place. It is Graduated in 1/2° Increments.



Cat. No.	UPC No.	Packaging	Product Weight
2968D	082171029684	Boxed	0.80 lb

GEARWRENCH® Hand-Held Tachometer

- Tachometer Checks Diesels, Pumps, Compressors, Power Take-Offs and Farm and Construction Equipment Revolution Speed
- Tool is Ideal Where Electric Tachometer Cannot Be Used
- To Use, Hold Rubber Tip Against End of Rotating Shaft and Read Revolutions Per Minute Directly From Dial
- Range is 100 to 4000 RPM (Clockwise or Counterclockwise)
- Length: 4-1/4"
- Diameter: 2-3/4"



Cat. No.	UPC No.	Packaging	Description	Product Weight
2967	082171029677	Carded	Hand-Held Tachometer	0.75 lb

GEARWRENCH® Mechanic's Stethoscope

- Stethoscope Locates the Source of Engine Noise Quickly
- Listen for Trouble By Tracing the Sound of Flowing Water, Oil, Gas or Steam
- Identify Piston Slap, Worn Gears, Faulty Valves, Water Pump Failure, Damaged Gaskets and Defective Bearings
- Stethoscope Has a Shock-Resistant Handle and Disassembles for Storage



Cat. No.	UPC No.	Packaging	Description	Product Weight
835D	082171008351	Carded	Mechanic's Stethoscope	0.25 lb

GEARWRENCH® Telescoping Inspection Mirrors

- Perfect for Inspecting Hidden Areas.
- Mirror Swivels to Almost Any Position



Cat. No.	UPC No.	Packaging	Mirror Shape	Mirror Size	Overall Length Min	Overall Length Max	Product Weight
2840D	082171028403	Carded	Round	1-1/4 in	4.75 in	17 in	0.10 lb
84085	099575840852	Carded	Rectangular	2.125 in x 3.5 in	6.5 in	29.75 in	0.25 lb
84086	099575840869	Carded	Round	2-1/4 in	6.5 in	36.375 in	0.16 lb

GEARWRENCH® Lighted Telescoping Inspection Mirror

- Perfect for Inspecting Hidden Areas
- LED Light Illuminates Low Light Areas
- Mirror Swivels to Almost Any Position
- Heavy Duty Dual Material Non-Slip Grip
- Batteries included



Cat. No.	UPC No.	Packaging	Mirror Shape	Mirror Size	Overall Length Min	Overall Length Max
84087	099575840876	Carded	Round	2.375 in	6.5 in	36.75 in

GEARWRENCH® 18" Magnetic Pickup Tool

- Retrieve small, ferrous metal parts easily.
- Nickel-plated tool has a powerful, permanent magnet (and an easy-grip knurled handle).
- Shaft flexes to go around corners.
- Magnet diameter: 1/2 in.



Cat. No.	UPC No.	Length	Product Weight
1711D	082171017117	18.0 in	0.25 lb

GEARWRENCH® Telescoping Magnetic Pickup Tool

- Pick Up Hard-To-Reach Ferrous Metal Parts or Tools
- Includes Pocket Clip



Cat. No.	UPC No.	Packaging	Overall Length Min	Overall Length Max	Product Weight
2593	082171025938	Carded	5.5 in	25.56 in	0.08 lb
84088	099575840883	Carded	7.5 in	33.25 in	0.1 lb
84089	099575840890	Carded	7.5 in	33.25 in	0.12 lb

GEARWRENCH® 23" Flexible Retrieving Tool

- Retrieve Small Objects From Hard-To-Reach Places
- Push the Button to Open the Claws and Release to Grab



Cat. No.	UPC No.	Packaging	Product Weight
2391	082171023910	Carded	0.23 lb

GEARWRENCH® 2-Ton and 5-Ton Ratcheting Puller Set

- Ratcheting Pullers Have a Time-Saving, Indexing-Jaw Design
- Legs Index Into Position and Stay in Place, Letting You Easily Support the Puller and Quickly Connect Each Jaw One at a Time to the Pulley—Without Help
- Pullers Can Also Be Converted to Two- and Three-Leg Pullers and the Jaws Reversed From External to Internal Style in Seconds



Cat. No.	UPC No.	Packaging	Product Weight
3627	082171036279	Boxed	5.13 lb

Cat. No.	Description	Cat. No.	Description
3624D	2 Ton Ratcheting Puller	3625	5 Ton Ratcheting Puller

GEARWRENCH® 2-Ton Ratcheting Puller

- Ratcheting Pullers Have a Time-Saving, Indexing-Jaw Design
- Legs Index Into Position and Stay in Place, Letting You Easily Support the Puller and Quickly Connect Each Jaw One at a Time to the Pulley—Without Help
- Pullers Can Also Be Converted to Two- and Three-Leg Pullers and the Jaws Reversed From External to Internal Style in Seconds



Cat. No.	UPC No.	Packaging	Ton	Reach/Length	Jaw Capacity	Screw Size	Screw Length	Jaw Thickness	Jaw Width	Product Weight
3624D	082171362408	Boxed	2 t	2-5/8 in	3-1/4 in	3/8 in - 24	4-1/2 in	3/8 in	5/8 in	2.55 lb

Cat. No.	Description	Cat. No.	Description
362401	3 Pc. Legs Replacement Set	362403	Screw Replacement
362402	Yoke Replacement		

GEARWRENCH® 5-Ton Ratcheting Puller

- Ratcheting Pullers Have a Time-Saving, Indexing-Jaw Design
- Legs Index Into Position and Stay in Place, Letting You Easily Support the Puller and Quickly Connect Each Jaw One at a Time to the Pulley—Without Help
- Pullers Can Also Be Converted to Two- and Three-Leg Pullers and the Jaws Reversed From External to Internal Style in Seconds



Cat. No.	UPC No.	Packaging	Ton	Reach/Length	Jaw Capacity	Screw Size	Screw Length	Jaw Thickness	Jaw Width	Product Weight
3625	082171362507	Boxed	5 t	4 in	5 in	9/16 in - 12	8-1/4 in	9/16 in	11/16 in	3.31 lb

Cat. No.	Description	Cat. No.	Description
362501	3 Pc. Legs Replacement Set	362503	Screw Replacement
362502	Yoke Replacement		

GEARWRENCH® 5-Ton Ratcheting Short / Long Leg Puller

- Ratcheting Pullers Have a Time-Saving, Indexing-Jaw Design
- Legs Index Into Position and Stay in Place, Letting You Easily Support the Puller and Quickly Connect Each Jaw One at a Time to the Pulley—Without Help
- Pullers Can Also Be Converted to Two- and Three-Leg Pullers and the Jaws Reversed From External to Internal Style in Seconds
- For Short Leg Specifications see 3625, Table below Shows Long Leg Specifications



Cat. No.	Description	Cat. No.	Description
362502	Yoke Replacement	362801	3 Pc. Long Legs Replacement Set
362503	Screw Replacement		

Cat. No.	UPC No.	Packaging	Ton	Reach/Length	Jaw Capacity	Screw Size	Screw Length	Jaw Thickness	Jaw Width	Product Weight
3628D	082171036286	Boxed	5 t	6-3/4 in	7-1/2 in	9/16 in - 12	8-1/4 in	9/16 in	11/16 in	6.22 lb

GEARWRENCH® 7-Ton Ratcheting Puller

- Ratcheting Pullers Have a Time-Saving, Indexing-Jaw Design
- Legs Index Into Position and Stay in Place, Letting You Easily Support the Puller and Quickly Connect Each Jaw One at a Time to the Pulley—Without Help
- Pullers Can Also Be Converted to Two- and Three-Leg Pullers and the Jaws Reversed From External to Internal Style in Seconds
- Maximum Spread of 10 Inches



Cat. No.	Description	Cat. No.	Description
362601	3 Pc. Legs Replacement Set	362603	Screw Replacement
362602	Yoke Replacement		

Cat. No.	UPC No.	Packaging	Ton	Reach/Length	Jaw Capacity	Screw Size	Screw Length	Jaw Thickness	Jaw Width	Product Weight
3626	082171036262	Boxed	7 t	6-3/4 in	10 in	3/4 in - 12	12 in	9/16 in	11/16 in	6.80 lb

GEARWRENCH® Combination 2 Jaw Reversible (Internal/External)

- Reversible Jaws for Internal and External Applications



Cat. No.	UPC No.	Packaging	Ton	Reach/Length	Jaw Capacity	Screw Size	Screw Length	Upper Jaw Thickness	Lower Jaw Thickness	Upper Jaw Width	Lower Jaw Width	Product Weight
3551D	082171035517	Carded	2 t	3-1/2 in	5 in	3/8 in - 24	4-7/8 in	3/16 in	1/8 in	5/16 in	1/2 in	1.02 lb
3552	082171035524	Carded	5 t	5-3/4 in	8 in	9/16 in - 20	7 in	1/4 in	5/16 in	3/8 in	3/4 in	2.52 lb
3553D	082171035531	Carded	7 t	5 in	9 in	11/16 in - 18	7-1/2 in	3/8 in	3/8 in	1 in	1 in	4.52 lb

GEARWRENCH® Combination 2 & 3 Jaw Reversible (Internal/External) Pullers

- Reversible Jaws for Internal and External Applications
- Includes Blow Mold Case for Storage



Cat. No.	UPC No.	Packaging	Ton	Reach/Length	Jaw Capacity	Screw Size	Screw Length	Upper Jaw Thickness	Lower Jaw Thickness	Upper Jaw Width	Lower Jaw Width	Product Weight
3561	082171035616	Carded	2 t	3-1/2 in	5.0 in	3/8 in - 24	4-7/8 in	3/16 in	1/8 in	5/16 in	1/2 in	1.30 lb
3562D	082171035623	Carded	5 t	5-3/4 in	8.0 in	9/16 in - 20	7 in	3/8 in	3/4 in	3/8 in	3/4 in	2.50 lb
3563	082171035630	Carded	7 t	5 in	9.0 in	11/16 in - 18	7-1/2 in	3/8 in	3/8 in	1 in	1 in	6.05 lb

GEARWRENCH® 10 Way Slide Hammer Puller Set

- Provides a Wide Range of Puller Applications Such as: Flange Type Axles, Oil Seals & Other Press Fit Parts
- Jaws Can Be Set Up for 2 or 3 Jaw Internal or External Pulling Jobs
- Includes Blow Mold Case for Storage



Cat. No.	UPC No.	Packaging	Product Weight
41700D	082171041709	Boxed	17.0 lb

Cat. No.	Description	Cat. No.	Description	Cat. No.	Description
3591D	5-1/2 lb. Slide Hammer Only	41706	Center Bolt & Cone	230071D	Shallow Flange
41704	2 Way Yoke	41707	3 Pc. Adapter Set	230075D	Deep Flange
41705	3 Way Yoke	41708	Leg Package & Screws		

GEARWRENCH® Rear Axle Bearing Puller Set

- Three Pullers Designed to Make the Removal of Semi-Floating Rear Axle Bearings Easier
- 1" X 1-7/8" Puller
- 1-5/16" X 2-3/8" Puller
- 1-3/8" X 2-7/8" Puller



Cat. No.	UPC No.	Packaging	Description	Product Weight
41710	082171417108	Boxed	Rear Axle Bearing Puller Set	3.3 lb

GEARWRENCH® 24" Basic Slide Hammer Unit

- 5 lb Hammer with a 5/8" - 18 Threaded End
- May Be Used With an Internal Pulling Attachment With Female or Male Female Threaded Adapters



Cat. No.	UPC No.	Packaging	Product Weight
3591D	082171035913	Carded	7.05 lb

GEARWRENCH® Split Bearing Attachments

- Attachments are Used for the Removal of Bearings, Thin-Faced and Cone-Shaped Gears
- Beveled Edge Allows Insertion Behind Pulleys, Gears or Bearings Where Space Limits the Use of a Standard Puller Jaw
- Grip the Part to be Pulled, then Pull with a Gear Puller

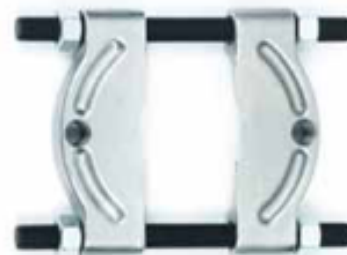

Cat. No.	UPC No.	Packaging	Spread (Min, Max)	Width	Screw Size	Product Weight
83600	099575836008	Carded	1/8 in, 2 in	2-7/16 in	3/8 in - 16	1.30 lb
83601	099575836015	Carded	1/2 in, 4-5/8 in	4-3/8 in	5/8 in - 18	5.90 lb
83602	099575836022	Carded	1/2 in, 9 in	6 in	5/8 in - 18	12.70 lb

GEARWRENCH® Fender Cover, Magnetic

- Magnetic
- Oil Resistant
- 34-1/2" Wide
- 18-1/2" Tall



Cat. No.	UPC No.	Packaging	Description	Product Weight
86991	099575869914	Boxed	Magnetic Fender Cover	1.53 lb

GEARWRENCH® Mechanics Gloves



Cat. No.	UPC No.	Packaging	Description	Product Weight
86990	099575869907	Retail Packaging	Mechanics Gloves	0.20 lb

GEARWRENCH® Aluminum Flashlight

- Aluminum Body with Rubber Grip
- Five LED Bulbs Above 13,000 MCD White Light
- Weatherproof
- Rubber Ring Around Head of Flashlight
- Includes Carrying Case



Cat. No.	UPC No.	Packaging	Description	Product Weight
83132	099575831324	Retail Packaging	LED Flashlight with Carry Case	0.25 lb

GEARWRENCH® O-Ring and Seal Pick

- Remove and Install O-Rings and Small Oil Seals
- Hardened Tip Keeps a Sharp Point
- Tool is Ideal for Transmission, Power Steering Pump, Disc Brake and Air Conditioning Repairs

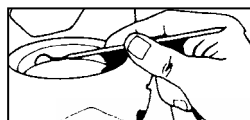

Cat. No.	UPC No.	Packaging	Description	Product Weight
2554D	082171025549	Carded	O-Ring and Seal Pick	0.04 lb



GEARWRENCH® 5 Pc. Hook and Pick Set

- Five-Piece Set Includes a 5" Aluminum Handle Knurled for a Sure Grip
- Includes the Following Heat-Treated, High Carbon Steel Picks: O-Ring, 90°, Straight and Hook
- Use Picks to Pull O-Rings, Seals, Cotter Pins and Brushes Quickly and Easily



Cat. No.	UPC No.	Packaging	Description	Product Weight
3121D	082171031212	Boxed	Hook and Pick Set	1.10 lb

GEARWRENCH® Vibro Engraver

- Use to Identify Valuables Permanently
- Carbide Tip Engraves Metal, Plastic, Wood, Glass and Other Surfaces
- Variable Speed Knob Controls the Depth of Engraving
- Tool Operates on 115V AC



Cat. No.	UPC No.	Packaging	Description	Product Weight
2520	082171025204	Carded	Vibro Engraver	0.70 lb

GEARWRENCH® Scriber

- Sharp, Tempered Point Scribes Metal
- Hooked End Removes O-Rings, Seals and Gaskets
- Has a 90° Hook
- Length: 8"



Cat. No.	UPC No.	Packaging	Description	Product Weight
2979	082171029790	Carded	Scriber	0.15 lb

GEARWRENCH® Universal Nut Cracker

- Splits Most Stubborn Nuts 7/16" (11mm) Through 3/4" (19mm) Across the Flats
- Works in Channels Not Accessible to Other Tools
- Parallel Action of Pusher Cracks Nuts Without Damaging Bolt Threads
- Chisel Rotates 360° to Line Up Parallel to Bolt
- Simply Tighten the Screw Until the Nut Splits Has Rugged Drop-Forged Frame
- Do Not Use on Heat-Treated Nuts
- Length: 6-3/4"
- This is a Serviceable Product



Cat. No.	UPC No.	Packaging	Description	Product Weight
715D	082171007156	Carded	Universal Nut Cracker	1.50 lb
71575D	082171715754	Bagged	Replacement Plunger	0.05 lb
71574	082171715747	Bagged	Replacement Chisel	0.25 lb
71573D	082171715730	Bagged	Replacement Ball Bearings	0.01 lb

GEARWRENCH® 6 Pc. 3/8" Drive Impact Driver Set

- Free Frozen Bolts and Screws by Twisting the Tool in the Direction of the Rotation and Holding while Striking with a Hammer
- Reverse Action to Tighten Bolts
- Set is Standard 3/8" Square Drive and includes a 3/8" Square Drive Adapter for 5/16" Hex Bits
- Four-bit Set includes No. 2 and No. 3 Phillips Bits and 5/16" and 9/32" Slotted Bits

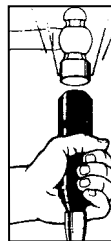

Cat. No.	UPC No.	Packaging	Description	Product Weight
1140D	082171011405	Carded	6 Pc. 3/8" Drive Impact Driver Set	1.53 lb
412402	082171412424	Bagged	No. 2 Phillips Insert Bit 5/16" Dr.	0.05 lb
412403	082171412400	Bagged	Replacement No. 3 Phillips Insert Bit 5/16" Dr.	0.01 lb
412406	082171412462	Bagged	Replacement 6-8 Slotted Insert Bit 5/16" Dr.	0.01 lb
412410	082171412417	Bagged	Replacement 8-10 Slotted Insert Bit 5/16" Dr.	0.01 lb



Hex Key Foldups	485
Short Arm Hex Keys.....	486
Long Arm Hex Keys.....	487
Ball-Plus™ Hex Keys	488
Ball-Plus™ Cushion Grip T-Handles	489

ALLEN Hex Keys

William G. Allen patented a cold drawing process for making hex socket set screws that were stronger than any other at the time. These quality fasteners demanded quality tools so it wasn't long before the Allen hex key wrench was created. As the business grew so did Allen's reputation for uncompromising quality. Today the makers of the number one hex key wrench in the world have put nearly a century of experience into a hex wrench product line with the quality durability and value worthy of the name Allen.

All Allen hex keys are manufactured with heat-treated alloy steel, black finish to precision tolerances, and meet the requirements of ASME/ANSI B18.3 and Federal Standard GGG-K-275 AMED 1.

Longer length keys for additional leverage and extended reach

All hex keys are precision formed to exact dimensional tolerances for precise fit

Rotates to 270 degrees to a firm stop for better torqueing and access

Dual material case is color coded for quick identification: SAE - Green, Metric - Blue

Heat treated, tempered alloy steel provides high strength and resistance to rotational distortion

Dual Material T-Handle provides superior strength and ultimate comfort for extra torque and safety

T-Thru handle design has a long arm with ball end for access and a standard hex short arm for high torque

Non-interference hinged caddy provides easy access to each key

Color coded for quick identification: SAE - Green, Metric - Blue

Ball-Plus™ hex permits an entry angle up to 25° to work in hard-to-reach areas



Hex, Ball and Torx® make up the most complete line of key configurations available

ALLEN 9-Key SAE Hex Key Fold-up Set

- From Allen®, the Original Manufacturer of the Hex Key
- Heat Treated, Tempered Alloy Steel Provides High Strength and Resistance to Rotational Distortion
- All Hex Keys Are Precision Formed to Exact Dimensional Tolerances for Precise Fit
- Rotates to 270 Degrees to A Firm Stop for Better Torqueing and Access
- Dual Material Case is Color Coded for Quick Identification: SAE - Green



Cat. No.	UPC No.	Packaging	Number of Keys	Key Sizes	Handle Length	Product Weight
56622G	082171566226	Carded	9	0.050, 1/16, 5/64, 3/32, 7/64, 1/8, 9/64, 5/32, 3/16	4-1/4 in	0.22 lb
56624G	082171566240	Carded	9	5/64, 3/32, 7/64, 1/8, 9/64, 5/32, 3/16, 7/32, 1/4	4-1/4 in	0.22 lb

ALLEN 8-Key Torx® Key Fold-up Set

- From Allen®, the Original Manufacturer of the Hex Key
- Heat Treated, Tempered Alloy Steel Provides High Strength and Resistance to Rotational Distortion
- All Hex Keys Are Precision Formed to Exact Dimensional Tolerances for Precise Fit
- Rotates to 270 Degrees to A Firm Stop for Better Torqueing and Access
- Dual Material Case is Color Coded for Quick Identification: Black - Torx®



Cat. No.	UPC No.	Packaging	Number of Keys	Key Sizes	Handle Length	Product Weight
56634G	082171566349	Carded	8	T-8, T-10, T-15, T-20, T-25, T-27, T-30, T-40	4-1/4 in	0.34 lb

ALLEN 7-Key Metric Hex Key Fold-up Set

- From Allen®, the Original Manufacturer of the Hex Key
- Heat Treated, Tempered Alloy Steel Provides High Strength and Resistance to Rotational Distortion
- All Hex Keys Are Precision Formed to Exact Dimensional Tolerances for Precise Fit
- Rotates to 270 Degrees to A Firm Stop for Better Torqueing and Access
- Dual Material Case is Color Coded for Quick Identification: Metric Blue



Cat. No.	UPC No.	Packaging	Number of Keys	Key Sizes	Handle Length	Product Weight
56626G	082171566264	Carded	7	1.5, 2, 2.5, 3, 4, 5, 6	4-1/4 in	0.25 lb

ALLEN 13-Key SAE Short Arm Hex Key Set

- Made in the USA - Quality and Availability
- From Allen®, the Original Manufacturer of the Hex Key
- Heat Treated, Tempered Alloy Steel Provides High Strength and Resistance to Rotational Distortion
- All Hex Keys Are Precision Formed to Exact Dimensional Tolerances for Precise Fit
- Color Coded Key Caddy Organizes and Stores Hex Keys



Cat. No.	UPC No.	Packaging	Number of Keys	Key Sizes	Product Weight
56080	082171560804	Bulk	13	0.050, 1/16, 5/64, 3/32, 7/64, 1/8, 9/64, 5/32, 3/16, 7/32, 1/4, 5/16, 3/8	0.52 lb

Cat. No.	Description	Cat. No.	Description	Cat. No.	Description
57006	0.050" Short Arm L Hex Key	57014D	1/8" Short Arm L Hex Key	57026D	1/4" Short Arm L Hex Key
57008D	1/16" Short Arm L Hex Key	57018	9/64" Short Arm L Hex Key	57028	5/16" Short Arm L Hex Key
57010	5/64" Short Arm L Hex Key	57020D	5/32" Short Arm L Hex Key	57030D	3/8" Short Arm L Hex Key
57012	3/32" Short Arm L Hex Key	57022	3/16" Short Arm L Hex Key		
57013D	7/64" Short Arm L Hex Key	57024	7/32" Short Arm L Hex Key		

ALLEN 9-Key Metric Short Arm Hex Key Set

- Made in the USA - Quality and Availability
- From Allen®, the Original Manufacturer of the Hex Key
- Heat Treated, Tempered Alloy Steel Provides High Strength and Resistance to Rotational Distortion
- All Hex Keys Are Precision Formed to Exact Dimensional Tolerances for Precise Fit
- Metal Box or Pouch Conveniently Organizes and Stores Hex Keys



Cat. No.	UPC No.	Packaging	Number of Keys	Key Sizes	Product Weight
56008D	082171560088	Bulk	9	1.5, 2, 2.5, 3, 4, 5, 6, 8, 10	0.49 lb
56015D	082171560156	Pouch	9	1.5, 2, 2.5, 3, 4, 5, 6, 8, 10	0.49 lb

Cat. No.	Description	Cat. No.	Description	Cat. No.	Description
57116	1.5mm Short Arm L Hex Key	57122	3mm Short Arm L Hex Key	57128	6mm Short Arm L Hex Key
57118	2mm Short Arm L Hex Key	57124	4mm Short Arm L Hex Key	57130	8mm Short Arm L Hex Key
57120	2.5mm Short Arm L Hex Key	57126	5mm Short Arm L Hex Key	57132	10mm Short Arm L Hex Key

ALLEN 22-Key SAE/Metric Long Arm Hex Key Set

- From Allen®, the Original Manufacturer of the Hex Key
- Heat Treated, Tempered Alloy Steel Provides High Strength and Resistance to Rotational Distortion
- All Hex Keys Are Precision Formed to Exact Dimensional Tolerances for Precise Fit
- Longer Length Keys for Additional Leverage and Extended Reach
- Non-Interference Hinged Caddy Provides Easy Access to Each Key



Cat. No.	UPC No.	Packaging	Number of Keys	Key Sizes	Product Weight
56609G	082171566097	Carded	22	INCH 0.050, 1/16, 5/64, 3/32, 7/64, 1/8, 9/64, 5/32, 3/16, 7/32, 1/4, 5/16, 3/8; MM 1.5, 2, 2.5, 3, 4, 5, 6, 8, 10	0.73 lb

ALLEN 13-Key SAE Long Arm Hex Key Set

- From Allen®, the Original Manufacturer of the Hex Key
- Heat Treated, Tempered Alloy Steel Provides High Strength and Resistance to Rotational Distortion
- All Hex Keys Are Precision Formed to Exact Dimensional Tolerances for Precise Fit
- Longer Length Keys for Additional Leverage and Extended Reach
- Non-Interference Hinged Caddy Provides Easy Access to Each Key



Cat. No.	UPC No.	Packaging	Number of Keys	Key Sizes	Product Weight
56603G	082171566035	Carded	13	0.050, 1/16, 5/64, 3/32, 7/64, 1/8, 9/64, 5/32, 3/16, 7/32, 1/4, 5/16, 3/8	0.92 lb

ALLEN 9-Key Metric Long Arm Hex Key Set

- From Allen®, the Original Manufacturer of the Hex Key
- Heat Treated, Tempered Alloy Steel Provides High Strength and Resistance to Rotational Distortion
- All Hex Keys Are Precision Formed to Exact Dimensional Tolerances for Precise Fit
- Longer Length Keys for Additional Leverage and Extended Reach
- Non-Interference Hinged Caddy Provides Easy Access to Each Key



Cat. No.	UPC No.	Packaging	Number of Keys	Key Sizes	Product Weight
56606G	082171566066	Carded	9	1.5, 2, 2.5, 3, 4, 5, 6, 8, 10	0.80 lb

ALLEN 22-Key SAE/Metric Ball-Plus™ Hex Key Set

- From Allen®, the Original Manufacturer of the Hex Key
- Ball-Plus™ Hex Keys Permit An Entry Angle Up to 25° to Work in Hard-To-Reach Areas
- Heat Treated, Tempered Alloy Steel Provides High Strength and Resistance to Rotational Distortion
- All Hex Keys Are Precision Formed to Exact Dimensional Tolerances for Precise Fit
- Longer Length Keys for Additional Leverage and Extended Reach
- Non-Interference Hinged Caddy Provides Easy Access to Each Key



Cat. No.	UPC No.	Packaging	Number of Keys	Key Sizes	Product Weight
56618G	082171566189	Carded	22	INCH 0.050, 1/16, 5/64, 3/32, 7/64, 1/8, 9/64, 5/32, 3/16, 7/32, 1/4, 5/16, 3/8; MM 1.5, 2, 2.5, 3, 4, 5, 6, 8, 10	1.69 lb

ALLEN 13-Key SAE Ball-Plus™ Hex Key Set

- From Allen®, the Original Manufacturer of the Hex Key
- Ball-Plus™ Hex Keys Permit An Entry Angle Up to 25° to Work in Hard-To-Reach Areas
- Heat Treated, Tempered Alloy Steel Provides High Strength and Resistance to Rotational Distortion
- All Hex Keys Are Precision Formed to Exact Dimensional Tolerances for Precise Fit
- Longer Length Keys for Additional Leverage and Extended Reach
- Non-Interference Hinged Caddy Provides Easy Access to Each Key



Cat. No.	UPC No.	Packaging	Number of Keys	Key Sizes	Product Weight
56612G	082171566127	Carded	13	0.050, 1/16, 5/64, 3/32, 7/64, 1/8, 9/64, 5/32, 3/16, 7/32, 1/4, 5/16, 3/8	0.91 lb

ALLEN 9-Key Metric Ball-Plus™ Hex Key Set

- From Allen®, the Original Manufacturer of the Hex Key
- Ball-Plus™ Hex Keys Permit An Entry Angle Up to 25° to Work in Hard-To-Reach Areas
- Heat Treated, Tempered Alloy Steel Provides High Strength and Resistance to Rotational Distortion
- All Hex Keys Are Precision Formed to Exact Dimensional Tolerances for Precise Fit
- Longer Length Keys for Additional Leverage and Extended Reach
- Non-Interference Hinged Caddy Provides Easy Access to Each Key



Cat. No.	UPC No.	Packaging	Number of Keys	Key Sizes	Product Weight
56615G	082171566158	Carded	9	1.5, 2, 2.5, 3, 4, 5, 6, 8, 10	0.81 lb

ALLEN 10 Pc. SAE Ball-Plus™ T-Thru Handle Set

- From Allen®, the Original Manufacturer of the Hex Key
- Dual Material T-Handle Provides Superior Strength and Ultimate Comfort for Extra Torque and Safety
- T-Thru Handle Design Has A Long Arm with Ball End for Access and A Standard Hex Short Arm for High Torque
- Ball-Plus™ Hex Permits An Entry Angle Up to 25° to Work in Hard-To-Reach Areas
- Heat Treated, Tempered Alloy Steel Provides High Strength and Resistance to Rotational Distortion
- All Hex Keys Are Precision Formed to Exact Dimensional Tolerances for Precise Fit
- Color Coded for Quick Identification: SAE - Green



Cat. No.	UPC No.	Packaging	Key Sizes	Product Weight
56656G	082171566561	Boxed	3/32, 7/64, 1/8, 9/64, 5/32, 3/16, 7/32, 1/4, 5/16, 3/8	2.96 lb

ALLEN 8 Pc. Metric Ball-Plus™ T-Thru Handle Set

- From Allen®, the Original Manufacturer of the Hex Key
- Dual Material T-Handle Provides Superior Strength and Ultimate Comfort for Extra Torque and Safety
- T-Thru Handle Design Has A Long Arm with Ball End for Access and A Standard Hex Short Arm for High Torque
- Ball-Plus™ Hex Permits An Entry Angle Up to 25° to Work in Hard-To-Reach Areas
- Heat Treated, Tempered Alloy Steel Provides High Strength and Resistance to Rotational Distortion
- All Hex Keys Are Precision Formed to Exact Dimensional Tolerances for Precise Fit
- Color Coded for Quick Identification: Metric Blue



Cat. No.	UPC No.	Packaging	Key Sizes	Product Weight
56660G	082171566608	Boxed	2, 2.5, 3, 4, 5, 6, 8, 10	2.74 lb

ALLEN 8 Pc. SAE Dual Material T-Handle Set

- From Allen®, the Original Manufacturer of the Hex Key
- Dual Material T-Handle Provides Superior Strength and Ultimate Comfort for Extra Torque and Safety
- Heat Treated, Tempered Alloy Steel Provides High Strength and Resistance to Rotational Distortion
- All Hex Keys Are Precision Formed to Exact Dimensional Tolerances for Precise Fit
- Color Coded for Quick Identification: SAE - Green, Metric Blue



Cat. No.	UPC No.	Packaging	Key Sizes	Product Weight
56650G	082171566509	Boxed	3/32, 7/64, 1/8, 9/64, 5/32, 3/16, 7/32, 1/4	1.05 lb

8 Pc. Metric Dual Material T-Handle Set

- From Allen®, the Original Manufacturer of the Hex Key
- Dual Material T-Handle Provides Superior Strength and Ultimate Comfort for Extra Torque and Safety
- Heat Treated, Tempered Alloy Steel Provides High Strength and Resistance to Rotational Distortion
- All Hex Keys Are Precision Formed to Exact Dimensional Tolerances for Precise Fit
- Color Coded for Quick Identification: SAE - Green, Metric Blue



Cat. No.	UPC No.	Packaging	Key Sizes	Product Weight
56652G	082171566523	Boxed	2, 2.5, 3, 4, 5, 6, 8, 10	1.67 lb



Jacobs
CHUCK

Keyless Chucks.....	493
Keyed Chucks	493
Keys & Accessories	494

Jacobs® Chucks

CHUCK

Jacobs® chucks, high precision tool holders, arbors, and related accessories have made Jacobs the leading brand of precision tool holding and work holding devices in the world. For more than 100 years, superior grip and accuracy have made Jacobs the industry leader, with Jacobs technology applied to everything from sophisticated CNC machining centers to cordless portable drills. Our commitment to excellence and innovation and continued investment in research and development provide us with the ability to maintain this leadership position.

HAND-TITE® KEYLESS CHUCKS

Split Bite Jaw increases grip over standard bite chucks by providing more contact with the bit

Precision Operation meets or exceeds stringent DIN run-out and dimensional specifications

Material and surface finish combinations result in increased comfort and performance

Anti-lock Nut prevents chuck from locking open

Hammerlock® positive locking mechanism prevents loosening in hammer and other high vibration applications

Provides high mechanical advantage to convert hand tightening torque into superior bit gripping force

Constructed of high performance material to maximize durability and performance

MULTI-CRAFT KEYED CHUCKS

Through-hardened jaws for hard, wear-resistant gripping surfaces

Time-tested design normally found only in industrial-grade chucks

Most popular chuck sold in the world

Constructed of high quality materials for lasting life and performance

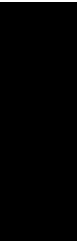

Jacobs® Hand-Tite® Keyless Drill Chucks

- Split Bite Jaw: Increases Grip Over Standard Bite Chucks By Providing More Contact with the Bit
- Superior Gripping Force: Provides High Mechanical Advantage to Convert Hand Tightening Torque Into Superior Bit Gripping Force
- Hammerlock® Mechanism: Positive Locking Mechanism Prevents Loosening in Hammer and Other High Vibration Applications
- Anti-Lock Nut: Prevents Chuck From Locking Open
- Versatility: Models Available to Fit All 10mm (3/8") and 13mm (1/2") Variable Speed Corded and Cordless Portable Drills
- Precision Operation: Meet or Exceed Stringent DIN Run-Out and Dimensional Specifications
- Ergonomic Design: Material and Surface Finish Combinations Result in Increased Comfort and Performance
- Rugged Construction: Constructed of High Performance Material to Maximize Durability and Performance



Cat. No.	UPC No.	Packaging	Model No.	Min. Capacity	Max. Capacity	Mount	Closed Length	Sleeve Dia.	Product Weight
30354	095456303546	Boxed	510-2H	0.040 in	0.375 in	3/8-24	2.00 in	1.68 in	0.50 lb
31037D	095456310377	Boxed	513-2M	0.062 in	0.500 in	3/8-24	2.9 in	1.68 in	0.63 lb
31038D	095456310384	Boxed	513-2M	0.062 in	0.500 in	1/2-20	2.9 in	1.68 in	0.70 lb

Jacobs® Professional Duty Chucks

- Industrial Quality
- Through-Hardened Jaws Provide Hard, Durable Gripping Surfaces
- One-Piece Sleeve Eliminates Crack Between Driving Teeth Often Found in Other Designs
- Fluted Sleeve Finish
- Each Chuck 100% Inspected for Performance and Precision



Cat. No.	UPC No.	Packaging	Model No.	Min. Capacity	Max. Capacity	Mount	Key No.	Closed Length	Open Length	Sleeve Dia.	Product Weight
31052D	095456310520	Boxed	26BA-1/2	0.063 in	0.5 in	1/2-20	KK	3 in	2.3 in	1.72 in	1.38 lb
30246D	095456302464	Boxed	41BA-3/8	0.063 in	0.375 in	3/8-24	K30	2.42 in	1.89 in	1.42 in	0.31 lb

Jacobs® Multi-Craft® Drill Chuck

- Offered in 1/4", 3/8" and 1/2" Capacities
- Through-Hardened Jaws for Hard, Wear Resistant Gripping Surfaces



Cat. No.	UPC No.	Packaging	Min. Capacity	Max. Capacity	Mount	Key No.	Closed Length	Open Length	Sleeve Dia.	Product Weight
30243D	095456302433	Boxed	0.028 in	0.25 in	3/8-24	KG1	2.02 in	1.575 in	1.13 in	0.30 lb
30247D	095456302471	Boxed	0.062 in	0.375 in	3/8-24	KG1	2.312 in	1.85 in	1.22 in	0.70 lb
30598	095456305984	Boxed	0.078 in	0.5 in	3/8-24	KK	2.855 in	2.25 in	1.61 in	0.65 lb
30602	095456306028	Boxed	0.078 in	0.5 in	1/2-20	KK	2.855 in	2.25 in	1.61 in	0.16 lb

Jacobs® Adapt-A-Drive® Chuck

- Easy Conversion-Integral Hex Mount Locks the Adapt-A-Drive Chuck Into the Screwdriver Bit Socket
- Ideal for Use in Starting Screw Holes for Use in Hard-To-Reach Spaces



Cat. No.	UPC No.	Packaging	Min. Capacity	Max. Capacity	Mount	Key No.	Sleeve Dia.	Product Weight
30248D	095456302488	Boxed	0.028 in	0.25 in	0.250" Hex	KG1	1.13 in	0.45 lb

Jacobs® Chuck Keys

- Nickel Thumb Grip Styles Increase Leverage and User Comfort
- Soft Steel Handles Limit the Potential for Dangerous Fracturing Under Excessive Load
- Self-Ejecting Models with Spring-Loaded Ejectors Ensure Key Disengagement After Tightening
- Never Apply Extensions, Pliers, Wrenches or 'Cheaters' of Any Kind to Chuck Key Handles
- Do Not Subject Chuck Key Handles to Hammer or Other Impact Blows



Cat. No.	UPC No.	Packaging	Model No.	Pilot Size	Used On	Handle Style	No. Teeth	Product Weight
30827D	095456308275	Bagged	-	13/64 in	1/4 & 3/8" chucks	T-handle	11	0.07 lb
3637	095456036376	Bagged	K0	1/8 in	0 Series	T-handle	11	0.04 lb
3639	095456036390	Bagged	K0M	1/8 in	0 Series Stainless	T-handle	11	0.05 lb
3641	095456036413	Bagged	K1	5/32 in	1 Series	T-handle	11	0.04 lb
3643	095456036437	Bagged	K1M	5/32 in	1 Series Stainless	T-handle	11	0.60 lb
3649D	095456036499	Bagged	K2	1/4 in	2 Series	Thumb Handle	11	0.13 lb
3651D	095456036512	Bagged	K3	5/16 in	3, 34 Series & 14N	Thumb Handle	11	0.55 lb
3653	095456036536	Bagged	K3C	5/16 in	34-33 C	Thumb Handle	11	0.00 lb
3655DD	095456036550	Bagged	K4	3/8 in	36, 16, 18N	Thumb Handle	12	0.34 lb
3657	095456036574	Bagged	K5	7/16 in	20N	T-handle	12	0.68 lb
3659D	095456036598	Bagged	K7	7/32 in	7 Series	Thumb Handle	11	0.06 lb
3664	095456036642	Bagged	K30	15/64 in	31 Series & 8-1/2N	Thumb Handle	10	0.15 lb
3666	095456036666	Bagged	K32	1/4 in	32,33 Series& 11N	Thumb Handle	10	0.55 lb
14273D	095456142732	Bagged	KG1	1/4 in	1/4 & 3/8" Multi-Craft® (black handle)	T-handle	11	0.04 lb
3605	095456036055	Bagged	KGA	1/4 in	1/4 & 3/8" Multi-Craft®	L-handle	11	0.00 lb
30052D	095456300521	Bagged	KK	9/32 in	DC8, SM8, 74K, 22BA, 23BA, 24BA, 26BA, 29-33,	T-handle	10	0.10 lb

Jacobs® Key Leashes



Cat. No.	UPC No.	Packaging	Model No.	Used On	Product Weight
3685D	095456036857	Bagged	Model A	K0, K1, K7, KG	0.02 lb
3686D	095456036864	Bagged	Model B	K30, K32, K2, KK	0.02 lb



C **CRESCENT**
BRAND

Adjustable Wrenches 496

Locking Pliers 497



Lufkin

Measuring Tapes 500



WISS

Snips 501

Utility Knives 502

Chrome Plated Adjustable Wrenches, Second Generation

- World Famous Crescent® Brand
- Wider Knurl for Easier Adjustment
- Laser Etched Scale Provides a Quick and Convenient Way to Determine Fastener Size in Either SAE or Metric
- Wide Capacity Jaw Allows Each Tool to Work with More Fastener Sizes
- Wider Handle Provides More Comfort and Less Stress to the Hand
- Tension Spring Stabilizes Jaw and Knurl Adjusts Easily
- Alloy Steel and Heat Treated
- Proportioned Dimensions for Greatest Strength and Minimum Weight
- Chrome Plated Finish Resists Rust and Corrosion
- Polished Head and Regular, Satin Finished Handle



Cat. No.	UPC No.	Packaging	Jaw Capacity	Length	Product Weight	Shelf Pack Qty.
AC24BK	037103265050	Bagged	0.500 in	4.000 in	0.13 lb	6
AC24VS	037103253972	Carded	0.500 in	4.000 in	0.16 lb	3
AC26BK	037103265067	Bagged	0.938 in	6.000 in	0.34 lb	6
AC26VS	037103253989	Carded	0.938 in	6.000 in	0.38 lb	3
AC28BK	037103265074	Bagged	1.125 in	8.000 in	0.60 lb	6
AC28VS	037103253996	Carded	1.125 in	8.000 in	0.62 lb	3
AC210BK	037103265081	Boxed	1.313 in	10.000 in	1.20 lb	6
AC210VS	037103254009	Carded	1.313 in	10.000 in	1.06 lb	3
AC212BK	037103265098	Boxed	1.500 in	12.000 in	1.92 lb	6
AC212VS	037103254016	Carded	1.500 in	12.000 in	1.81 lb	3

Tapered Handle Chrome Plated Adjustable Wrenches, Second Generation

- World Famous Crescent® Brand
- Wider Knurl for Easier Adjustment
- Laser Etched Scale Provides a Quick and Convenient Way to Determine Fastener Size in Either SAE or Metric
- Tension Spring Stabilizes Jaw and Knurl Adjusts Easily
- Alloy Steel and Heat Treated
- Proportioned Dimensions for Greatest Strength and Minimum Weight
- Chrome Plated Finish Resists Rust and Corrosion
- Tapered, Satin Finished Handle for Better Two-Hand Grip and Less Weight



Cat. No.	UPC No.	Packaging	Jaw Capacity	Length	Product Weight	Shelf Pack Qty.
AC215BK	037103265104	Boxed	1.688 in	15.000 in	3.00 lb	-
AC215VS	037103254023	Carded	1.688 in	15.000 in	3.00 lb	-
AC218BK	037103265111	Boxed	2.063 in	18.000 in	4.92 lb	-
AC218VS	037103254030	Carded	2.063 in	18.000 in	4.92 lb	-
AC224BK	037103265128	Boxed	2.438 in	24.000 in	8.71 lb	-
AC224VS	037103254047	Carded	2.438 in	24.000 in	8.71 lb	-

CRESCENT 5 Pc. Locking Pliers Set, Curved Jaw and Long Nose

- World Famous Crescent® Brand
- Maximum Jaw Opening Per ASME Specs
- Angled Tooth Pattern for Better Grip
- Nickel-Plated Finish Resists Rust and Corrosion
- Compound Action for Powerful Non-Slip Locking Grip
- Long Nose with Wire Cutter Gets to Hard-To-Reach Spots
- Versatile Curved Jaw Also Features Integral Wire Cutter



Cat. No.	UPC No.	Packaging	Product Weight
CLP5SET	037103202895	Carded	4.06 lb

Cat. No.	Description	Cat. No.	Description
C6NV	6" Long Nose Locking Plier With Wire Cutter	C5CV	5" Curved Jaw Locking Plier With Wire Cutter
C9NV	9" Long Nose Locking Plier With Wire Cutter	C10CV	10" Curved Jaw Locking Plier With Wire Cutter
C7CV	7" Curved Jaw Locking Plier With Wire Cutter		

CRESCENT 3 Pc. Cushion Grip Curved Jaw Locking Pliers Set

- World Famous Crescent® Brand
- Maximum Jaw Opening Per ASME Specs
- Angled Tooth Pattern for Better Grip
- Nickel-Plated Finish Resists Rust and Corrosion
- Compound Action for Powerful Non-Slip Locking Grip
- Versatile Curved Jaw Also Features Integral Wire Cutter



Cat. No.	UPC No.	Packaging	Jaw Type	Product Weight
CLP3SETC	037103202888	Carded	Curved	2.65 lb

CRESCENT 3 Pc. Curved Jaw Locking Pliers Set

- World Famous Crescent® Brand
- Maximum Jaw Opening Per ASME Specs
- Angled Tooth Pattern for Better Grip
- Nickel-Plated Finish Resists Rust and Corrosion
- Compound Action for Powerful Non-Slip Locking Grip
- Versatile Curved Jaw Also Features Integral Wire Cutter



Cat. No.	UPC No.	Packaging	Jaw Type	Product Weight
CLP3SET	037103202871	Carded	Curved	2.54 lb

2 Pc. Curved Jaw Locking Pliers Set

- World Famous Crescent® Brand
- Maximum Jaw Opening Per ASME Specs
- Angled Tooth Pattern for Better Grip
- Nickel-Plated Finish Resists Rust and Corrosion
- Compound Action for Powerful Non-Slip Locking Grip
- Versatile Curved Jaw Also Features Integral Wire Cutter



Cat. No.	UPC No.	Packaging	Jaw Type	Product Weight
CLP2SET	037103202864	Carded	Curved	2.07 lb

Straight Jaw Locking Pliers

- World Famous Crescent® Brand
- Maximum Jaw Opening Per ASME Specs
- Angled Tooth Pattern for Better Grip
- Nickel-Plated Finish Resists Rust and Corrosion
- Compound Action for Powerful Non-Slip Locking Grip
- Versatile Curved Jaw Also Features Integral Wire Cutter



Cat. No.	UPC No.	Packaging	Overall Length	Jaw Capacity	Jaw Type	Wire Cutter	Product Weight
C7SV	037103206664	Carded	7 in	1-5/16 in, 34 mm	Curved	No	0.90 lb
C10SV	037103206800	Carded	10 in	1-3/4 in, 45 mm	Straight	No	1.30 lb

Curved Jaw Locking Pliers with Wire Cutter

- World Famous Crescent® Brand
- Maximum Jaw Opening Per ASME Specs
- Angled Tooth Pattern for Better Grip
- Nickel-Plated Finish Resists Rust and Corrosion
- Compound Action for Powerful Non-Slip Locking Grip
- Versatile Curved Jaw Also Features Integral Wire Cutter



Cat. No.	UPC No.	Packaging	Overall Length	Jaw Capacity	Jaw Type	Wire Cutter	Product Weight
C7CV	037103206695	Carded	7 in	1-5/8 in, 42 mm	Curved	Yes	0.85 lb
C5CV	037103206817	Carded	5 in	1-1/4 in, 32 mm	Curved	Yes	0.42 lb
C10CV	037103206701	Carded	10 in	1-7/8 in, 48 mm	Curved	Yes	1.19 lb

Long Nose Locking Pliers with Wire Cutter

- World Famous Crescent® Brand
- Maximum Jaw Opening Per ASME Specs
- Angled Tooth Pattern for Better Grip
- Nickel-Plated Finish Resists Rust and Corrosion
- Compound Action for Powerful Non-Slip Locking Grip
- Long Nose with Wire Cutter Gets to Hard-To-Reach Spots
- Versatile Curved Jaw Also Features Integral Wire Cutter



Cat. No.	UPC No.	Packaging	Overall Length	Jaw Capacity	Jaw Type	Wire Cutter	Product Weight
C6NV	037103206718	Carded	6 in	2-1/4 in, 58 mm	Long Nose	Yes	0.45 lb
C9NV	037103206725	Carded	8-3/4 in	2-7/8 in, 73 mm	Long Nose	Yes	0.92 lb

Locking C-Clamps, Regular Tips

- World Famous Crescent® Brand
- Maximum Jaw Opening Per ASME Specs
- Nickel-Plated Finish Resists Rust and Corrosion
- Compound Action for Powerful Non-Slip Locking Grip
- Locking "C" Clamps Are Faster and Easier to Use Than Standard Clamps



Cat. No.	UPC No.	Packaging	Overall Length	Jaw Capacity	Jaw Type	Wire Cutter	Product Weight
C6CCV	037103206732	Carded	6 in	2 in, 51 mm	C-Clamp/Regular Tips	No	0.55 lb
C11CCV	037103206756	Carded	11 in	4 in, 102 mm	C-Clamp/Regular Tips	No	1.95 lb
C18CCR	037103217301	Carded	18 in	8 in, 203 mm	C-Clamp/Regular Tips	No	2.59 lb

Locking C-Clamps, Swivel Pad Tips

- World Famous Crescent® Brand
- Maximum Jaw Opening Per ASME Specs
- Nickel-Plated Finish Resists Rust and Corrosion
- Compound Action for Powerful Non-Slip Locking Grip
- Locking "C" Clamps Are Faster and Easier to Use Than Standard Clamps



Cat. No.	UPC No.	Packaging	Overall Length	Jaw Capacity	Jaw Type	Wire Cutter	Product Weight
C6CCSV	037103206749	Carded	6 in	2-1/8 in, 73 mm	C-Clamp/Swivel Pads	No	0.62 lb
C11CCSV	037103206763	Carded	11 in	4 in, 102 mm	C-Clamp/Swivel Pads	No	1.86 lb
C18CCS	037103217271	Carded	18 in	8 in, 203 mm	C-Clamp/Swivel Pads	No	2.71 lb

Locking Sheet Metal Clamp and Welder's Clamp

- World Famous Crescent® Brand
- Maximum Jaw Opening Per ASME Specs
- Angled Tooth Pattern for Better Grip
- Nickel-Plated Finish Resists Rust and Corrosion
- Compound Action for Powerful Non-Slip Locking Grip
- Long Nose with Wire Cutter Gets to Hard-To-Reach Spots
- Versatile Curved Jaw Also Features Integral Wire Cutter
- Locking "C" Clamps Are Faster and Easier to Use Than Standard Clamps



Cat. No.	UPC No.	Packaging	Overall Length	Jaw Capacity	Jaw Type	Wire Cutter	Product Weight
C8SMV	037103206770	Carded	8 in	3/4 in, 19 mm	Sheet Metal Clamp	No	1.11 lb
C9W	037103206787	Boxed	9 in	1-1/2 in, 38 mm	U Shaped Welding	No	1.45 lb

Quick Release Locking Chain Clamp

- World Famous Crescent® Brand
- Nickel-Plated Finish Resists Rust and Corrosion
- Compound Action for Powerful Non-Slip Locking Grip



Cat. No.	UPC No.	Packaging	Overall Length	Jaw Capacity	Jaw Type	Wire Cutter	Product Weight
C20CH	037103206794	Boxed	9 in	18 in	Chain Clamp	No	1.62 lb

Lufkin® Series P1000

- Hi-Viz® Orange Case - Easy to Find on the Job
- Rubber Cushion Case Exterior Protects Tape From Impact and Improves Grip
- Fits Easily Into Most Tape Holsters
- Bright Yellow Blade Has Clear Easy-To-Read Numerals
- Toggle Lock is Positioned for Convenient Operation
- Holds the Blade Securely in Any Position
- Cushioned Blade Return



Cat. No.	UPC No.	Packaging	Case Color	Blade Width	Blade Length	Blade Style	Replacement Blade Cat No.	Product Weight
PHV1433	037103252081	Carded	Hi-Viz® Orange	1 in	33 ft	A5	None	1.34 lb
PHV1433DM	037103252098	Carded	Hi-Viz® Orange	25 mm, 1 in	10 m, 33 ft	A29	None	1.34 lb
PHV1410CME	037103252074	Carded	Hi-Viz® Orange	25 mm, 1 in	10 m, 33 ft	A30	None	1.34 lb
PHV1425	037103252005	Carded	Hi-Viz® Orange	1 in	25 ft	A5	None	1.07 lb
PHV1425D	037103252012	Carded	Hi-Viz® Orange	1 in	25 ft	A4	None	1.07 lb
PHV1425ED	037103252029	Carded	Hi-Viz® Orange	1 in	25 ft	A35	None	1.07 lb
PHV1048CM	037103251978	Carded	Hi-Viz® Orange	25 mm	8 m	A9	None	1.07 lb
PHV1048CME	037103251985	Carded	Hi-Viz® Orange	25 mm, 1 in	8 m, 26 ft	A30	None	1.07 lb
PHV1048DM	037103251992	Carded	Hi-Viz® Orange	1 in	25 ft	A29	None	1.07 lb
PHV1316	037103251930	Carded	Hi-Viz® Orange	3/4 in	16 ft	A2	RW316	0.62 lb
PHV1035CM	037103251916	Carded	Hi-Viz® Orange	19 mm	5 m	A9	None	0.62 lb
PHV1035CME	037103251923	Carded	Hi-Viz® Orange	19 mm, 3/4 in	5 m, 16 ft	A13	RY35CME	0.62 lb
PHV1312	037103251848	Carded	Hi-Viz® Orange	3/4 in	12 ft	A2	R1312	0.60 lb
PHV1312D	037103251855	Carded	Hi-Viz® Orange	3/4 in	12 ft	A4	None	0.60 lb
PHV1034CME	037103251824	Carded	Hi-Viz® Orange	19 mm, 3/4 in	4 m, 13 ft	A13	None	0.60 lb
PHV1034DM	037103251831	Carded	Hi-Viz® Orange	19 mm, 3/4 in	3.7 m, 12 ft	A29	None	0.60 lb
PHV1012	037103251770	Carded	Hi-Viz® Orange	1/2 in	12 ft	A1	RY212	0.32 lb
PHV1024CME	037103251787	Carded	Hi-Viz® Orange	13 mm, 1/2 in	4 m, 13 ft	A13	None	0.32 lb
PHV1010	037103251701	Carded	Hi-Viz® Orange	1/2 in	10 ft	A1	RY210	0.29 lb
PHV1023CM	037103251718	Carded	Hi-Viz® Orange	13 mm	3 m	A9	None	0.29 lb
PHV1023CME	037103251725	Carded	Hi-Viz® Orange	13 mm, 1/2 in	3 m, 10 ft	A13	RY23CME	0.29 lb

Lufkin® Quickread® Power Tapes

- Graduations Printed in Fractions and Decimal Equivalents
- Rubber Cushion Case Exterior Protects Tape From Impact and Improves Grip
- Positive Toggle Lock Holds Blade Securely at Any Length
- Self-Compensating End Hook for Inside and Outside Measurements
- Durable ABS Case Withstands Rugged Use on the Job Site
- Built in Bumper Reduces Shock When Blade is Retracted
- Blade Style: A3



Cat. No.	UPC No.	Packaging	Case Color	Blade Width	Blade Length	Blade Style	Replacement Blade Cat No.	Product Weight
PQR1312	037103251862	Carded	Hi-Viz® Orange	3/4 in	12 ft	A3	None	0.60 lb
PQR1316	037103251947	Carded	Hi-Viz® Orange	3/4 in	16 ft	A3	None	0.62 lb
PQR1425*	037103252036	Carded	Hi-Viz® Orange	1 in	25 ft	A3	None	1.07 lb

* Patented End Hook Lasts 10 Times Longer Than Ordinary End Hooks

Wiss® M3R Aviation Snips

- Straight cut, cuts straight and slight curves
- Cuts low carbon cold rolled steel
- Non-slip serrated jaw of tough molybdenum steel holds material firmly and uniformly spreads cutting force across blade edge
- Withstands strain of cutting heavy stock
- Spring-action for fast, effortless feed
- Non-slip, textured grips and safety latch
- Yellow handles for ease of identification



Cat. No.	UPC No.	Packaging	Tool Length	Blade Length	Cutting Capacity	Product Weight
M3R	037103580214	Carded	9-3/4 in	1-1/2 in	18 Gauge Low Carbon Steel	0.90 lb

Wiss® M1R Aviation Snips

- Left cut, cuts left from tight curves to straight
- Cuts low carbon cold rolled steel
- Non-slip serrated jaw of tough molybdenum steel holds material firmly and uniformly spreads cutting force across blade edge
- Withstands strain of cutting heavy stock
- Spring-action for fast, effortless feed
- Non-slip, textured grips and safety latch
- Red handles for ease of identification



Cat. No.	UPC No.	Packaging	Tool Length	Blade Length	Cutting Capacity	Product Weight
M1R	037103580122	Carded	9-3/4 in	1-3/8 in	18 Gauge Low Carbon Steel	0.40 lb

Wiss® M2R Aviation Snips

- Right cut, cuts right from tight curves to straight
- Cuts low carbon cold rolled steel
- Non-slip serrated jaw of tough molybdenum steel holds material firmly and uniformly spreads cutting force across blade edge
- Withstands strain of cutting heavy stock
- Spring-action for fast, effortless feed
- Non-slip, textured grips and safety latch
- Green handles for ease of identification



Cat. No.	UPC No.	Packaging	Tool Length	Blade Length	Cutting Capacity	Product Weight
M2R	037103580184	Carded	9-3/4 in	1-3/8 in	18 Gauge Low Carbon Steel	0.40 lb

Wiss® Auto-Retracting Utility Knife

- Blade retracts automatically the moment it loses contact with the material being cut – even if the user is still holding the blade slider forward in the ‘open’ position
- Helps reduce workplace injuries, lowering lost time and increasing productivity
- Accepts all standard type utility knife blades
- Quick and easy blade change



Cat. No.	UPC No.	Packaging	Product Weight
WKAR1	037103240262	Carded	0.40 lb

Wiss® Quick-Change Folding Blade Utility Knife

- Blade safely folds into handle for compact size and easy storage
- Quick blade change for easy and fast replacement
- Soft grip ergonomic handle design for increased comfort
- Accepts all standard type utility knife blades
- Includes bonus 10 pack of blades



Cat. No.	UPC No.	Packaging	Product Weight
WKF1	037103250841	Carded	0.55 lb

Wiss® Utility Blades

- Wiss Utility Knife Blades are High Quality Steel
- Replacement Blades Fit most Utility Knives
- Heavy-Duty Blades with Sharp Points
- Cat. No. RWK18D Features Round Tips to Help Prevent Puncturing



Cat. No.	UPC No.	Packaging	Number of Blades	Product Weight
RWK14D	037103151773	Carded	100	0.97 lb
RWK14V	037103151445	Carded	5	0.02 lb
RWK16V	037103151414	Carded	5	0.06 lb
RWK18D	037103265326	Carded	100	0.96 lb

Numeral

120XP™ Ratchets
 Flex Head
 1/4" Drive 55,57,83,85
 3/8" Drive 55,57,124,126-127
 1/2" Drive 55,164
 1/4" Drive 56-57,67,83,85
 1/4" Drive
 Flex 55,83
 3/8" Drive 55-57,102,124,126-127
 3/8" Drive
 Flex 57,127
 1/2" Drive 55-56,149,164
 1/2" Drive
 Flex 55,164

A

A/C and Fuel Line Spring Lock Coupling Tool..... 401-402
Adapters
 Hand
 1/4" Drive 41,44,47,49,51,58-60,63,66,87,99
 3/8" Drive 51,53,58-60,66,130
 1/2" Drive 58-59,167
 Impact
 1/4" Drive 192,197
 3/8" Drive 207
 1/2" Drive 218
 3/4" Drive 226
Adjustable Wrenches.....12,14,23,312,496
Adjustable Wrenches
 Chrome Plated 496
Air Hold Extension Hose 400
Air Hold Fitting Set.....400
ALLEN® Hex Wrenches / Keys
 Fold-up Sets 485
 L Keys... 9-10,16,18,20,23,38,41,44,47,51,486-488
 T-Handles 489-490
Angled Hose Clamp Pliers357,398
Angle Finder 476
Automatic Transmission Clutch-Spring Compressor468
Auto Transmission Line Disconnect... 388,403-404
Aviation Snips 14,17,23,501
Awl 13,17,428-429
Axle Nut Socket.....391,450
Axle Nut Socket
 Set.....391,450

B

Ball Joint
 Separator 464-465
 Separator Universal 390,464,466
Battery
 Brush 421
 Carrying Strap 421
 Nut Pliers 356,420
 Terminal Puller 420
 Terminal Spreader and Cleaner 420
 Tool Three-Way 421
Bearing
 Bearing and Seal Puller 469
 Bearing Packer, Hand 453
 Puller Set, Rear Axle 392,480
Bearing Race and Seal Set.....391,452
Bendix Drum Brake Spring Tool.....437
Bits, Screwdriving 286,332-333,336-337
Bit Sockets 13,16,18,20,41,44,47,49,51,61-66,81-82,96-99,103-104,121-123,141-146,163,174-175,388,436

Bit Sockets

Bit Holders 63,145
 Hex 18,61,65,81-82,96,103-104,121-123,141-143,388,436
 Screwdriver 123,146
 Sets 61-65,81-82,121-123,163
 Torx® 13,16,18,20,49,61-64,66,82,97-99,123,144-146,388,436
 Triple Square 65-66,82,96,143,174
Body Tools, Vehicle..... 13,17,377,430-431,433-434
Body Tools, Vehicle
 Clip Set 431
 Dent Remover 434
 Trim Pad set 430
 Trim Tools 13,17,430-431,433

Box Wrenches 309-310

Brake

Adjusting Tool Drum 15,388,436-438
 and Engine Cylinder Hone Set 446
 Bleeder Adapter 441-442
 Bleeder Tank 439-440
 Cylinder Hone 446
 Drum Gauge Digital 449,474
 Lining Gauge 388,436,447
 Pad Spreader, Disc 438
 Piston Tool, Disc 388,436,438
 Resetting Gauge 448
 Service Set 388-389,436
 Shoe Retaining Spring Tool 15,388,436-438
 Spring Pliers 15,388,436-437
 Thickness Gauge 388,436,447,449,474

Brake and Wheel Tools, Vehicle 14-15,388-389,391-392,394,396,436-443,445-448,450-453,480

Breaker Bars 12,16,18,20,86,103-104,129,150-151,154,166,176-177

Breaker Bars

1/4" Drive 86
 3/8" Drive 103-104,129
 1/2" Drive 12,16,18,20,150-151,154,166
 3/4" Drive 176-177

Brushes 13,17,23,418-419

Brushes
 Stainless Steel 23,419
 Wire-End, Knot-type 418
 Wire Scratch, Shoe Handle 13,17,419

Bubble Flaring Tool Kit 395,444

Bushing Remover and Insert Set.....393-394,411

C

Cabinets, Tool
 TEP Series 31-32
 XL Series 27-29
Caliper Digital.....448,474
Carts
 XL Series 29-30
Chain Wrench 460
Chests, Tool
 TEP Series 30-32
 XL Series 27-28
Chisels 9-10,15,17,19,23,377-379
Chisels
 Sets 378
Chuck Keys 494
Chucks
 Adapt-A-Drive® Chuck 494
 Hand-Tite® 493
 Keyleashes 494
 Multi-Craft® Chucks 493
 Professional 493
Circuit and Spark Plug Tester 423
Circuit Continuity Tester 422

Circuit Tester 9-10,15,17,19,422

Clutch Alignment Set 468

Coil Spring Compressor 467

Combined Double / Bubble Flaring Tool Kit 396,443

Compression Tester 399

Corbin Style Hose Clamp Pliers 357,397

Crankshaft Holding Tool, Honda Acura 409

Crowfoot Wrenches 120,140,307-309

Crowfoot Wrenches

Ratcheting 119,139,305-307
 3/8" Drive 119-120,139-140,305-309

Current Indicator 424

CV Boot

Clamp Tightening Wrench 467
 Clamp Tool 467

Cylinder Head Rethreader Kit.....425

Cylinder Hone Replacement Stones 415,446

D

Deburring Tool..... 14,394-396,443-445

Dent Puller..... 434

Dial Indicator 448,475

Diesel Compression Test Kit 399

Diesel Ring Compressor 414

Disc Brake

Pad Separator - Heavy Duty 388,436,439
 Pad Spreader 438
 Piston Tool 15,388,436,438
 Rotor/Ball Joint Gauge 449,474

Distributor Clamp Wrench..... 424

Door Handle and Window Lift Remover... 13,17,433

Door Panel Removers 430

Double Flaring Tool Kit 395,444

Double-X™ Pliers 15,17,19,352-355

Drive Tools and Accessories

Hand 58-60
 Hand
 1/4" Drive 9-11,16,18,20-21,23,38,41,44,47,49,51-52,54,56-60,63,66-74,83-89,99
 3/8" Drive 9-11,16,18,20-21,23,38,41,44,47,49,51-53,58-60,66,100-111,129-132
 1/2" Drive 10-12,16,18,20,38,41,44,47,49,58-60,147-155,166-168

E

Engine/Automatic Trans. Oil Pressure Check Kit ... 400

Engine

Cylinder Flex-Hone 415
 Cylinder Hone 414
 Cylinder Ridge Reamer 414
 Valve Spring Compressor Small 416

Engine Tools, Vehicle 12,388-389,392-394,398-410,412-418,424-427,455-461,476

Exhaust and Tailpipe

Cutter 418
 Expander 418

Extensions 9-10,16,18,20-21,23,38,41,44,47,49,51-53,59-60,66-74,88-89,100-111,131-132,147-155,167-169,176-177,179-181,188

Extensions

Hand 9-10,16,18,20-21,23,38,41,44,47,49,51-53,59-60,66-74,88-89,100-111,131-132,147-155,167-169,176-177,179-181,188
 Hand
 1/4" Drive 9-10,16,18,20-21,23,38,41,44,47,49,52,59-60,66-74,88-89

3/8" Drive 202-204
 1/2" Drive 212-215
 Impact Sockets 191-204,206,208-209,211-217,219-222,224-228
 Impact Sockets
 Hex Bit / Driver Sockets 205,210,216,223
 High Strength 216
 Thin Wall, Wheel Protector 216
 Universal Sockets 191-192,196-197,201,206,211,217,224-225
 1/4" Drive 191-196,198-200
 3/8" Drive 202-204,208-209
 1/2" Drive 212-215,219-222
 3/4" Drive 226-228
Inner Tie Rod Tool 466
Inspection Mirrors 10,15,17,19,21,23,476-477

F

Fan Clutch Pulley Holder
 Set 409
Fan Clutch Service
 Set 389,408
Fan Clutch Wrench 389,408-409
Feeler Gauges 9-10,15,19,23,472-474
Fender Cover 481
Files
 American Pattern 10,17,23,371-372
 American Pattern
 Flat Bastard 10,17,23,371-372
 Half Round 10,17,23,371-372
 Round Bastard 10,17,23,371-372
Flare Nut Wrenches 12,14,302-305
Flare Nut Wrenches
 Flex 302-303
 Ratcheting 301-302
Flashlight 9-10,16-17,20,23,481
Flex Head Ratchets
 1/4" Drive 54-55,57,83-85
 1/4" Drive
 120XP™ Ratchets 55,57,83,85
 3/8" Drive 54-55,57,124-127,164
 3/8" Drive
 120XP™ Ratchets 55,57,124,126-127
 1/2" Drive 54,165
 1/2" Drive
 120XP™ Ratchets 55,164
Flex Sockets 23,66,81,95,118,138
Flex T / Breaker Bars 12,16,18,20,86,103-104,129,150-151,154,166,176-177
Flywheel Turner 399
Fold-up Sets 485
Front End Service Set 390,464
Fuel & Trans Line Disconnect Set 388,403
Fuel and Oil Filter Wrench 456
Fuel Filter Tool 405
Fuel Line
 Coupling Tool Ford 388,402-403
 Disconnect 388,403-404
 Disconnect Set, Low profile 402
 Kit 401
 Quick Disconnect Tool 388,401-403
Fuel Pump Vacuum and Pressure Tester 405

G

Gauges, Feeler 9-10,15,19,23,472-474
Gear Pullers 477-479
Gear Pullers
 Ratcheting Pullers 477-479
GearRatchet™ Handle 182

General Purpose Bushing Set 393,411
Gloves 481

H

Hacksaw Frames 10,15,17,19,23
Hacksaw Frames
 Cushion Grip 10,15,17,19,23
Half Moon Wrenches 282-283
Hammers 9-10,13-15,17,19,23,375-377
Hammers
 Ball Pein 9-10,15,17,19,23,375
 Claw 14,375
 Dead Blow 375-376
 Drilling 10,15,17,19,375
 Engineer's 376
 Rubber Mallet 10,15,17,19,375-376
 Sets 375
 Soft Face 9-10,15,17,19,23,375-376
Hand Bearing Packer 453
Harmonic Balancer Installer 412
Harmonic Balancer Puller Set 412
Hex Bit / Driver Sockets
 Hand
 1/4" Drive 66,81-82,96
 3/8" Drive 18,61,65,103-104,121-123,141-143,388,436
 1/2" Drive 65,163,174
 Impact 205,210,216,223
 Impact
 3/8" Drive 205,210
 1/2" Drive 216,223
Hex Keys
 Fold-up Sets 485
 L Keys... 9-10,16,18,20,23,38,41,44,47,51,486-488
 T-Handles 489-490
High-Low Voltage Tester 422
Hog Ring Pliers 432-433
Hooks & Picks 13,17,428-430
Hooks & Picks
 Sets 428,481
Hose Clamp Pliers Large 357,398
Hose Pinch-Off Pliers 357-358,396-397
HVAC Tools
 Ratcheting Wrench 14,280
Hydraulic Clutch Ln Disc 388,403,468

I

Ignition File 424
Ignition Tester
 HEI 423
 Standard 423
Impact Driver Set, Hand 369,454,482
Impact Tool Sockets and Accessories, Power 58,191-228
Impact Tool Sockets and Accessories, Power
 Impact Drive Tools 58,192,197-198,202,207,218,225-226
 Impact Drive Tools
 Adapters 207,218,226
 Universal Joints 58,207,218
 Impact Extensions 192,197,202,207,218,225
 Impact Extensions
 3/8" Drive 202,207
 1/2" Drive 218
 3/4" Drive 225
 Impact Hex Bits / Drivers 205,210,216,223
 Impact Hex Bits / Drivers
 3/8" Drive 205,210
 1/2" Drive 216,223
 Impact Sets 191-196,202-204,212-215
 Impact Sets
 1/4" Drive 191-196

3/8" Drive 202-204
 1/2" Drive 212-215
 Impact Sockets 191-204,206,208-209,211-217,219-222,224-228
 Impact Sockets
 Hex Bit / Driver Sockets 205,210,216,223
 High Strength 216
 Thin Wall, Wheel Protector 216
 Universal Sockets 191-192,196-197,201,206,211,217,224-225
 1/4" Drive 191-196,198-200
 3/8" Drive 202-204,208-209
 1/2" Drive 212-215,219-222
 3/4" Drive 226-228
Inner Tie Rod Tool 466
Inspection Mirrors 10,15,17,19,21,23,476-477

K

Keyless Chucks
 Portable Tools 493
Knives 9-10,16-17,20,23

L

L Keys 9-10,16,18,20,23,38,41,44,47,51,486-488
Locking Extensions 169
Lock Nut Tool 391,451
Low-Voltage Circuit Tester 9-10,15,17,19,422

M

Macpherson Strut Spring Compressor 467
Magnetic Drive Tools 58-59
Magnetic Drive Tools
 Adapters 60
 Adapters
 1/4" Drive 59-60,87
 3/8" Drive 59-60,130
 Extensions, Socket
 1/4" Drive 59-60,88
 3/8" Drive 59-60,131
 1/2" Drive 59-60,168
 Swivel Spark Plug Sockets
 3/8" Drive 124,130
 Universal Joints 59
 Universal Joints
 1/4" Drive 59,87
 3/8" Drive 59,129
 1/2" Drive 59,167
Magnetic Oil Drain Plug Sockets
 Individual Sockets 462
 Sets 462
Magnetic Parts Tray 34
Magnetic Pickup Tool 15,17,19,21,23,477
Mallet, Rubber 10,15,17,19,375-376
Master Bolt Grip Set 390,412
Measuring
 Precision 448-449,474-476
 Tape Measures, Power Return 500
 Tape Measures, Power Return
 Power Tapes 500
Mechanics Tool Sets 38-53,66-74,100-111,147-155,176,179-181
Mini Screwdrivers 321,327-329,344
Mirrors, Inspection 10,15,17,19,21,23,476-477
Multi-Craft® Chucks 493

N

Nut Cracker
 Universal 371,454,482
Nutdrivers 14,332,338-340
Nutdrivers
 Hollow Shaft 14,339-340

Hollow Shaft
Set..... 339-340
Ratcheting..... 332,338-339
Shafts..... 332,338-339

O

Oil Canister Socket
Set..... 394,461
Oil Cooler Line Disconnect ... 388-389,403-404,410
Oil Drain Plug Sockets
Magnetic
Individual Sockets..... 462
Sets 462
Oil Filter
Cap Wrench..... 394,457-458,461
Sockets 394,461
Strap Wrench Heavy Duty..... 461
Wrench 3-Jaw Universal..... 460
Wrench Adjustable..... 456
Wrench End Cap..... 457-458
Wrench Heavy Duty Wide Band 12,459-460
Wrench Nylon Strap..... 460
Wrench Pliers 459
Wrench Universal..... 456
Oil Pressure
Check Kit..... 400
Sending Socket Deep 392,405-406
Oil-Seal Remover and Installer 398
Oil Sender Socket..... 392,405
One-Man Brake Bleeder 439
O-Ring and Seal Pick 481
Overhead Valve Spring Compressor
Universal 417
Oxygen Sensor Socket..... 392,405-406
Oxygen Sensor Socket
Low Profile 392,405,407

P

P1000 Series, Tape Measures
Power Return Tapes 500
Panel Clip Pliers 431-432
Parts Cleaning Brush..... 419
Parts Tray 34
Pass-Thru™ Ratchet & Socket Sets (XL) 179-181
Pass-Thru™ Ratchet & Socket Sets (XL)
Vortex™ Sockets for Pass-Thru™ 179-187
Pickup Tool 15,17,19,21,23,477
Pipe Cutters..... 14
Pipe Wrench 14
Piston Ring Compressor 413
Piston Ring Compressor
Band..... 413
Heavy Duty 414
Pliers 413
Set..... 413
Piston Ring Groove Cleaner..... 414
Pitman Arm Puller..... 390,464,466
Pivot Pin Remover..... 390,463-464
Pliers..... 9-10,12-17,19-21,23,344-362,388,396-398,413,420,424-425,431-433,436-437,497-499
Pliers
Battery 356,420
Brake Spring..... 15,388,436-437
C-Clamps
Regular Tips..... 499
Swivel Pad Tips..... 17,499
Compound Action
Diagonal Cutting 351
Long Nose..... 351-352
Set..... 351
Diagonal Cutting..... 9-10,15,17,19,21,23,344-351,355-356

Diagonal Cutting
Heavy Duty 348,350
Double-X™ 15,17,19,352-355
End Cutting Nippers..... 15,344-347,351
Flat Nose 345,348
Hog Ring..... 432-433
Hose Clamp 357,397-398
Hose Pinch-Off 358,396-397
Insulated..... 355-356
Lineman's..... 15,344,346,348,350,355
Locking..... 9-10,16-17,20,23,497-499
Locking
Cushion Grip
Set 497
Locking Chain Clamp 499
Long Nose
Set 497
Regular Tips..... 499
Set 497-498
Swivel Pad Tips..... 17,499
Welder Clamp 499
Wire Cutter 9-10,16-17,20,23,497-498
Locking Chain Clamp
Quick Release 499
Lock Ring 358
Long Nose 348,350-352
Mini 344-345,347-348
Needle Nose..... 9-10,15,17,19,21,23,344-347,350
Panel Clip 431-432
Piston Ring, Compressing..... 413
Pivot Force
Diagonal Cutting 351
Long Nose..... 351-352
Set..... 351
Push Pin 13,17,431-432
Quick Release
Locking Pliers 499
Retaining Ring 15,17,23,358-362
Sets 344-345,348,351,355
Sheet Metal Clamp
Welder Clamp 499
Slip Joint 10,15,17,19,21,23,344-345,348-349
Tongue and Groove..... 9-10,12,15,17,19,21,23,344-345,348-349
Tongue and Groove
V-Jaw 349
Welder Clamp
Locking Pliers 499
Wire Stripper 14-15,17,19,21,23,356,424
Power Steering Pump Puller Set..... 389,410
Precision Measuring..... 448-449,474-476
Pro Swivoil Filter Wrench 455
Pry Bars 10,12,19,383-384
Pry Bars
Indexing..... 10,12,19,383-384
Pullers, Gear 477-479
Pulley Holder / Fan Clutch Tool Kit 408
Pulley Holder Universal 389,408
Pulley Puller and Installer Set..... 410
Punch & Chisel
Chisels..... 9-10,15,17,19,23,377-379
Sets..... 377-378
Punches..... 9-10,15-17,19-20,23,377-380
Push Pin Pliers 13,17,431-432
Push Pin Pliers
80 Degree..... 431-432
Set..... 431
PVS, TVS and O2 socket 392,405-406

Q

Quick Disconnect Chrysler..... 388,403
Quickread®
Power Return Tapes 500

R

Radio Removal Tool..... 396,435
Rails, Socket..... 33-34
Ratcheting
Screwdrivers 332-333
Ratcheting Wrenches 14,119,139,232-286,301-302,305-307
Ratchets 9,11,16,18,20-21,23,38,41,44,47,49,51-58,66-74,83-85,100-111,124-128,147-155,164-165,176-177,462
Ratchets
Flex Head
1/4" Drive 55,57,83,85
1/4" Drive
120XP 55,57,83,85
3/8" Drive 54-55,57,124-128
3/8" Drive
120XP 55,57,124,126-127
1/2" Drive 55,164
1/2" Drive
120XP 55,164
Gimbal
1/4" Drive 86
3/8" Drive 128
Pass-Thru™ 179-182
Repair Kits 85,129,166,177
Repair Kits
1/4" Drive 85
3/8" Drive 129
1/2" Drive 166
Tear Drop
Long Handle
1/4" Drive..... 55,84
3/8" Drive..... 55,125,127
1/2" Drive..... 165
1/4" Drive 9,11,16,18,20-21,23,38,41,44,47,49,52,54-57,66-74,83-85
3/8" Drive 9,11,16,18,20-21,23,38,41,44,47,49,51-58,100-111,124-128
1/2" Drive 11,16,18,20,38,41,44,47,49,54-56,147-155,164-165
1/4" Drive..... 55,57-58,66-69,83-86
3/8" Drive, 9,11,16,18,20-21,23,38,41,44,47,49,51-58,100-101,103-111,124-129
1/2" Drive .. 11,16,18,20,38,41,44,47,49,54-56,147-148,150-155,164-166
3/4" Drive..... 176-177
Rear Axle Bearing Puller Set..... 392,480
Remote Control Starter Switch..... 398
Retaining Ring Pliers 15,17,23,358-362,431
Rolls, Vinyl..... 14
Roto Ratchet
1/4" Drive 58,85
3/8" Drive..... 58,128
Rules, Measuring 475

S

Saws
Hacksaw Frames 10,15,17,19,23
Scraper 13,17,21,23,401
Scraper and Sticker Remover 13,17,435
Scraper Long Reach..... 435
Scraper Mini..... 435
Scraper Set..... 418
Screwdrivers..... 9-10,16-18,20-21,23,38,321-338,344,355
Screwdrivers
Cabinet Tip 329-330
Dual Material 9-10,16-18,20-21,23,321-327
Insulated..... 331-332,355

Interchangeable Bit 335
 Mini 321,327-329,344
 Offset 337
 Phillips 16,20-21,23,323,331,337,355
 Pozidriv 332,355
 Ratcheting Screwdriver 332-335,338
 Ratcheting Screwdriver
 LED lighted/Multi Bits 335
 Slotted 9-10,16,18,20-21,23,321-323,325,329-331,337,355
 Solid Handle 329-330
 Torx® 321,324,326

Screw Extractors 370

Screw Extractors
 Set 370

Screw Starters 10,16,20-21,23,337

Scriber 17,21,23,482

Seal and Pilot Bearing Puller 469

Seal Puller 411,469

Seal Puller

Oil-Seal Remover and Installer 398

Sensor & Sending Socket Set 392,405

Serpentine Belt Tool 407

Serpentine Belt Tool

Grabber 408
 Removal Set 407
 Stretch Tool 407

Serrated Wrench 401

Sets

Hex Bit / Driver Sockets
 1/2" Drive 163
 Impact
 Hex Bit / Driver Sockets 205,216
 Socket Chrome
 Flex 118,138
 1/4" Drive 23,66-81,95
 3/8" Drive 112-117
 1/2" Drive 147-163
 Socket Impact 191-196,202-204,212-215
 Socket Impact
 1/4" Drive 191-196
 3/8" Drive 202-204,206
 1/2" Drive 212-215

Short Circuit Detector 423

Side Terminal Battery Wrench 420

Slide Hammer 392,480

Slide Hammer Puller Set 392,480

Snap Rings

Assortment 469-470

Snips 14,17,23,501

Snips

Aviation, Left, Right, and Straight 14,17,23,501

Socket Clips 34

Socket Rails 33-34

Sockets 9,11-12,16,18,20-21,23,38-53,66-80,90-94,100-117,133-137,147-163,170-173,176,178

Sockets

Flex, Chrome
 1/4" Drive 23,66,81,95
 3/8" Drive 118,138
 Hand, Chrome
 3/8" Drive 9,11,16,18,20-21,23,39-40,42-43,45-48,50-53,100-117,124,130,133-137
 1/2" Drive 11-12,16,18,20,40,42-43,45-46,48,50,61-65,147-163,170-175
 Hex Driver
 13,16,18,20,41,44,47,49,51,61-66,81-82,96-99,103-104,121-123,141-146,163,174-175,388,436
 Impact
 191-204,206,208-209,211-217,219-222,224-228
 Impact
 Thin Wall, Wheel Protector 216
 1/4" Drive 191-196,198-200

3/8" Drive 202-204,208-209
 1/2" Drive 212-216,219-222
 3/4" Drive 226-228
 Sets 75-80,112-117,156-163
 Spark Plug 9,11,16,18,20,23,40,43,46,48,50-51,53,112,124,130,392-393,426-427
 Spark Plug
 3/8" Drive 9,11,16,18,20,23,40,43,46,48,50-51,53,112,124,130
 Torx® Tamper-Proof
 13,16,18,20,49,61-64,66,82,97-99
 Universal 23,66,81,95,118,138

Spark Plug

Gap Gauge 473-474
 Gap Wire Gauge 473
 Insert Reamer/Tap 426
 Magnetic 392-393,426-427
 Service Set 392-393,426-427
 Sockets 9,11,16,18,20,23,40,43,46,48,50-51,53,112,124,130,392-393,426-427
 Terminal Pliers 356,425
 Thread Chaser 425-426
 Thread Insert 425

Speeder Handles

3/8" Drive 21,23,131
 1/2" Drive 167

Spindle Nut

Set 391,451
 Socket 391,451-452
 Wrench 391,451-452

Spindle Puller 391,450-451

Split Bearing Attachment 480

Square Drive Oil Filter Wrench 457

Steering Service Set 390,463

Steering Wheel

Lock Plate Remover 390,463
 Puller Legs 390,463

Stethoscope 396,476

Straight Hose Clamp Pliers 357,397

Stud Extractor 455

Stud Removal

Set 393,453
 Sockets 393,453-454

Swivoil Filter Wrench 455

T

Tachometer, Hand Held 399,476

Tap and Die 365-369

Tap and Die

Ratcheting Wrench 365-369
 Sets 365-367

Tape Measures 10,16-17,20,23,500

Tape Measures

Power Return Tapes 500
 Power Return Tapes
 Power Tapes 500

Technical Education Sets

Auto 9,13,15-16
 Auto Body 17-18
 Aviation 21,23
 Diesel 12,19-20
 HVAC 14
 Starter Set 10-11

T-Handles, Chrome 166,176-177

T-Handles, Chrome

1/2" Drive 166
 3/4" Drive 176-177

T-Handles

ALLEN® Hex 489-490

Thermal Sensor 392,405-406

Thread Chaser

Spark Plug 425

Thread Restorer Files 369

Tie Rod End Puller and Pitman Arm Puller 390,464,466

Tie Rod Separator 390,464-466

Tire Tread and Brake Lining Gauge 447

Tool Holder Magnetic 34

Tool Sets, Mechanics 38-53,66-74,100-111,147-155,176,179-181

Tool Storage

Cabinets
 TEP Series 31-32
 XL Series 27-29
 Carts
 XL Series 29-30
 Chests
 TEP Series 30-32
 XL Series 27-28
 Hand Boxes & Bags 21,33

Torque Wrenches 315-318

Torque Wrenches

Deflecting Beam 317
 Electronic 317-318
 Micrometer Adjustable 315-316

Truck and Tractor Oil Filter Wrench 457

Tubing Bender 14,394,443,445

Tubing Cutter 14,394,396,443,445

Tubing Service Set 394,443

U

Universal Joints

Hand, Chrome
 1/4" Drive 11,16,18,20-21,23,58-59,66-71,87
 3/8" Drive 9,11,16,18,20-21,23,58-59,100-106,129
 1/2" Drive 11,16,18,20,59,147-151,154,166-167
 Impact
 1/4" Drive 58,192,198
 3/8" Drive 58,207
 1/2" Drive 58,218

Universal Sockets / Flex Sockets

Hand 23,66,81,95,118,138
 Hand
 Sets 81,118
 Impact
 191-192,196-197,200-201,206,211,217,224-225
 Impact
 Sets 196-197,206,217
 1/4" Drive 191-192,196-197,200-201
 3/8" Drive 206,211
 1/2" Drive 217,224-225

Utility Knives 9-10,16-17,20,23,502

Utility Knives

Auto-Retracting 502
 Quick-Change 502
 Utility Blades 502

V

Valve Grinder 416

Valve Spring Compressor 416-417

Vibro Engraver 482

Vinyl Rolls 14

Voltage Tester 422

Vortex™

Sockets 179-187

W

Wheel Weight Tool 453

Window Molding Remover 13,17,434

Wobble Extensions

1/4" Drive 49,88-89
 3/8" Drive 132
 1/2" Drive 49,168

Wrenches.....
9-12,14,16,18,20-21,23,38,41,44,47,49,51,119-120,139-140,232-312,496

Wrenches

- Adjustable 12,14,23,312,496
- Box 309-310
- Crowfoot.....120,140,307-309
- Double Box Ratcheting 269-271
- E-Torx® Ratcheting.....285
- Flare Nut.....12,14,302-305
- Flex Combination Ratcheting 262-266
- Half-Moon Double Box Ratcheting 282-283
- Indexing Ratcheting 274-276
- Open End Ratcheting 276-278
- Pipe 14
- Ratcheting . 14,119,139,232-286,301-302,305-307
- Ratcheting
 - Box 281-282,285
 - Combination 238-250
 - Combination, Reversible 253-259,286
 - Flare Nut..... 301-302
 - GearBox™ Double Box 269-271
 - QuadBox™ Double Box..... 14,278-280
 - S-Shape Double Box 283-284
 - Stubby Combination..... 251-252,263
- Stubby Flex Combination Ratcheting 267-268
- Torque 315-318
- XL Combination Ratcheting 238-242
- XL GearBox™ Double Box Ratcheting 269-273
- XL Locking Flex Combination Ratcheting... 259-262
- XL Spline Combination Wrenches273-274
- XL X-Beam™ Ratcheting..... 232-237

Z

Zerk Fitting Tool.....**401,468**

1000DDD	470	122060GR	179,183	1347D	470	222273	440
1001D	470	122070GR	179,183	1348D	470	222276	440
1002D	470	122080GR	179,183	1349D	470	2223D	473
1003DD	470	122090GR	179,183	1350	470	2228D	369
1004D	470	122100GR	179,183	1351D	470	2229D	369
1005D	470	122120GR	179,183	1352D	470	2249D	369
1006D	470	122140GR	179,183	1353D	470	2270	399
1007D	470	122160GR	179,183	1354D	470	2274D	472
1008D	470	122180GR	179,183	135D	356,425	2282D	10,16,20-21,23,337
1009D	470	124DD	398	142200GR	181,185	2283	16,20-21,23,337
1010D	470	12675	422	142220GR	181,185	2284D	414
1011D	470	12678	422	142240GR	181,185	228675	412
1012D	470	126D	422	142260GR	181,185	228677	412
1013D	470	129D	9-10,15,17,19,422	142280GR	181,185	2286D	412
1014D	470	1300D	470	142300GR	181,185	2287D	465
1015D	470	1301D	470	142320GR	181,185	2288D	465
1016D	470	1302D	470	142340GR	181,185	2289D	390,464,466
1017D	470	1303D	470	142360GR	181,185	229070	434
1018D	470	1304D	470	142380GR	181,185	229076	434
1019D	470	1305D	470	14273D	494	2290D	434
1020D	470	1306D	470	145	357,397	2291D	390,463
1021D	470	1307D	470	161D	472	230071D	392,480
1022D	470	1308D	470	162D	9-10,15,19,23,472	230075D	392,480
1023D	470	1309D	470	163D	473	2304D	401
1024D	470	1310D	470	164	473	2305D	401
1025D	470	1311D	470	166D	473	2306D	401
1026D	470	1312D	470	1708DD	455	2309D	23,419
1027D	470	1313D	470	1711D	477	231060GR	180,188
1028D	470	1314D	470	1715D	359	231061GR	179,187
1029D	470	1315D	470	172271	414	231062GR	180,187
1030D	470	1316D	470	1722D	414	231080GR	180,188
1031D	470	1317D	470	1723D	413	2310D	419
1032D	470	1318D	470	1724	414	2311D	13,17,419
1033	470	1319D	470	190	456	2312DD	418
1034D	470	1320D	470	191	456	2314D	419
1035D	470	132120GR	180,184	192	456	2320D	12,460
1036D	470	132140GR	180,184	2004D	446	2320W	459
1037D	470	132160GR	180,184	2010D	457	2321	12,460
1038D	470	132180GR	180,184	2012D	358	2321W	459
1039D	470	1321D	470	201D	421	2322D	12,460
104	424	132200GR	180,184	2029DD	457	2322W	459
1040D	470	132220GR	180,184	202D	420	2324D	447
1041D	470	132240GR	180,184	203182D	418	2326D	447
1042D	470	132260GR	180,184	2031DD	418	235080GR	462
1043D	470	132280GR	180,184	2037DD	434	238978	414
1044D	470	1322D	470	2038D	13,17,434	2389D	414
1045D	470	1323D	470	203D	356,420	2391	21,23,477
1046	470	1324D	470	204D	420	2398D	468
10473	424	1325DD	470	205D	421	241062GR	181,187
1047D	470	1326D	470	2062D	472	241080GR	181,188
1048	470	1327D	470	206D	421	2419D	370
1049D	470	1328D	470	2071D	418	242	419
1050D	470	1329D	470	2078D	417	2420D	468
1051DD	470	1330	470	2106	13,17,435	2423D	424
1109D	370	1331D	470	2107D	14,394,396,443,445	2425D	13,17,21,23,401
1110D	370	1332D	470	2109D	10	2426D	13,17,401
1111D	370	1333D	470	2116D	447	242875	399
1112D	370	1334D	470	2123D	426	2428D	399
1113DD	370	1335D	470	2125D	425	2467	391,451
1114D	413	1336D	470	2126D	425	2486	415
1119D	413	1337	470	2127D	425	2487D	415
1120D	413	1338D	470	2128D	425	2488D	415
1121D	413	1339D	470	2129DD	425	2489D	415
1122D	413	1340D	470	2153D	424	2490D	415
1123D	413	1341D	470	2162D	14-15,17,19,21,23,356,424	2491	415
1124D	413	1342D	470	2173DD	421	2492	415
1125D	413	1343D	470	2187D	456	2493DD	415
1140D	369,454,482	1344D	470	2189D	14,394,443,445	2517D	445
11-935	21,23	1345D	470	221060GR	179,188	2520	482
122050GR	179,183	1346D	470	221080GR	179,188	2521D	405

2522D.....	475	31037D.....	493	3488D.....	361	367985.....	412
2524D.....	423	31038D.....	493	3489.....	361	3680D.....	407
2527D.....	475	31052D.....	493	3490D.....	361	3681D.....	407
2534D.....	358	310901GR.....	332-334	3491.....	361	3684D.....	408
2538D.....	439	310902GR.....	332-334	3492.....	361	3685D.....	494
2550D.....	469	310903GR.....	333-334	3493.....	361	3686D.....	494
2554D.....	481	311901GR.....	332-334	3494.....	361	3702D.....	432
2593.....	15,17,19,21,23,477	311902GR.....	332-334	3495.....	361	3703D.....	432-433
2595D.....	460	311903GR.....	333-334	3498.....	315	3704D.....	432-433
2646D.....	422	311904GR.....	333-334	3508D.....	459	3705.....	431-432
2647D.....	422	3121D.....	481	350971.....	463	3718D.....	13,17
2649D.....	423	312901GD.....	334	350972.....	463	3719.....	13,17
265D.....	446	31430.....	394,411	3509D.....	390,463	3720.....	13,17
266.....	446	3149.....	460	3510D.....	390,463	3722.....	13,17
2756D.....	423	3150D.....	362	3525D.....	388,436,439	3723.....	13
2757D.....	423	3151.....	15,17,23,362	3526D.....	405	3724.....	13,17
2761D.....	434	315177.....	353	3527.....	455	3725.....	13,17
2770D.....	391,451	3152D.....	362	352870.....	435	3729.....	13,17,431-432
2774D.....	15,388,436,438	3155D.....	34	3528D.....	435	3737D.....	439
2775D.....	453	3157.....	415	3529D.....	461	3738.....	439
2790D.....	458	3161D.....	391,450	3530D.....	402	3739.....	439
280.....	437	3162D.....	391,450	3551D.....	479	3756D.....	448,474
2822D.....	13,17,433	3163D.....	15,388,436,438	3552.....	479	3761.....	448,475
2824D.....	469	3191D.....	467	3553D.....	479	3763.....	449,475
2833D.....	414	3195D.....	391,451-452	3561.....	479	3766.....	475
2834D.....	415	3245.....	411,469	3562D.....	479	3774D.....	449,474
2835D.....	415	3246D.....	451	3563.....	479	3777.....	449,474
2836DD.....	415	3253D.....	458	3591D.....	392,480	3787.....	441
2840D.....	15,17,19,21,23,476	3261D.....	315	3605.....	494	3788.....	441
285D.....	437	3270D.....	391,450	362401.....	478	3789.....	442
287D.....	388,436,438	327175D.....	417	362402.....	478	3790D.....	442
289780.....	410	327176.....	417	362403.....	478	3791.....	358,396
289781.....	410	3271DD.....	417	3624D.....	477-478	3792D.....	358,397
289782.....	410	3288D.....	460	3625.....	477-478	3793.....	358,397
289783.....	410	3289.....	400	362501.....	478	37951.....	441
289784.....	410	3290D.....	401-402	362502.....	478	37952.....	441
289785.....	410	3293D.....	474	362503.....	478	3795D.....	440
289786.....	410	3312D.....	466	3626.....	479	3796.....	442
289787.....	410	3321.....	388,401-403	362601.....	479	379D.....	416
289788.....	410	3324D.....	455	362602.....	479	380.....	416
289789.....	410	3343D.....	400	362603.....	479	38370D.....	417
289790.....	410	3355D.....	388,436,438	3627.....	477	383D.....	417
2897D.....	410	3358.....	453	362801.....	478	38570D.....	417
290101.....	440	335804.....	453	3628D.....	478	3859D.....	360
290171.....	440	3367.....	420	3637.....	494	385D.....	417
2901D.....	440	3368.....	459	3639.....	494	3860D.....	457-458
29-426.....	14	3368F.....	459	3641.....	494	3861D.....	457-458
2955D.....	317	3369.....	459	3643.....	494	3862D.....	457-458
2956D.....	317	3369F.....	459	3649D.....	494	3863.....	457-458
2957D.....	317	3376D.....	438	3651D.....	494	3864D.....	457-458
295D.....	15,437	3377.....	448	3653.....	494	3865.....	457
2967.....	399,476	3379D.....	426	3655DD.....	494	3870D.....	462
2968D.....	476	3387.....	467	3657.....	494	3871D.....	462
2979.....	17,21,23,482	3390.....	435	3659D.....	494	3872D.....	462
298D.....	15,388,436-437	3408D.....	388,402-403	3664.....	494	3873D.....	462
2991D.....	458	3413D.....	388,403,468	3666.....	494	3874D.....	462
2992D.....	400	3414D.....	407	36790D.....	412	3875D.....	462
30052D.....	494	3422.....	389,408-409	367971.....	412	3876D.....	462
30243D.....	493	3449D.....	391,450	367972.....	412	3877D.....	462
30246D.....	493	345071.....	467	367973.....	412	3880.....	368
30247D.....	493	3450D.....	467	367974.....	412	3881.....	365-368
30248D.....	494	3457.....	14	367975.....	412	3882.....	365-368
3029.....	446	3468.....	399	367976.....	412	3883.....	365-368
302975.....	446	3472.....	408	367977.....	412	3884D.....	365-369
30354.....	493	3473.....	389,408-409	367978.....	412	3885.....	367
30598.....	493	3483DD.....	361	367980.....	412	3886.....	367
30602.....	493	3484D.....	361	367981.....	412	3887.....	366
30827D.....	494	3485D.....	361	367982.....	412	3888D.....	431-432
3082D.....	455	3486.....	361	367983.....	412	3890D.....	388,403
3083D.....	455	3487.....	361	367984.....	412	3891D.....	388,403

3892D.....	388,403	41549D.....	389,436	448DD.....	360	57116.....	486
3893D.....	388-389,403-404,410	41550D.....	389,436	457.....	359	57118.....	486
3894.....	388,403-404	41560D.....	389,410	492.....	398	57120.....	486
3895D.....	388,403-404	41561D.....	389,410	501D.....	416	57122.....	486
3896D.....	388,403-404	41562D.....	389,410	505D.....	416	57124.....	486
3897D.....	388,403-404	41580D.....	389,408	522040GR.....	179,183	57126.....	486
3898D.....	388,403-404	41590D.....	394,443	522050GR.....	179,183	57128.....	486
3900.....	389,408	41592.....	396,443	522060GR.....	179,183	57130.....	486
3901D.....	389,408	41593.....	396,443	522070GR.....	179,183	57132.....	486
3902D.....	389,408	41594.....	14,394-395,443-444	522080GR.....	179,183	61059.....	401
3905D.....	14,394-396,443-445	41595.....	14,394-395,443-444	522090GR.....	179,183	66-808.....	14
3906D.....	390,463-464	41596.....	14,394,443	522100GR.....	179,183	66-809.....	14
3907D.....	391,450	41597.....	395-396,443-444	522110GR.....	179,183	66-810.....	14
3908D.....	391,450	41598D.....	395,444	522120GR.....	179,183	66-811.....	14
3909D.....	391,450	41599.....	395-396,443-444	522130GR.....	179,183	66-812.....	14
3910D.....	391,450-451	41600.....	390,412	522350GR.....	179,183	66-814.....	14
3911D.....	391,451	41601.....	390,412	522450GR.....	179,183	66-816.....	14
3912D.....	451	41602.....	390,412	522550GR.....	179,183	69-350.....	14
3916D.....	390,464,466	41603.....	390,412	532100GR.....	180,184	71573D.....	371,454,482
3917D.....	390,464,466	41604D.....	390,412	532110GR.....	180,184	71574.....	371,454,482
3919D.....	392,405	41605.....	390,412	532120GR.....	180,184	71575D.....	371,454,482
3920D.....	392,405-406	41620D.....	390,463	532130GR.....	180,184	715D.....	371,454,482
3921D.....	392,405-406	41630D.....	391,452	532140GR.....	180,184	720DD.....	370
3922D.....	392,405-406	41631D.....	391,452	532150GR.....	180,184	73-014.....	14
3923D.....	392,405-406	41632.....	391,452	532160GR.....	180,184	730D.....	425
3924D.....	392,405-406	41633.....	391,452	532170GR.....	180,184	80000.....	10,16-17,20,321,323,326
3925D.....	392,405,407	41634.....	391,452	532180GR.....	180,184	80001.....	
3926D.....	407	41635.....	391,452	532190GR.....	180,184	9-10,16-17,20-21,23,321-323,326	
3927D.....	393,427	41636D.....	391,452	542150GR.....	181,185	80004.....	10,16-17,20,321,326
3928D.....	392-393,426-427	41637.....	391,452	542160GR.....	181,185	80005.....	10,16-17,20,321,326
3929D.....	393,427	41638.....	391,452	542170GR.....	181,185	80006.....	323,326
3930D.....	392,426-427	41639.....	391,452	542180GR.....	181,185	80007.....	
3931D.....	392,426-427	41640.....	391,452	542190GR.....	181,185	9-10,16-17,20-21,23,321-323,326	
3932D.....	394,461	41650.....	391,450	542200GR.....	181,185	80009.....	326
3933D.....	394,461	41660D.....	391,451	542210GR.....	181,185	80010D.....	323,326
3934D.....	394,461	41680D.....	396,435	542220GR.....	181,185	80011.....	10,16,18,20,321,323,326
3935.....	394,461	41690.....	390,464	542240GR.....	181,185	80012D.....	10,16,18,20,321,325
3936.....	394,461	416D.....	401,468	542270GR.....	181,185	80013.....	
3937.....	391,451-452	41700D.....	392,480	542300GR.....	181,185	9-10,16,18,20-21,23,321-323,325	
3938D.....	427	41704.....	392,480	542320GR.....	181,185	80014.....	10,16,18,20,321,323,325
3939D.....	394,461	41705.....	392,480	56008D.....	486	80015.....	9,21,23,322-323,325
3941.....	455	41706.....	392,480	56015D.....	486	80017.....	322,325
3942.....	455	41707.....	392,480	56080.....	486	80018D.....	10,16,18,20,321,325
3943.....	455	41708.....	392,480	56603G.....	9,16,18,20,38,41,44,47,51,487	80019D.....	323,325
3944.....	455	41710.....	392,480	56606G.....	38,41,44,487	80020D.....	323,325
3950.....	409	41720.....	392,405	56609G.....	487	80021.....	323,325
3955.....	467	41730D.....	392,426	56612G.....	10,23,488	80022.....	
3962.....	388,436,447	41740D.....	393,427	56615G.....	10,16,20,488	9-10,16,18,20-21,23,321-323,325	
3970D.....	409	41760D.....	393,453	56618G.....	488	80023.....	
3975D.....	357,397	41761.....	393,453-454	56622G.....	485	9-10,16,18,20-21,23,321-323,325	
3976D.....	357,397	41762D.....	393,453-454	56624G.....	485	80024D.....	324,326
3977.....	357,398	41763D.....	393,453-454	56626G.....	485	80025.....	321,324,326
3978D.....	357,398	41764.....	393,453-454	56634G.....	485	80026D.....	321,324,326
3990.....	465	41765.....	393,453-454	56650G.....	489	80027.....	324,326
3991.....	465	41766.....	393,453-454	56652G.....	490	80028D.....	324,326
412402.....	369,454,482	41767D.....	393,453-454	56656G.....	489	80029.....	324,326
412403.....	369,454,482	41768D.....	393,453-454	56660G.....	489	80030D.....	324
412406.....	369,454,482	41780D.....	393,411	57006.....	486	80031.....	321,327-329,344
412410.....	369,454,482	41830.....	394,461	57008D.....	486	80032.....	321,327-329,344
41500.....	388,403	41840D.....	431	57010.....	486	80033.....	321,327-329,344
41520.....	388,436	41850.....	431	57012.....	486	80034.....	321,327-328,344
41540.....	389,436	41860.....	395,444	57013D.....	486	80035.....	321,327-328,344
41541.....	389,436	41870.....	395,444	57014D.....	486	80036.....	321,327-328,344
41542.....	389,436	41880D.....	396,443	57018.....	486	80037.....	327-329
41543.....	389,436	41890.....	394,461	57020D.....	486	80038.....	327-329
41544.....	389,436	431D.....	13,17,433	57022.....	486	80039.....	327-329
41545.....	389,436	43990.....	464	57024.....	486	80040.....	327-329
41546D.....	389,436	445.....	359	57026D.....	486	80041.....	327-329
41547.....	389,436	446D.....	359	57028.....	486	80042D.....	327-329
41548D.....	389,436	447.....	360	57030D.....	486	80043.....	322,324,327

80044	322,324,327	80115	11,16,18,39,41,44,52,67-68,70,72,75,77,93	80139	11,16,18,39,42,45,66-68,75,80,94	80187	18,61-64,98
80045	322,324,327	80115S	76,92	80139S	79,92	80188D	18,61-64,98
80046	322,324,327	80116D	11,16,18,39,41,44,52,67-68,70,72,75,77,93	80140	11,16,18,66-68,75,80,94	80189	18,61-64,98
80047	331,355	80116S	76,92	80140S	79,92	80190	18,61-64,98
80048	331,355	80117	11,16,18,39,41,44,47,49,52,67-68,70,72,75,77,93	80141	11,16,18,39,42,45,52,66-68,73,75,80,94	80191	66,82,99
80049	331,355	80117S	76,92	80141S	79,92	80192	66,82,99
80050	322	80118	11,16,18,39,41,44,47,49,52,67-68,70,72,75,77,93	80142	11,16,18,39,42,45,47,49,52,66-68,73,75,80,94	80193	66,82,99
80051	321	80118S	76,92	80142S	79,92	80194	66,82,99
80052	323	80119	11,16,18,39,41,44,47,49,52,67-68,70,72,75,77,93	80143	11,16,18,39,42,45,47,49,52,66-68,73,75,80,94	80195	66,82,99
80053	323	80119S	76,92	80143S	79,92	80196	66,82,99
80054	324	80120D	11,16,18,39,41,44,47,49,52,67-68,70,72,75,77,93	80144	11,16,18,39,42,45,47,49,52,66-68,73,75,80,94	80197	52,69,73,79,91
80055	328	80120S	76,92	80144S	79,92	80198	52,69,73,79,91
80056	328	80121	11,16,18,39,41,44,47,49,52,67-68,70,72,75,77,93	80145	11,16,18,39,42,45,47,49,52,66-68,73,75,80,94	80199	69,79,91
80057	327	80121S	76,92	80145S	79,92	80200	52,69,73,79,91
80058	344	80122D	11,16,18,39,41,44,47,49,52,67-68,70,72,75,77,93	80146D	11,16,18,39,42,45,47,49,52,66-68,73,75,80,94	80201	52,69,73,79,91
80059	323	80122S	76,92	80146S	79,92	80202	52,69,73,79,91
80060	322	80123	11,16,18,39,41,44,47,49,52,67-68,70,72,75,77,93	80147	11,16,18,39,42,45,47,49,52,66-68,73,75,80,94	80203	52,69,73,79,91
80061	324	80123S	76,92	80147S	79,92	80204	52,69,73,79,91
80062	355	80124	11,16,18,39,41,44,67-68,70,75,77,93	80148	11,16,18,39,42,45,47,50,52,66-68,73,75,80,94	80205	52,69,73,79,91
80063	331	80124S	76,92	80148S	79,92	80206	52,69,73,79,91
80064	324	80125	9,11,16,18,20,39,41,44,47,49,51,53,66-68,74-75,78,91	80149	11,16,18,39,42,45,52,66-68,73,75,80,94	80207	69,79,91
80065	325	80125S	76,92	80149S	79,92	80208	69,79,91
80066	321	80126	9,11,16,18,20,39,41,44,47,49,51,53,66-68,74-75,78,91	80150	11,16,18,66-68,75,80,94	80209	69,79,91
80072	337	80126S	76,92	80150S	79,92	80210	21,23,39,50,52,69,71-72,77,90
80080	331	80127	9,11,16,18,20,39,41,44,47,49,51,53,66-68,74-75,78,91	80151D	81,96	80211	21,23,39,50,52,69,71-72,77,90
80081	331,355	80127S	76,92	80152	81,96	80212	21,23,39,50,52,69,71-72,77,90
80082	331,355	80128	9,11,16,18,20,39,41,44,47,51,53,66-68,75,78,91	80153	81,96	80213	21,23,39,50,52,69,71-72,77,90
80083	331	80128S	76,92	80154	81,96	80214	21,23,39,50,52,69,71-72,77,90
80084	332,355	80129	9,11,16,18,20,39,41,45,47,49,51,53,66-68,74-75,78,91	80155	81,96	80215D	21,23,39,50,52,69,71-72,77,90
80085D	332,355	80129S	76,92	80156	81,96	80216	21,23,39,50,52,69,71-72,77,90
80086	324,326	80130	9,11,16,18,20,39,41,44,47,49,51,53,66-68,74-75,78,91	80157	81,96	80217	21,23,39,50,52,69,71-72,77,90
80087	324,326	80130S	76,92	80158	81,96	80218	21,23,39,50,52,69,71-72,77,90
80088	324,326	80131D	9,11,16,18,20,39,42,45,47,49,51,53,66-68,74-75,78,91	80159	81,96	80219	21,23,39,69,71,77,90
80089	325,327	80131D	9,11,16,18,20,39,42,45,47,49,51,53,66-68,74-75,78,91	80160	81,96	80220	21,23,69,71,78,93
80090	325,327	80132	9,11,16,18,20,39,42,45,47,49,51,53,66-68,74-75,78,91	80161	82,96	80221	21,23,69,71,78,93
80091	325,327	80132S	76,92	80162	82,96	80222	21,23,69,71,78,93
80092	325,327	80133	9,11,16,18,20,39,42,45,47,49,51,66-68,74-75,78,91	80163	82,96	80223D	21,23,69,71,78,93
80100	11,16,18,20-21,23,58,66-71,87	80133S	76,92	80164	82,96	80224	21,23,69,71,78,93
80101	58,192,198	80134	9,11,16,18,20,39,42,45,47,49,51,66-68,74-75,78,91	80165	82,96	80225	21,23,69,71,78,93
80104D	38,41,47,51,53,70,75,90	80134S	76,92	80166	82,96	80226	21,23,69,71,78,93
80105	9,11,16,18,20,38,41,44,47,49,51,53,67-68,70,74-76,90	80135D	9,11,16,18,20,39,42,45,47,49,51,66-68,74-75,78,91	80167	66,82,96	80227	21,23,69,71,78,93
80106	9,11,16,18,20,38,41,44,47,49,51,53,67-68,70,74-76,90	80135D	9,11,16,18,20,39,42,45,47,49,51,66-68,74-75,78,91	80168	66,82,96	80228	21,23,69,71,78,93
80107	9,11,16,18,20,38,41,44,47,49,51,53,67-68,70,74-76,90	80136	9,11,16,18,20,39,42,45,51,66-68,75,78,91	80169	66,82,96	80229	21,23,69,71,78,93
80108	9,11,16,18,20,38,41,44,47,49,51,53,67-68,70,74-76,90	80137	9,11,16,18,20,39,42,45,66-68,75,78,91	80170D	66,82,96	80230	69,80,94
80109	9,11,16,18,20,39,41,44,47,49,51,53,67-68,70,74-76,90	80137	9,11,16,18,20,39,42,45,66-68,75,78,91	80171	13,16,20,62,97	80231	69,80,94
80110	9,11,16,18,20,39,41,44,47,49,51,53,67-68,70,74-76,90	80138	11,16,18,39,42,45,66-68,75,80,94	80172	13,16,18,20,61-62,64,97	80232	69,80,94
80111	9,11,16,18,20,39,41,44,47,49,51,53,67-68,70,74-76,90	80138S	79,92	80173	13,16,18,20,61-62,64,97	80233	69,80,94
80112	9,11,16,18,20,39,41,44,47,49,51,53,67-68,70,74-76,90			80174	13,16,18,20,61-62,64,97	80234	69,80,94
80113D	9,11,16,18,20,39,41,44,47,49,51,53,67-68,70,74-76,90			80175	13,16,18,20,61-62,64,97	80235	69,80,94
80114D	9,11,16,18,20,39,41,44,49,51,53,67-68,70,75-76,90			80176D	13,16,18,20,61-62,64,97	80236	69,80,94
				80177D	13,16,18,20,61-62,64,97	80237	69,80,94
				80178	49,62-63,97	80238	69,80,94
				80179	49,62-63,97	80239D	69,80,94
				80180	49,62-63,97	80240	69,80,94
				80181	49,62-63,97	80241	69,80,94
				80182	49,62-63,97	80242	69,80,94
				80183	62-63,97	80243	66,99
				80184	62-63,97	80250	66,81,95
				80185	62-63,97	80251D	66,81,95
				80186	62-64,98	80252	66,81,95
						80253	66,81,95
						80254	66,81,95
						80255	66,81,95
						80256	66,81,95
						80257	66,81,95
						80258	66,81,95
						80259	66,81,95
						80260	66,81,95
						80261	66,81,95
						80262	23,81,95

80263D.....	23,81,95	9,11,16,18,20,39,42,45,47,53,100,102-103,105,109,111-113,133	100,102,108,110,112,115,134	80411.....	121,141
80264.....	23,81,95	80356.....	803799,11,16,18,20,39,42,45,48,50,53,100,102,108,110,112,115,134	80412D.....	121,141
80265.....	23,81,95	9,11,16,18,20,39,42,45,47,53,100,102-103,105,109,111-113,133	803809,11,16,18,20,39,42,45,48,50,53,100,102,108,110,112,115,134	80413.....	121,141
80266.....	23,81,95	80357.....	803819,11,16,18,20,39,42,45,48,50,53,100,102,108,110,112,115,134	80414.....	65,103-104,121,141
80267.....	23,81,95	9,11,16,18,20,39,42,45,47,53,100,102-103,105,109,111-113,133	803829,11,16,18,20,39,42,45,48,50,53,100,102,108,110,112,115,134	80415D.....	121,141
80268.....	23,81,95	80358.....	803839,11,16,18,20,39,42,45,48,50,53,100,102,108,110,112,115,134	80416.....	18,61,65,103-104,121,141
80290.....	71,90	9,11,16,18,20,100,102-103,105,109,112-113,133	80384 9,11,16,18,20,39,42,45,48,100,102,108,110,112,115,134	80417.....	18,61,65,103-104,121,141
80300.....	68	80362.....	80385 9,11,16,18,20,39,42,45,48,50,100,102,108,110,112,115,134	80418.....	18,61,65,103-104,121,141
80300P.....	67	9,11,16,18,20,39,42,45,47,53,100,102-103,105,109,111-113,133	80386 9,11,16,18,20,39,42,45,48,100,102,108,112,115,134	80419.....	18,61,65,103-104,121,123,141,388,436
80301.....	69	80363.....	80387 9,11,16,18,20,39,42,45,48,50,100,102,108,112,115,134	80420.....	18,61,65,103-104,121,141
80302D.....	78	11,16,18,20,100,102-103,105,109,112-113,133	80388 11,16,18,20,100,102,112,117,137	80421.....	18,61,65,103-104,121,123,141,388,436
80303.....	76	80364.....	80388S.....	116,135	
80304.....	80	103,105,112,114,136	80389 11,16,18,20,100,102,112,117,137	80422.....	18,61,121,141
80304S.....	79	80365.....	80389S.....	116,135	
80305.....	77	11,16,18,20,39,42,45,48,52,100,102-103,105,108,112,114,136	80390 11,16,18,20,100,102,112,117,137	80423.....	18,61,121,141
80305S.....	76	80366.....	80390S.....	116,135	
80306.....	79	11,16,18,20,39,42,45,48,52,100,102-103,105,108,112,114,136	80391 11,16,18,20,39,42,45,100,102,112,117,137	80424.....	18,61,121,141
80307D.....	77	80367.....	80391S.....	116,135	
80308.....	80	11,16,18,20,39,42,45,48,52,100,102-103,105,108,112,114,136	80392 11,16,18,20,39,42,45,48,50,100,102,107,112,117,137	80425.....	18,61,65,121,141
80309D.....	78	80368.....	80392S.....	116,135	
80310D.....	81	11,16,18,20,39,42,45,48,52,100,102-103,105,108,112,114,136	80393D 11,16,18,20,39,42,45,48,100,102,107,112,117,137	80426.....	18,61,65,121,141
80311.....	81	80369.....	80393S.....	116,135	
80312DD.....	70	11,16,18,20,39,42,45,48,52,100,102-103,105,108,112,114,136	80394D 11,16,18,20,39,42,45,48,50,100,102,107,112,117,137	80427.....	18,61,65,121,141
80313.....	71	80370.....	80394S.....	116,135	
80314D.....	75	11,16,18,20,39,42,45,48,52,100,102-103,105,108,112,114,136	80395 11,16,18,20,39,42,45,48,50,100,102,107,112,117,137	80428D.....	18,61,65,121,141,388,436
80315.....	66	80371.....	80395S.....	116,135	
80320.....	82	11,16,18,20,39,42,45,48,52,100,102-103,105,108,112,114,136	80396 11,16,18,20,39,42,45,48,50,100,102,107,112,117,137	80429.....	18,61,65,121,123,141,388,436
80321.....	82	80372.....	80396S.....	116,135	
80322.....	81	11,16,18,20,39,42,45,48,52,100,102-103,105,108,112,114,136	80397 11,16,18,20,39,42,45,48,50,100,102,107,112,117,137	80430.....	18,61,65,121,141
80323.....	82	80373.....	80397S.....	116,135	
80324.....	74	11,16,18,20,39,42,45,48,52,100,102-103,105,108,112,114,136	80398 11,16,18,20,39,42,45,48,50,100,102,107,112,117,137	80431.....	18,61,65,121,141,388,436
80325.....	72	80374.....	80398S.....	116,135	
80326.....	74	11,16,18,20,39,42,45,48,52,100,102-103,105,108,112,114,136	80399 11,16,18,20,39,42,45,48,50,100,102,107,112,117,137	80432.....	121,141
80327.....	73	80375.....	80399S.....	116,135	
80330.....	39,42,45,108,112,134	11,16,18,20,39,42,45,48,52,100,102-103,105,108,112,114,136	80400 11,16,18,20,39,42,45,48,100,102,107,112,117,137	80433.....	121,141
80331.....	39,42,45,108,112,134	80376.....	80400S.....	116,135	
80332.....	39,42,45,108,112,134	11,16,18,20,39,42,45,48,52,100,102-103,105,108,112,114,136	80401 11,16,18,20,39,42,45,48,100,102,112,117,137	80434.....	122,143
80333.....	118,138	80377.....	80401S.....	116,135	
80334.....	118,138	11,16,18,20,39,42,45,48,52,100,102-103,105,108,112,114,136	80402.....	123,146	
80335.....	118,138	80378.....	9,11,16,18,20,23,40,43,46,48,50-51,53,112,130	80465.....	123,146
80336.....	118,138	11,16,18,20,39,42,45,48,52,100,102-103,105,108,112,114,136	804039,11,16,18,20,23,40,43,46,112,130	80466.....	123,146
80337.....	118,138	80379.....	80404.....	130	
80338.....	118,138	11,16,18,20,39,42,45,48,52,100,102-103,105,108,112,114,136	80405.....	130	
80339.....	118,138	80380.....	80406.....	112,137	
80340.....	118,138	11,16,18,20,39,42,45,48,52,100,102-103,105,108,112,114,136	80407.....	112,137	
80341.....	118,138	80381.....	80408.....	112,137	
80342.....	118,138	11,16,18,20,39,42,45,48,52,100,102-103,105,108,112,114,136	80409.....	112,137	
80343.....	118,138	80382.....	80410.....	121,141	
80344.....	118,138	11,16,18,20,39,42,45,48,52,100,102-103,105,108,112,114,136			
80345.....	118,138	80383.....			
80346.....	118,138	11,16,18,20,39,42,45,48,52,100,102-103,105,108,112,114,136			
80347.....	118,138	80384.....			
80348.....	118,138	11,16,18,20,39,42,45,48,52,100,102-103,105,108,112,114,136			
80349.....	118,138	80385.....			
80350.....		11,16,18,20,39,42,45,53,100,102-103,105,109,112-113,133			
9,11,16,18,20,39,42,45,53,100,102-103,105,109,112-113,133		80351.....			
80351.....		9,11,16,18,20,39,42,45,53,100,102-103,105,109,112-113,133			
9,11,16,18,20,39,42,45,53,100,102-103,105,109,112-113,133		80352.....			
80352.....		9,11,16,18,20,39,42,45,47,53,100,102-103,105,109,111-113,133			
9,11,16,18,20,39,42,45,47,53,100,102-103,105,109,111-113,133		80353.....			
80353.....		9,11,16,18,20,39,42,45,47,53,100,102-103,105,109,111-113,133			
9,11,16,18,20,39,42,45,47,53,100,102-103,105,109,111-113,133		80354.....			
80354.....		9,11,16,18,20,39,42,45,47,53,100,102-103,105,109,111-113,133			
9,11,16,18,20,39,42,45,47,53,100,102-103,105,109,111-113,133		80355.....			
80355.....					

80476	49,63,99	80524	101,117,137	80593	103,105,112,136	80644	12,20,147,149,153,162,173
80477	63,146	80525	101,117,137	80594	106,136	80645	12,20,147,149,153,162,173
80478	63,146	80526	101,117,137	80595	106,136	80646D	12,20,147,149,153,162,173
80479D	63,146	80527	101,117,137	80596	40,42,45,109,134	80651	163,174
80480	41,44,47,49,51,63,99	80528	101,117,137	80597	40,42,45,109,134	80652	163,174
80481	63,145	80529	101,117,137	80598	40,42,45,109,134	80653	163,174
80482	40,101,109,116,134	80530	101,117,137	80600D	11,16,18,20,147-151,154,166	80654	65,163,174
80483	40,101,109,116,134	80531	101,117,137	80602	147,149-150,152,154-156,170	80655	65,163,174
80484	40,101,107,109,116,134	80532	101,117,137	80603	11,16,18,20,147,149-150,152,154-156,158,170	80656	65,163,174
80485	40,42,45,50-52,101,107,109,116,134	80533	101,117,137	80604	11,16,18,20,147,149-150,152,154-156,158,170	80657	163,174
80486	40,42,45,50-52,101,107,109,116,134	80534	144	80605	11,16,18,20,147,149-150,152,154-156,158,170	80658	163,174
80487	40,42,45,50-52,101,107,109,116,134	80535	144	80606	11,16,18,20,147,149-150,152,154-156,158,170	80659	163,174
80488	40,42,45,50-52,101,107,109,116,134	80536	144	80606	11,16,18,20,147,149-150,152,154-156,158,170	80660	163,174
80489	40,42,45,48,50-52,101,107,109,116,134	80537	144	80607D	11,16,18,20,147,149-150,152,154-156,158,170	80661	65,163,174
80490	40,42,45,48,50-52,101,107,109,116,134	80538	144	80608	11,16,18,20,147,149-150,152,154-156,158,170	80662	65,163,174
80491	40,42,45,48,50-52,101,107,109,116,134	80539	121,142	80609	11,16,18,20,147,149-150,152,154-156,158,170	80663	65,163,174
80492	40,42,45,48,50-52,101,107,109,116,134	80540	121,142	80610D	11,16,18,20,147,149-150,152,154-156,158,170	80664	163,174
80493	40,42,45,48,50-52,101,107,109,116,134	80541	121,142	80611	11,16,18,20,147,149-150,152,154-156,158,170	80665	65,174
80494	40,42,45,48,50-51,101,107,109,116,134	80542	121,142	80612	11,16,18,20,147,149-150,152,154-156,158,170	80666	13,16,20,62,175
80495	40,42,45,48,50-51,101,107,109,116,134	80543	121,142	80613	11,16,18,20,147,149-150,152,154-156,158,170	80667	63,175
8049621,23,40,42,45,51,101,104,106,108,110,113,133		80544	121,142	80614	12,20,147,149-150,152,156,159-160,172	80668	18,61-64,175
80497D 21,23,42,45,51,101,104,106,108,110,113,133		80545	121,142	80615	12,20,147,149-150,152,156,159-160,172	80669D	62-63,175
80498	21,23,40,42,45,48,50-52,101,104,106,108,110,113,133	80546	124,130	80616	12,20,147,149-150,152,156,159-160,172	80670	58,218
80499	21,23,40,42,45,48,50-52,101,104,106,108,110,113,133	80547	124,130	80617	12,20,147,149-150,152,156,159-160,172	80671	63,175
80500D	21,23,40,42,45,48,50-52,101,104,106,108,110,113,133	80548	58,207	80618	12,20,147,149-150,152,156,159-160,172	80672	63,175
80501	21,23,40,42,45,48,50-52,101,104,106,108,110,113,133	80549	9,11,16,18,20-21,23,58,100-106,129	80619	12,20,147,149-150,152,156,159-160,172	80673	150,156,159,172
80502	21,23,40,42,45,48,50-52,101,104,106,108,110,113,133	80550	100	80620	12,20,147,149-150,152,156,159-160,172	80674	150,156,159,172
80503	21,23,40,42,45,48,50-52,101,104,106,108,110,113,133	80550P	102	80621	12,20,147,149-150,152,156,159-160,172	80675	150,156,159,172
80504	21,23,40,42,45,48,50-52,101,104,106,108,110,113,133	80551	101	80622	147,149,155,171	80676	150,156,159,172
80505	21,23,40,42,45,48,50-52,101,104,106,108,110,113,133	80552	115	80623	147,149,155,171	80677	170
80506D	21,23,40,42,45,51-52,101,104,106,110,113,133	80553	113	80624	11,16,18,20,147,149,155,161,171	80678	150,154,156,170
80507	21,23,101,104,106,110,113,133	80554	117	80625	11,16,18,20,147,149,155,161,171	80679	150,154,156,170
80508	21,23,101,104,106,110,113,133	80554S	116	80626D	11,16,18,20,147,149,155,161,171	80680	40,43,46,151,154,158,170
80509	21,23,101,104,106,115,136	80555	114	80627	11,16,18,20,147,149,155,161,171	80681	40,157,171
80510D	21,23,50,101,104,106,115,136	80555S	114	80628	11,16,18,20,147,149,155,161,171	80682	43,46,157,171
80511	21,23,50,101,104,106,115,136	80556	111	80629	11,16,18,20,147,149,155,161,171	80683	157,172
80512	21,23,50,101,104,106,115,136	80557	108	80630	11,16,18,20,147,149,155,161,171	80684	150,159,172
80513	21,23,50,101,104,106,115,136	80558	110	80631	11,16,18,20,147,149,155,161,171	80685	150,156,159,172
80514	21,23,50,101,104,106,115,136	80559	107	80632	11,16,18,20,147,149,155,161,171	80686	150,156,159,172
80515D	21,23,50,101,104,106,115,136	80560	116	80633	11,16,18,20,147,149,155,161,171	80687	151,160,172
80516	21,23,50,101,104,106,115,136	80561	113	80634	11,16,18,20,147,149,155,161,171	80700D	147
80517	21,23,101,104,106,115,136	80562	117	80635	11,16,18,20,147,149,155,161,171	80700P	149
80518	21,23,101,104,106,115,136	80563	115	80636D	11,16,18,20,147,149,155,161,171	80701	148
80519	21,23,101,104,106,115,136	80564	118	80637	12,20,147,149,153,162,173	80702	161
80520D	101,117,137	80565	118	80638	12,20,147,149,153,162,173	80703	158
80521	101,117,137	80566	104	80639	12,20,147,149,153,162,173	80704	162
80522	101,117,137	80567	103	80640	12,20,147,149,153,162,173	80705	160
80523	101,117,137	80568	106	80641	12,20,147,149,153,162,173	80706	155
		80569	105	80642	12,20,147,149,153,162,173	80707	152
		80570	123	80643	12,20,147,149,153,162,173	80708	155
		80571	123			80709	153
		80572	65			80710D	162
		80573	122			80711	159
		80574	122			80712	163
		80577	123			80713	161
		80578	65			80714D	151
		80579	65			80715	150
		80580	121			80716	154
		80581	121			80717	154
		80582	64			80718	112
		80583	63			80720	163
		80584	110			80721	163
		80586	121			80722	64
		80587	122			80723	62
		80588	64			80724	63
		80589	109			80725	63
		80590	109			80726	61
		80591	108			80727	62
		80592	103,105,112,136			80729	156
						80730	157

80731	158	80812	40,43,46,157,171	81120	88-89	81256	59,129
80732	160	80813	43,46,157,172	81121	88-89	81257	59,167
80733	159	80814D	43,46,157,172	81122	88-89	81258	59-60,87
80745	148,153,157,171	80815D	157,172	81123	89	81259	59-60,130
80746	148,153,157,171	80817D	157,173	81124	89	81260	59-60,130
80747	148,153,157,162,171	80818	157,173	81125	89	81261	59-60,88
80748D	148,153,157,162,171	80820	157,173	81126	89	81262	59-60,131
80749	148,153,157,162,171	80822	157,173	81127	58-59,66,87	81263	59-60,168
8075040,43,46,48,148,153,157,162,171		80824	157,173	81128		81264	55,125
8075140,43,46,48,148,153,157,162,171		80826	157,173	9-10,16,18,20-21,23,41,44,49,51,70-74,86		81265	127
8075240,43,46,48,148,153,157,162,171		80827	157,173	81200D	131	81268	55
8075340,43,46,48,148,153,157,162,171		80830	176,178	81201	132	81270	128
80754		80831	176,178	81202	132	81272	132
40,43,46,48,148,153,157,162,171		80833	176,178	81203F	57	81277	51,53,58-59,66,130
80755D	40,148,153,157,162,171	80834	176,178	81204F	57	81278	58-59,130
8075640,43,46,48,148,153,157,162,171		80835D	176,178	81204P	57	81300	168
80757	40,43,46,148,153,157,162,171	80838	176,178	81205	58	81301	168
80758	40,148,153,157,162,171	80839	176,178	81206F	54	81302	169
80759	40,43,46,148,153,157,162,171	80840	176,178	81206P	56	81303F	56,165
80760	40,42,45,148,151,154,158,170	80841	176,178	81207F	56	81304F	
80761		80852	176,178	81208F	56-57,127	11,16,18,20,49,54,147-148,150-155,164	
40,42,45,148,151,154,158-159,170		80854	176,178	81209F	100-101,125	81304P	56,149,164
80762		80855D	176,178	81210F	57,128	81306F	54,165
40,42,45,148,151,154,158-159,170		80856	176,178	81210P	57,127	81306P	55,164
80763		80857	176,178	81211F	9,11,16,18,20-21,23,49,52,54,100-101,103-111,125	81307	12,16,18,20,150-151,154,166
40,42,45,148,151,154,158-159,170		80859	176,178	81211P	56,102,124	81308D	166
80764		80860	176,178	81212F	54,126	81309	38,41,44,47,56,165
40,42,45,48,148,151,154,158-159,170		80861	176,178	81212P	55,126	81310	56
80765		80862	176,178	81213F	124,128	81311	166
40,42,45,48,148,151,154,158-159,170		80863	176,178	81214F	126	81312	167
80766		80864	176,178	81215F	54,125	81339F	166
40,42,45,48,148,151,154,158-159,170		80865	176,178	81215P	55,124	81339P	166
80767		80879	176	81216F	54	81340	38,41,44,47,147-151,167
40,42,45,48,148,151,154,158-159,170		80880	176	81217	59	81341	10,16,18,20,38,147-155,167-168
80768		80929	53	81218	38,41,44,47,51,53,56,126	81342	10,20,167-168
40,42,46,48,148,151,154,158-159,170		80930	51	81219	127	81343	152-153,155,167-168
80769		80931	47-48	81221	103-104,129	81344	168
40,43,46,48,148,151,154,158-159,170		80932	44-46	81222	58	81345	49,168
80770		80933	41-43	81223	58	81346	168
40,43,46,148,151,154,158-159,170		80934	38-40	81224	58,85	81347	168
80771		80965	10,15,17,19,23	81225	58,128	81348	169
40,43,46,148,151,154,158-159,170		81002D	88	81226	58,128	81349	169
80772	50,151,160,172	81003	89	81227F	129	81350	169
80773	50,148,151,160-161,172	81004D	88	81227P	129	81354	58-59,167
80774	50,148,151,160-161,172	81007F	56-57,84	81229	124	81355	58,167
80775	50,148,151,160-161,172	81008	58,66-69,86	81230F	54	81360	165
80776	50,148,151,160-161,172	81009F	57,85	81230P	55	81361	165
80777D	50,148,151,160-161,172	81009P	57,85	81235	59	81400	176-177
80778	50,148,151,160-161,172	81011F		81236D	59	81401	176-177
80779	148,151,160-161,172	9,11,16,18,20-21,23,49,52,54,66,68-74,83		81237	60	81404	176-177
80780	148,151,160-161,172	81011P	56,67,83	81238	60	81411	176-177
80781	148,163,173	81012F	54,84	81239	131	81412	176-177
80782	148,163,173	81012P	55,83	81240	131	81413	176-177
80783	148,163,173	81013	86	81241	9-	81499	177
80784	148,163,173	81014	38,41,44,47,56,84	10,16,18,20,23,38,41,44,49,51-53,100-111,131		81603	120,140,307,309
80785	148,157,163,173	81027	86	81242	9-10,16,18,20-21,23,38,41,44,47,49,52,100-111,131	81604	120,140,307,309
80786	148,157,163,173	81028	55,84	81243	103-104,131	81605	120,140,307,309
80787	148,157,163,173	81029	84	81244	131	81606	120,140,307,309
80788	148,157,163,173	81099F	85	81245	132	81607	120,140,307,309
80789	148,157,163,173	81099P	85	81246	132	81608	120,140,307,309
80790	148,157,163,173	81101	38,52,66-69,72-74,88	81247	132	81609	120,140,307,309
80793	40,43,46,158,170	81113D		81248	132	81610	120,140,307,309
80794	40,43,46,151,154,158,170	9-10,16,18,20-21,23,38,41,44,47,70-71,88		81249	132	81611D	120,140,307,309
80795	151,160,172	81114D	88	81250	132	81612D	120,140,307,309
80796	151,160,172	81116	9-10,21,23,38,52,66-74,88	81251	132	81613	120,140,307,309
80797	151,160,172	81117D	88	81255	59,87	81614	120,140,308
80798	151,160,172	81118	88			81615	120,140,308
80805	171	81119	49,88-89			81616	120,140,308
80806	157,171					81617	120,140,308
80811	40,43,46,157,171					81618	120,140,308

81619.....	120,140,308	9,11,16,18,20,38,41,44,289-290,292-293,295	81734.....	12,289,291,293-294	81901.....	290	
81620.....	120,140,308	81668.....	81735.....	12,289,291,293-294	81902.....	292	
81621.....	120,140,308	9,11,16,18,20,38,41,44,289-290,292-293,295	81736.....	20,38,289,292,295	81903.....	298	
81622.....	120,140,308	81669.....	81737... 20,38,41,44,289,292-293,295	81741.....	12,20,289,292-293,295	81904.....	299
81623.....	120,140,308	9,11,16,18,20,38,41,44,289-290,292-293,295	81742.....	12,20,289,292-293,295	81905.....	299	
81624.....	298-300	81670.....	81743.....	12,20,289,292,294-295	81906.....	304	
81625.....	298-300	9,11,16,18,20,38,41,44,289-290,292-293,295	81744.....	12,20,289,292,294-295	81907.....	304	
81626.....	298-300	81671.....	81745D.....	12,20,289,292,294-295	81908.....	120,307	
81627.....	298-300	9,11,16,18,20,38,41,44,289-290,292-293,295	81749.....	289,293-294	81909.....	120,308	
81628.....	298-300	81672.....	81750.....	289,293-294	81910.....	302	
81629.....	298-300	9,11,16,18,20,38,41,44,289-290,292-293,295	81751.....	289,294-295	81911D.....	303	
81630.....	298-300	81673... 9,11,16,18,20,38,289-290,292-293,295	81752.....	289,294-295	81912.....	287	
81631.....	298-300	81674... 9,11,16,18,20,38,289-290,292-293,295	81753.....	289,294-295	81913.....	287	
81632.....	298-300	81675..... 9,11,16,18,20,38,49,289-290,292-293,295	81754.....	296-298	81914.....	302	
81633.....	298-300	81676..... 9,11,16,18,20,38,49,289-290,292-293,295	81755.....	296-298	81915.....	303	
81634.....	298-300	81677.....	81756.....	296-298	81916.....	292	
81635.....	298-300	9,11,16,18,20,289-290,292-293,295	81757.....	296-298	81917.....	291	
81636.....	298-300	81678.....	81758.....	296-298	81918.....	291	
81637.....	298-300	9,11,16,18,20,289-290,292-293,295	81759.....	296-298	81919.....	289	
81638.....	298-300	81679.....	81760D.....	296-298	81920.....	293	
81639.....	298-300	9,11,16,18,20,38,49,289-290,292-293,295	81761.....	296-298	81921.....	293	
81640.....	298-300	81676..... 9,11,16,18,20,38,49,289-290,292-293,295	81762.....	296-298	81922.....	294	
81641.....	298-300	81677.....	81763.....	296-298	81923.....	296	
81642.....	298-300	9,11,16,18,20,289-290,292-293,295	81764.....	296-298	81924.....	296	
81643.....	298-300	81678.....	81765D.....	296-298	81925.....	297	
81644.....	12,304-305	81679.....	81766.....	296-298	81926.....	309	
81645.....	12,304-305	9,11,16,18,20,289-290,292-293,295	81767.....	296-298	81927.....	310	
81646.....	12,304-305	81680.....	81768.....	296-297	81928.....	311	
81647.....	12,304-305	81681.....	81769.....	296-297	81929.....	311	
81648.....	12,304-305	81682.....	81770.....	296-297	81990.....	312	
81649.....	12,304-305	81683.....	81771.....	296-297	82000D.....	344-345,347	
8165010,16,18,20-21,23,38,41,44,289-291,294		81684.....	81772.....	296-297	82001.....	344-345,347	
81651D.....		81685.....	81773.....	296-297	82002D.....	345,347	
10,16,18,20-21,23,290-291,294		81686.....	81774.....	296-297	82003.....	345,347	
81652D.....	10,16,18,20-21,23,38,41,44,289-291,294	81687.....	81775.....	296-297	82004.....	345,348	
8165310,16,18,20-21,23,38,41,44,289-291,294		81688.....	81776.....	296-297	82005D.....	15,17,19,352-353	
8165410,16,18,20-21,23,38,41,44,289-291,294		81689.....	81777.....	296-297	82006D.....	352-353	
81655.....		81690.....	81778.....	296-297	82007.....	354	
10,16,18,20-21,23,38,41,44,49,289-291,294		81691.....	81779.....	296-297	82011.....	9-10,15,17,19,21,23,344-345	
81656.....		81692.....	81780D.....	296-297	82012.....	9-10,15,17,19,21,23,344,346	
9-10,16,18,20-21,23,38,41,44,49,289-291,294		81693.....	81781.....	296-297	82013.....	9-10,15,17,19,21,23,344,346	
81657.....		81694.....	81782.....	310	82014.....	10,15,17,19,21,23,344-345	
9-10,16,18,20-21,23,38,41,44,49,289-291,294		81695.....	81783.....	310	82017.....	352,354	
81658.....	9-10,16,18,20-21,23,38,41,44,289-291,294	81696.....	81784.....	310	82018.....	352,354	
81659.....	9-10,16,18,20-21,23,38,41,44,289-291,294	81697.....	81785.....	310	82019.....	352,354	
81660.....	9-10,16,18,20-21,23,38,41,44,289-291,294	81698.....	81786.....	310	82020D.....	12,15,344-345	
81661.....	9-10,16,18,20-21,23,289-291,294	81699.....	81787.....	309-310	82025.....	15,344,346	
81662.....	9-10,16,18,20-21,23,289-291,294	81700.....	81788.....	309-310	82028.....	15,344,346	
81663.....	9-10,16,18,20-21,23,289-291,294	81701.....	81789.....	309-310	82029.....	355	
81664... 9,11,16,18,21,23,289-291,294		81702.....	81790.....	309-310	82030.....	355-356	
81665.....	9,11,16,18,20,38,41,44,289-290,292-293,295	81703.....	81791.....	309-310	82031.....	355-356	
81666.....	9,11,16,18,20,38,41,44,289-290,292-293,295	81704.....	81792.....	311-312	82032.....	353-354	
81667.....	9,11,16,18,20,38,41,44,289-290,292-293,295	81705.....	81793.....	311-312	82033.....	353-354	
		81706.....	81794D.....	47,51,311-312	82034.....	353,355	
		81707.....	81795.....	311-312	82035.....	348-349	
		81709.....	81796.....	47,51,311-312	82064.....	349	
		81710.....	81797.....	311-312	82065.....	348-349	
		81711.....	81798.....	311	82066.....	349	
		81713.....	81799.....	47,51,311	82068.....	349	
		81714.....	81801.....	47,51,311	82069.....	348-349	
		81715.....	81802.....	311	82070.....	349	
		81717.....	81803.....	311	82071.....	348,350	
		81718.....	81804.....	311	82072.....	350	
		81719.....	81805.....	311	82073.....	348,350	
		81721.....	81890.....	14,312	82074.....	350	
		81722.....	81891.....	14,23,312	82075.....	348,350	
		81723.....	81892.....	14,312	82076.....	351	
		81725.....	81893.....	12,23,312	82100.....	345	
		81733.....	81900.....	290	82103.....	344	

PART NUMBER INDEX

82106	352	82502	122,142	83093	13	84060	430
82107	352	82503	122,142	83094	14	84061	430
82108	344	82504	122,142	83095	15-16	84062	430
82110	353	82505	122,142	83096	19-20	84063	430
82111	353	82506	122,142	83097	17-18	84064	430-431
82114	348	82510	64,98	83098	23	84065	430-431
82116	348	82511	64,98	83101D	34	84070	418
82120	351	82512	64,98	83102	34	84071	418
82121	351-352	82513	64,98	83103	33	84072	418
82124	351	82514	64,98	83104	34	84080	418
82200	384	82515	64,98	83105	34	84081	418
82208	383	82516	64,98	83106D	34	84082	418
82210	383	82517	64,145	83107	34	84083	9-10,16-17,20,418
82212	384	82518	64,145	83108	34	84084	418
82216	10,383	82519	64,145	83109	34	84085	476
82220	12,19,384	82700	329-330	83110D	34	84086	476
82224	383	82701	329-330	83111	34	84087	477
82233	383	82702	329-330	83112D	34	84088	477
82248	384	82703	330	83113D	34	84089	477
82250	375	82704	330	83114D	34	84100	191-194,198
82251	9-10,15,17,19,23,375	82706	329-330	83115	34	84101	191-194,198
82252	375	82707	330	83122BK	32	84102	191-194,198
82253	375	82708	330	83122BU	32	84103	191-194,198
82254	375	82710	330	83122RD	32	84104	191-194,198
82255	10,15,17,19,375	82713	329-330	83123BK	32	84105D	191-194,198
82256	375-376	82715	329-330	83123BU	32	84106	191-194,198
82257	376	82717	329-330	83123RD	32	84107	191-194,198
82258	376	82718	329-330	83124BK	31	84108	191-194,198
82259	10,15,17,19,375-376	82720	330	83124BU	31	84109	191-194,198
82260	9-10,15,17,19,23,375-376	82734	329	83124RD	31	84111	191-192,194-195,199
82261	10,15,17,19,23,377-379	82750	339-340	83125BK	32	84112	191-192,194-195,199
82262	10,15,17,19,23,377-379	82751	339-340	83125BU	32	84113	191-192,194-195,199
82263	377-379	82752	339-340	83125RD	32	84114	191-192,194-195,199
82264	9-10,15,17,19,23,377-379	82753	339-340	83126BK	30	84115	191-192,194-195,199
82265	10,15,17,19,23,377-379	82754	339-340	83126BU	30	84116	191-192,194-195,199
82266	377-379	82755	339-340	83126OR	30	84117	191-192,194-195,199
82267	377,379	82756	339-340	83126RD	30	84118	191-192,194-195,199
82268	377,379	82757D	340	83127BK	31	84119	191-192,194-195,199
82269	377,380	82758	340	83127BU	31	84120	191-192,194-195,199
82270	9-10,15,17,19,23,377-378,380	82759	340	83127OR	31	84121	191-192,194-195,199
82271	377,380	82760	340	83127RD	31	84122	191-192,194-195,199
82272	10,15,17,19,23,377-378,380	82761	340	83130	21,33	84123	191-192,194-195,199
82273	9-10,15,17,19,23,377-380	82762	340	83132	9-10,16-17,20,23,481	84124	191-192,194-195,199
82274	9-10,16-17,19,23,377-380	82763	340	83147	33	84126	191-193,195,199
82275	9-10,16-17,20,23,377-380	82764	340	83148	33	84127	191-193,195,199
82276	377,379-380	82765	339	83151	33	84128	191-193,195,199
82277	377,379-380	82781	334	83152	30	84129	191-193,195,199
82278	10,16-17,20,23,377-380	82782	335	83153	29	84130	191-193,195,199
82279	377,379-380	82783	38,335	83154	28	84131	191-193,195,199
82280	377,379-380	82784	336	83155	29	84132	191-193,195,199
82281	377,379-380	82788	335	83156	27	84133	191-193,195,199
82282	377,380	82800	365,368	83157	28	84134	191-193,195,199
82283	10,16-17,20,23,377-378,380	82801	365,368	83158	27	84135	191-193,195,199
82284	377,380	82802D	365,369	835D	396,476	84137	191-192,194,196,200
82285	10,16-17,20,23,377-378,380	82803D	365,369	83600	480	84138	191-192,194,196,200
82286	377,380	82804	365,369	83601	480	84139	191-192,194,196,200
82287	377,380	82812	365	83602	480	84140	191-192,194,196,200
82289	376	82820	371	84000D	428	84141	191-192,194,196,200
82300	383	82821	371	84001D	13,17,428-429	84142	191-192,194,196,200
82301D	383	82822D	10,17,23,371-372	84002D	13,17,428	84143	191-192,194,196,200
82302	377	82823	10,17,23,371-372	84003D	13,17,428-429	84144	191-192,194,196,200
82303	375	82824	10,17,23,371-372	84004D	13,17,428-429	84145	191-192,194,196,200
82304	378	82825	10,17,23,371-372	84005	13,17,428-429	84146	191-192,194,196,200
82305	378	82881	9-10,16-17,20,23	84006	13,17,428-429	84147	191-192,194,196,200
82306	377	83000	52	84007	13,17,428,430	84148	191-192,194,196,200
82307	379	83001D	49-50	84040	428	84149	191-192,194,196,200
82308	378	83080	21	84051	13,17	84150D	191-192,194,196,200
82309	379	83090	9	84052	13,17	84152	191,196,200
82500	122,142	83091	10-11	84053	13,17	84153	191,196,200
82501	122,142	83092	12	84054D	13,17	84154	191,196,200

84155.....	191,196,200	84356.....	206,211	84540.....	213,220	84614.....	217,225
84156.....	191,196,200	84357.....	206,211	84541.....	213,220	84615.....	217,225
84157.....	191,196,200	84358.....	206,211	84542.....	213,220	84616.....	217,225
84159.....	191,197,201	84359.....	206,211	84543.....	213,220	84617.....	217,225
84160.....	191,197,201	84360.....	206,211	84544.....	213,220	84618.....	217,225
84161.....	191,197,201	84361.....	206,211	84546.....	214,221	84619.....	217,225
84162.....	191,197,201	84362.....	206,211	84547.....	214,221	84620.....	217,225
84163.....	191,197,201	84363.....	206,211	84548.....	214,221	84621.....	217,225
84164.....	191,197,201	84364.....	206,211	84549.....	214,221	84622.....	217,225
84165.....	191,197,201	84365.....	206,211	84550.....	214,221	84623.....	217,225
84166.....	191,197,201	84366.....	206,211	84551.....	214,221	84624.....	217,225
84167.....	191,197,201	84367.....	206,211	84552D.....	214,221	84626.....	216,223
84168.....	191,197,201	84368.....	206,211	84553.....	214,221	84627.....	216,223
84169.....	192,197,201	84389.....	205,210	84554D.....	214,221	84628.....	216,223
84170.....	192,197,201	84390.....	205,210	84555D.....	214,221	84629.....	216,223
84172.....	192,197	84391.....	205,210	84556.....	214,221	84630.....	216,223
84173.....	192,197	84392.....	205,210	84557.....	214,221	84631.....	216,223
84174.....	192,197	84393.....	205,210	84558.....	214,221	84632.....	216,223
84176.....	192,197	84394.....	205,210	84559.....	214,221	84634.....	216,223
84300.....	202-203,208	84395.....	205,210	84560.....	214,221	84635.....	216,223
84301.....	202-203,208	84397.....	205,210	84561.....	214,221	84636.....	216,223
84302.....	202-203,208	84398.....	205,210	84562.....	214,221	84637.....	216,223
84303.....	202-203,208	84399.....	205,210	84563.....	214,221	84638.....	216,223
84304.....	202-203,208	84400D.....	205,210	84564.....	214,221	84639.....	216,223
84305.....	202-203,208	84401.....	205,210	84566.....	215,222	84640.....	216,223
84306.....	202-203,208	84402.....	205,210	84567.....	215,222	84643.....	218
84307.....	202-203,208	84403.....	205,210	84568.....	215,222	84644.....	218
84309.....	202-203,208	84405.....	202,207	84569.....	215,222	84645.....	218
84310.....	202-203,208	84406.....	202,207	84570.....	215,222	84646.....	218
84311.....	202-203,208	84407.....	202,207	84571.....	215,222	84800.....	226
84312.....	202-203,208	84408.....	207	84572.....	215,222	84801.....	226
84313.....	202-203,208	84500D.....	212,219	84573.....	215,222	84802.....	226
84314.....	202-203,208	84501.....	212,219	84574.....	215,222	84803.....	226
84315.....	202-203,208	84502.....	212,219	84575D.....	215,222	84804.....	226
84316.....	202-203,208	84503.....	212,219	84576D.....	215,222	84805.....	226
84317.....	202-203,208	84504D.....	212,219	84577.....	215,222	84806.....	226
84318D.....	202-203,208	84505D.....	212,219	84578.....	215,222	84807.....	226
84319.....	202-203,208	84506D.....	212,219	84579.....	215,222	84808.....	226
84320D.....	202-203,208	84507D.....	212,219	84580.....	215,222	84809.....	226
84322.....	202,204,209	84508D.....	212,219	84581.....	215,222	84810.....	226
84323D.....	202,204,209	84509D.....	212,219	84582.....	215,222	84811.....	226
84324.....	202,204,209	84510D.....	212,219	84583.....	215,222	84812.....	226
84325D.....	202,204,209	84511D.....	212,219	84584.....	215,222	84813.....	226
84326.....	202,204,209	84512D.....	212,219	84585D.....	215,222	84814.....	226
84327.....	202,204,209	84513D.....	212,219	84586D.....	215,222	84815.....	226
84328D.....	202,204,209	84514D.....	212,219	84587.....	215,222	84816.....	226
84329.....	202,204,209	84515D.....	212,219	84588.....	215,222	84818.....	226
84331.....	202,204,209	84516D.....	212,219	84589D.....	215,222	84819.....	226
84332.....	202,204,209	84517D.....	212,219	84590D.....	215,222	84820.....	226
84333.....	202,204,209	84518D.....	212,219	84591.....	215,222	84821.....	226
84334.....	202,204,209	84520.....	213,220	84592.....	215,222	84822.....	226
84335.....	202,204,209	84521D.....	213,220	84593D.....	215,222	84823.....	226
84336.....	202,204,209	84522D.....	213,220	84594D.....	215,222	84824.....	226
84337.....	202,204,209	84523D.....	213,220	84596D.....	217,224	84825.....	226
84338.....	202,204,209	84524D.....	213,220	84597.....	217,224	84826.....	226
84339.....	202,204,209	84525D.....	213,220	84598.....	217,224	84827.....	226
84340.....	202,204,209	84526D.....	213,220	84599.....	217,224	84828.....	226
84341.....	202,204,209	84527D.....	213,220	84600.....	217,224	84830D.....	227
84342.....	202,204,209	84528D.....	213,220	84601.....	217,224	84831.....	227
84343.....	202,204,209	84529D.....	213,220	84602.....	217,224	84832.....	227
84345D.....	206,211	84530D.....	213,220	84603.....	217,224	84833.....	227
84346.....	206,211	84531.....	213,220	84604.....	217,224	84834.....	227
84347.....	206,211	84532.....	213,220	84605.....	217,224	84835.....	227
84348.....	206,211	84533.....	213,220	84606.....	217,224	84836.....	227
84349.....	206,211	84534.....	213,220	84607.....	217,224	84837.....	227
84350.....	206,211	84535.....	213,220	84608.....	217,224	84838.....	227
84351.....	206,211	84536.....	213,220	84610.....	217,225	84839.....	227
84352.....	206,211	84537.....	213,220	84611.....	217,225	84840.....	227
84354.....	206,211	84538.....	213,220	84612.....	217,225	84841.....	227
84355.....	206,211	84539.....	213,220	84613.....	217,225	84842.....	227

84843.....	227	84939.....	217	85221.....	14,280	85450.....	275
84844D.....	227	84940.....	216	85222.....	283-284	85452.....	275
84845.....	227	84941.....	216	85224.....	283-284	85454.....	275
84846.....	227	84942.....	214	85230.....	283-284	85456.....	275
84847.....	227	84944.....	215	85232.....	283-284	85458.....	275
84848.....	227	84946.....	216	85241D.....	283-284	85460.....	275
84849.....	227	85007.....	242	85258.....	233,237	85462.....	275
84850.....	227	85008D.....	238,240,242	85259.....	233,237	85464.....	275
84851.....	227	85009.....	238,240,242	85260.....	233,237	85488.....	274
84852.....	227	85010.....	238,240,242	85261.....	233,237	85498.....	275
84853.....	227	85011.....	238,240,242	85262.....	233,237	85508.....	276,278
84854.....	227	85012.....	238,240,242	85263.....	233,237	85509.....	276,278
84855D.....	227	85013D.....	238,240,242	85264.....	233,237	85510.....	276,278
84856.....	227	85014.....	238,240,242	85265.....	233,237	85511.....	276,278
84857.....	227	85015.....	238,240,242	85266.....	233,237	85512D.....	276,278
84858.....	227	85016.....	238,240,242	85267.....	233,237	85513.....	276,278
84859.....	227	85017.....	238,240,242	85268.....	233,237	85514D.....	276,278
84860.....	227	85018.....	238,240,242	85269.....	233,237	85515.....	276,278
84861.....	227	85019.....	238,240,242	85270.....	233,237	85516.....	276,278
84863.....	228	85020.....	238,242	85271.....	233,237	85517.....	276,278
84864.....	228	85021.....	238,242	85272.....	233,237	85518.....	276,278
84865.....	228	85022.....	238,242	85274.....	233,237	85519.....	276,278
84866.....	228	85024D.....	238,242	85276.....	233,237	85548.....	273-274
84867.....	228	85050.....	315	85278.....	233,237	85550D.....	273-274
84868.....	228	85051.....	315	85280.....	233,237	85552D.....	273-274
84869.....	228	85052.....	315	85282.....	233,237	85554D.....	273-274
84870.....	228	85053.....	315	85284.....	233,237	85556D.....	273-274
84871.....	228	85054.....	315	85288.....	233	85558D.....	273-274
84872.....	228	85055.....	316	85298.....	233	85560.....	273-274
84873.....	228	85056.....	316	85299.....	283	85562D.....	273-274
84874.....	228	85057.....	316	85308.....	234,236	85564.....	273-274
84875.....	228	85070.....	318	85309.....	234,236	85570.....	277
84876.....	228	85071.....	318	85310D.....	234,236	85572.....	277
84877.....	228	85072.....	317	85311.....	234,236	85574.....	277
84878.....	228	85073.....	318	85312D.....	234,236	85576.....	277
84879.....	228	85074.....	318	85313.....	234,236	85578.....	277
84880.....	228	85090R.....	240	85314.....	234,236	85580.....	277
84881.....	228	85098.....	240	85315.....	234,236	85582.....	277
84882.....	228	85099.....	238	85316.....	234,236	85584.....	277
84883.....	228	85099R.....	238	85317.....	234,236	85597.....	276
84885.....	225	850DD.....	413	85318.....	234,236	85598.....	273
84886.....	225	85108.....	239,242	85319D.....	234,236	85599.....	277
84887.....	226	85110.....	239,241-242	85326.....	284	85608.....	259-260,262
84888D.....	226	85112.....	239,241-242	85334.....	284	85609.....	259-260,262
84900.....	193	85114.....	239,241-242	85342.....	284	85610.....	259-260,262
84901.....	194	85116.....	239,241-242	85352.....	284	85611.....	259-260,262
84902.....	192	85118.....	239,241-242	85360.....	234,236	85612.....	259-260,262
84903.....	191-192	85120D.....	239,241-242	85361.....	234,236	85613.....	259-260,262
84904.....	196	85122D.....	239,241-242	85362.....	234,236	85614.....	259-260,262
84905.....	197	85124D.....	239,241-242	85364.....	234,236	85615.....	259-260,262
84906.....	194	85126.....	239,242	85366.....	234,236	85616.....	259-260,262
84907.....	195	85128.....	239,242	85368.....	234,236	85617.....	259-260,262
84908.....	195	85130.....	239,242	85370.....	234,236	85618.....	259-260,262
84909.....	196	85132.....	239,242	85372.....	234,236	85619.....	259-260,262
84910.....	203	85197R.....	241	85374.....	234,236	85698.....	259
84911.....	203	85198.....	241	85388.....	234	85698R.....	260
84912.....	205	85199.....	239	85398.....	234	85710.....	260-261
84913.....	205	85199R.....	239	85399.....	284	85712.....	260-261
84914.....	204	85200.....	278	85418.....	274,276	85714D.....	260-261
84915.....	204	85201.....	278-280	85439D.....	274,276	85716.....	260-261
84916.....	202	85202D.....	278-280	85440D.....	274,276	85718.....	260-261
84917.....	206	85203.....	279-280	85441D.....	274,276	85720.....	260-261
84918.....	206	85204.....	279	85442.....	274,276	85722.....	260-261
84930.....	213	85210D.....	279	85443.....	274,276	85724D.....	260-261
84931.....	212	85211.....	279-280	85444.....	274,276	85798.....	260
84932.....	212	85212.....	279-280	85445.....	274,276	85798R.....	261
84933.....	213	85213.....	279-280	85446.....	274,276	85808.....	232,235
84934.....	214	85214.....	279-280	85447.....	274,276	85809.....	232,235
84935.....	215	85215.....	279	85448.....	274,276	85810.....	232,235
84938.....	217	85220D.....	14,280	85449.....	274,276	85811.....	232,235

85812232,235	89004182,186	891200181-182	9117D243-244,250
85813232,235	890040182	89121119,139,305-306	9118D243-244,246,250
85814232,235	89005182,186	89122119,139,305-306	9119243-244,250
85815232,235	89006182,186	891226181	9120243,250
85816232,235	890060GD338-339	89123119,139,305-306	9121243,247,250
85817232,235	89007182,186	89124119,139,305-306	9122243,247,250
85818232,235	89008182,186	89125119,139,305-306	9124243,247,250
85819232,235	890080GD338-339	89126119,139,305-306	9125D247,250
85850232,235	89009182,186	89127119,139,305-306	9127D250
85851232,235	89010182,186	89128119,139,305-306	912DD416
85852232,235	890100GD338-339	89129119,139,305-306	9130D250
85854232,235	89011182,186	89130119,139,305-306	9132250
85856232,235	890110GD338-339	89140119,139,306-307	9134D250
85858232,235	89012182,186	891400179,182	9136250
85860232,235	890120GD338-339	89141119,139,306-307	9141D250
85862232,235	89013D182,186	89142119,139,306-307	9146D250
85864232,235	89014182,186	891427179	9150250
85888232	890140GD338-339	89143119,139,306-307	9201D281
85898232	89015182,186	89144119,139,306-307	9202D281
85908269,273	89016182,186	89145119,139,306-307	9203281
85909269,273	890160GD338-339	89146119,139,306-307	9204D281
85910269,273	89017182,186	89147119,139,306-307	9207286
85911269,273	89018182,186	89148119,139,306-307	9208D286
85912269,273	89019182,186	89149119,139,306-307	9209D286
85913269,273	89020182,186	8916D338	9210D281-282
85914269,273	89021182,186	8926D333	9211D281-282
85915269,273	89022182,187	893800180,182	9212D281-282
85916269,273	89023182,187	893823180	9213281-282
85917269,273	89024D182,187	8939333	9214281-282
85918269,273	89025D182,187	8940332	9215D281-282
85919269,273	89026182,187	9008243,249	9217286
85920269-270,273	89027182,187	9010D243-245,249	9218D286
85921269-270,273	89028182,187	9011D249	9219286
85922269-270,273	89029182,187	9012D243-246,248-249	9220D285
85924269-270,273	89030182,187	9014243-246,248-249	9221285
85925269-270,273	89031182,187	9016D243-246,248-249	9222285
85950270-272	89032182,187	9018D243-246,248-249	9223285
85951270-272	89033182,187	901DD400	9224D285
85952270-272	89034182,187	9020243,245-246,249	9230D286
85954270-272	89035182,187	9022243,245,249	9231D286
85956270-272	89036182,187	9024243,245,249	9240D281
85958270-272	89037182,187	9026D243,247,249	9260281
85960270-272	89038182,187	9028D243,247,249	93004D247
85962270-272	89039182,187	9030243,247,249	93005246
85964270-272	8908D338	9032243,247,249	9304248
85966270-272	8909D338	9034249	9308D245
85968270-272	89100301	9036249	9309D247
85970270-272	89101D301	9038D249	9312243
85972270-272	89102301-302	9040249	9317245
85987270	89103301-302	9042249	9404248
85988269	89104301-302	9044249	9412244
85989269	89105301-302	9046D249	9413247
85996271	891050GD338-339	9048249	9416243
85998271	89106301-302	9050D249	9417246
85999270	891060GD338-339	9052D249	9418244
86990481	89107301-302	9054D249	9500DD251-252
86991481	891070GD338-339	9056D249	9501DD251-252
890001GD332-334	891080GD338-339	9060D249	9502D251-252
890002GD333-334	89109301	9062D249	9503D251-252
890003GD332-333,337	891090GD338-339	9106250	9504D251-252
890004GD336	89110301	9107250	9505D251-252
890005GD332,334,338	891100GD338-339	9108D243-244,246,250	9506D251-252
890006GD332,334	89111301	9109243-244,250	9507D251
890007GD332,334	891110GD338-339	9110D243-244,246-248,250	9509N254
890008GD332,339	89112301	9111243-244,250	9509RN254
890009GD332,339	891120GD338-339	9112243-244,246-248,250	9510DD251-252
890010GD337	89113301	9113D243-244,246-248,250	9511D251-252
89001D182,186	89118119,305	9114D243-244,246-248,250	9512D251-252
89002D182,186	89119119,306	9115D243-244,246-247,250	9513D251-252
89003182,186	89120119,139,305-306	9116D243-244,250	9514D251-252

PART NUMBER INDEX

9515D	251-252	9705	263-264,266	C7CV	497-498
9516D	251-252	9706	263-264,266	C7SV	498
9517D	251-252	9707	263-264,266	C8SMV	499
9518D	251-252	9708	263-264,266	C9NV	497-498
9519D	251-252	9709	263-264,266	C9W	499
9520D	251	9710	263-264,266	CLP2SET	498
9521ND	254,258	9711	263-264,266	CLP3SET	497
9525ND	254,256,258	9712	263-264,266	CLP3SETC	497
9526ND	254,256,258	9713	263,265-266	CLP5SET	497
9527N	254,256,258	9714D	263,265-266	M1R	14,23,501
9528N	254,256,258,286	9715D	263,265-266	M2R	14,23,501
9529N	254,256,258	9716D	263,265-266	M3R	14,17,23,501
9530ND	254,256,258	9840D	282	PHV1010	500
9531ND	254,256,258	9841D	282-283	PHV1012	500
9532N	254,256,258	9842	282-283	PHV1023CM	500
9533N	256	9843D	282-283	PHV1023CME	500
9534N	254,257-258	9844	282-283	PHV1024CME	500
9535D	285	9850	282	PHV1034CME	500
9537N	286	9851D	282-283	PHV1034DM	500
9538N	254,257-258	9852D	282-283	PHV1035CM	500
9539N	254,257-258	9853	282-283	PHV1035CME	500
9540N	254,257-258	9854	282-283	PHV1048CM	500
9543	257	9855D	282-283	PHV1048CME	500
9545N	257	9900D	265	PHV1048DM	500
9550	267	9901D	263	PHV1312	500
9551	267-268	9902D	262	PHV1312D	500
9552	267-268	9903D	265	PHV1316	500
9553D	267-268	9908D	262-263,266	PHV1410CME	500
9554	267-268	9909D	262-263,266	PHV1425	500
9555	267-268	9910D	262-263,265-266	PHV1425D	500
9556	267-268	9911D	262-263,266	PHV1425ED	500
9557D	267-268	9912D	262-263,265-266	PHV1433	500
9558	267-268	9913D	262-263,265-266	PHV1433DM	500
9559	267-268	9914D	262-263,265-266	PQR1312	500
9560	267-268	9915D	262-263,265-266	PQR1316	500
9567RN	256	9916D	262-263,266	PQR1425	500
9570	267	9917	262-263,265-266	PS3316	10,16-17,20,23
9571	267-268	9918	262-263,266	RWK14D	502
9572	267-268	9919D	262-263,265-266	RWK14V	502
9573	267-268	9921D	262,265-266	RWK16V	502
9574	267-268	9922D	262,265-266	RWK18D	502
9575	267-268	9924D	262,265-266	WKAR1	502
9576	267-268	9925D	262,265-266	WKF1	502
9577	267-268	AC210BK	496		
9601N	258	AC210VS	496		
9601RN	255	AC212BK	496		
9602N	253	AC212VS	496		
9602RN	253	AC215BK	496		
9608N	253,255,257,259	AC215VS	496		
9609N	253,255,259	AC218BK	496		
9610N	253,255,257,259	AC218VS	496		
9611N	253,255,259	AC224BK	496		
9612N	253,255,257,259	AC224VS	496		
9613N	253,255,257,259	AC24BK	496		
9614N	253,255,257,259	AC24VS	496		
9615N	253,255,257,259	AC26BK	496		
9616N	253,255,259	AC26VS	496		
9617N	253,255,257,259	AC28BK	496		
9618N	253,255,259	AC28VS	496		
9619N	253,255,257,259	C10CV	9-10,16-17,20,497-498		
9620N	255	C10SV	498		
9621N	253,258-259	C11CCSV	17,499		
9622N	253,258-259	C11CCV	499		
9624N	253,258-259	C18CCR	499		
9625N	253,258-259	C18CCS	499		
9700	264	C20CH	499		
9701	264	C5CV	16,20,23,497-498		
9702D	263	C6CCSV	499		
9703	265	C6CCV	499		
9704D	263,266	C6NV	10,16-17,20,497-498		

GRAB PRODUCTIVITY BY THE PAWLS

WITH THE **120XP** RATCHET, NOW AVAILABLE IN FLEX-HEAD

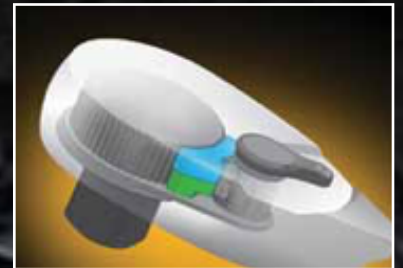

PATENT PENDING DOUBLE-STACKED PAWL™ TECHNOLOGY

120XP ratchets deliver speed, access, and 180% of ASME torque performance.*



GEARWRENCH®

*Results based on manufacturer test of 3/8" drive 120XP ratchet.

GET IT DONE.™

GEARWRENCH®

GET IT DONE.™

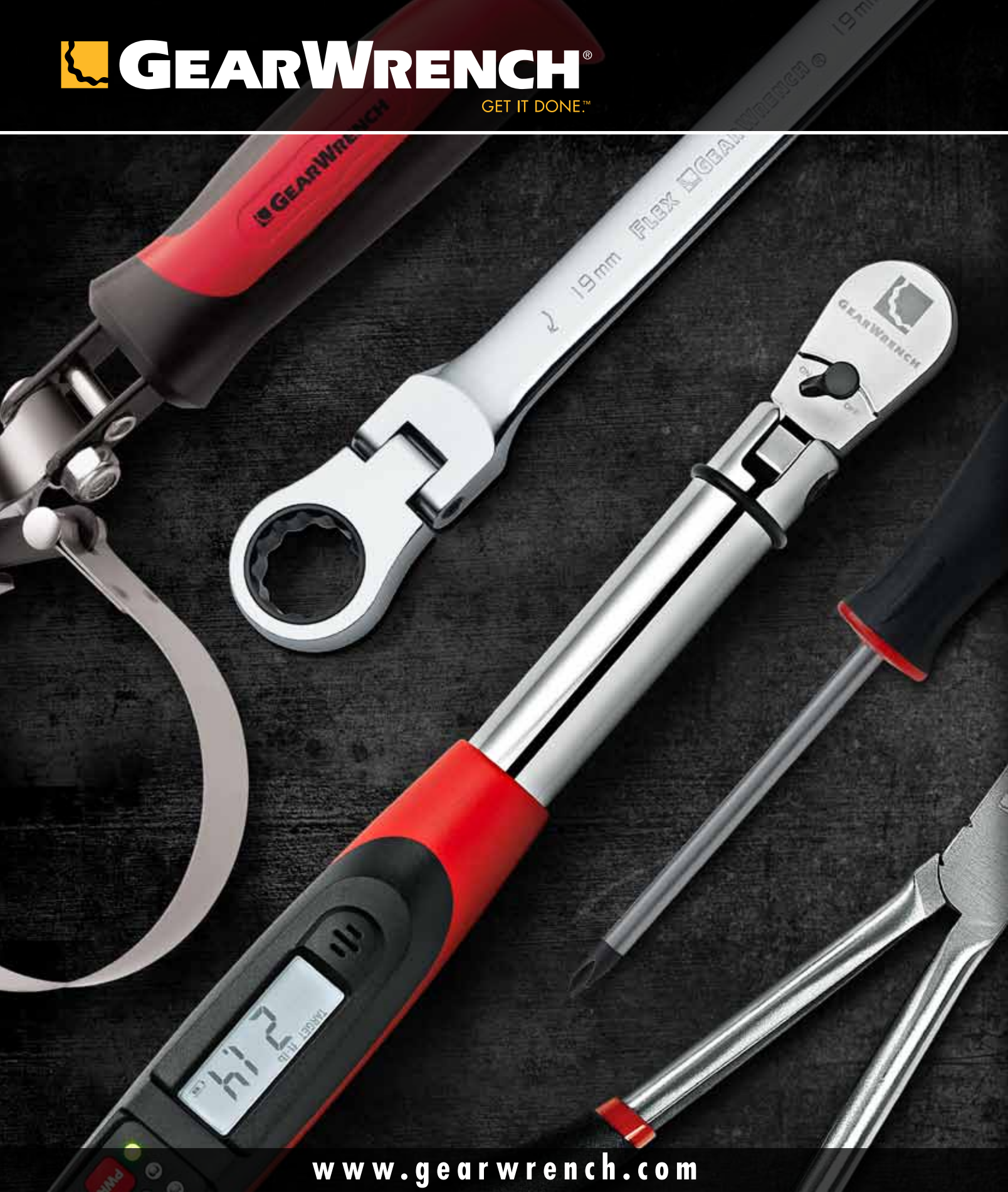

www.gearwrench.com

Apex Tool Group, LLC
14600 York Road, Suite A
Sparks, MD 21152
www.apextoolgroup.com

Printed in U.S.A.
#T550880
8/1/2013

Also includes other Apex Tool Group Brands.