

# Torque Analyzer & Test Measurement

2014 CATALOG



“Making a Safer World  
Through Accuracy and Precision”



**KEY FEATURES**

- Accuracy  $\pm 0.5\%$  of reading from 10% to 100% of full scale.
- Recommended for all pulse tools, hand screwdrivers, torque wrenches and power tools.
- Selection of three operation modes: Track, Peak, and First Peak
- Monitors torque and pulse count. Unit displays both the peak torque & the number of pulses performed during a preset time frame to reach the final torque value.
- Seven units of torque measurements: ozf.in, lbf.in, lbf.ft, cN.m, N.m, kgf.m, kgf.cm
- USB interface to download readings in "real time".
- Easy to use menu structure.
- Eight-digit display.
- Small and lightweight.
- Includes NimH batteries and universal charger 100-240 VAC.
- Over Current Protection (OCP) protects unit from damage or malfunction.
- Menu prompting calibration process.
- Auto filter frequency selection based upon tool type being used in Peak mode.
- Provides "EZ-Plug & Play" with Mountz torque sensors. Features "ARCII" technology, an instant auto-recognition system of the sensors connected to the FTA-100.
- Mountz Data Manager** software for collecting & analyzing data.

RoHS

CE

# TorqueMate® FTA-100

Torque Analyzer with ARCII Technology

**FTA-100** Item #072990

**ACCESSORIES INCLUDED**

Description	Item #
Universal Charger (100-240VAC)	701210
USB Cable	770319
Case	600729
Battery	708005

**CABLE CHART**

Torque Sensor	Item #
BMX	072002
MTX	072003
SDX	072004
RTSX	072005
ETX	072006



Supplied with **Free** ISO 17025 Certification of Calibration.

**NOTE!**

Since a tester cannot always duplicate actual joint characteristics, the torque reading displayed on the FTA may vary from the actual torque that a tool will apply to a joint. When critical assemblies are involved, the torque output of the power tool being used should be verified on the actual assembly using a calibrated measuring torque tool.



Mr. Metric is the leading metric fastener specialist in North America. Well regarded as experts in metric. Mr. Metric is known for hard to find metric items at competitive prices. Visit [www.mrmetric.com](http://www.mrmetric.com)

**Follow Mountz**

Keep informed about our torque tool products, events and industry news. Select your favorite social media site to catch the latest news from Mountz.



# EZ-TorQ II

## Torque Analyzer

TORQUE ANALYZERS

### KEY FEATURES

Accuracy  $\pm$  0.5% of reading from 20% to 100%  
Accuracy  $\pm$  1% of reading from 10% to 20%

Recommended for hand screwdrivers, most wrenches and power tools (Not for use in testing Impact or Pulse type tools).

Selection of three operating modes:  
Track, Peak and First Peak

Seven units of torque measurements:  
ozf.in, lbf.in, lbf.ft, cN.m, N.m, kgf.m, kgf.cm

Features built-in Quick Test operation.

PC Windows based software program:  
**Mountz EZ-TorQ II Interface Program** - to conduct Quick Tool Tests, Data Logging and Sensor Calibration.

"Flash" memory allows upgrades to be done by the user in the field & internet through the RS-232 port.

Easy to use Menu Structure.

Six-digit display.

Ability to download readings to PC via RS-232 or via USB.

Real time output via RS-232.

High Capacity Li-Ion Batteries for long life.

The unit will store a total of up to 150 data points.

Real time graph of torque vs. time using associated PC Windows software.

Features Go / No Go LEDs that illuminate when high or low tolerance setting is achieved or out of tolerance.

Three low-pass filter settings: 130, 150 and 500 Hz.

Includes a Spring Run Down Adapter.

Includes a case, Universal Charger, 1/4 F/Hex Sq. Dr. Adapter, USB Adapter & RS232 Cable Adapter.

Dimensions: (L x W x H): 7 1/4" x 4 1/3" x 2"



### CERTIFIED

Supplied with **Free** ISO 17025 Certification of Calibration.



### NOTE!

Since a tester cannot always duplicate actual joint characteristics, the torque reading displayed on the EZ-TorQ may vary from the actual torque that a tool will apply to a joint. A run down adapter that simulates a variety of different joint characteristics is provided with the EZ-TorQ. When critical assemblies are involved, the torque output of the power tool being used should be verified on the actual assembly using a calibrated measuring torque tool.



RoHS



Model	Item #	Torque Ranges			Drive Size	Weight
		lbf.in	cN.m	kgf.cm		
EZ-TorQ II 10i	070800	1 - 10	11.3 - 113	1.2 - 11.5	17mm Female/Hex*	4.5 lbs.
EZ-TorQ II 50i	070801	5 - 50	56.5 - 565	5.8 - 57.6	17mm Female/Hex*	4.5 lbs.
EZ-TorQ II 100i	070802	10 - 100	113 - 1130	11.5 - 115	17mm Female/Hex*	4.5 lbs.
EZ-TorQ II 150i	070803	15 - 150	169.5 - 1695	17.3 - 173	17mm Female/Hex*	4.5 lbs.

\* Each model includes a 1/4" Female/Hex Sq. Drive Adapter and a Spring Run Down Adapter for testing power tools.



### ACCESSORIES INCLUDED

Item #	Description
770300	Universal Charger (For EZ-TorQ II)
600729	Case (Pictured Above)
603107	Battery Pack (For EZ-TorQ II)
14-501830	Brush Cap
773064	RS-232 Cable
773069	Serial to USB Adapter
600727	1/4 F/Hex Sq. Dr. Adapter (17mm F/Hex)
120143	Square Dr. Adapter (1/4 Sq. Dr x 1/4 Hex x 2" OAL)



### ACCESSORIES OPTIONAL

#### SCREW RUN DOWN ADAPTERS

Item #	Model	American	Metric	Quantity
600728-1*	RDA	2 - 56	M2x.4	5
600728-2*	RDA	4 - 40	M3x.5	5
600728-3*	RDA	6 - 32	M4x.7	5
600728-4*	RDA	8 - 32	M5x.8	5
600734-18*	RDA	5/16 - 18	-	5
600734-20*	RDA	1/4 - 20	-	5

\* Hardware Kit # 1 for these RDA units (includes Washer and Screws), Item # 061237.

See EZ-TorQ manual for a list of items that are included in the Hardware Kit.



### SPRING RUN DOWN ADAPTERS

Provides consistent and reliable torque readings for use with power driven torque control tools.

SEE PAGE O1.16



### CALIBRATION TEST EQUIPMENT

Calibrated Dead Weight and length are the official means by which Analyzers are traced to NIST, ISO etc.

SEE PAGE O1.14

mountztorque.com

ISO 9001 AND ISO 17025 COMPANY

EZ-TORQ

O1.2

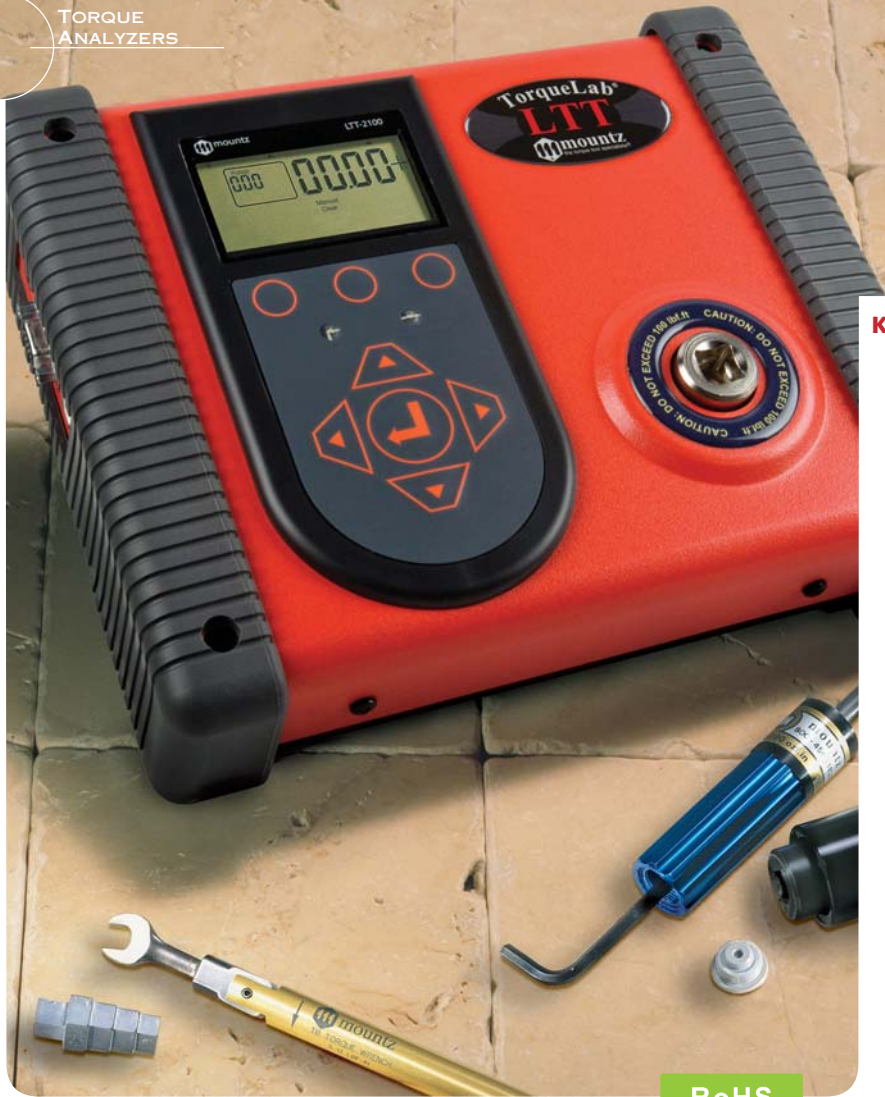

RoHS

CE

# TorqueLab® LTT Series

Torque, Angle & Force Analyzer  
with ARCII Technology

## KEY FEATURES

- Accuracy ± 0.5% of reading from 20% to 100% of full scale.  
Accuracy ± 1% of reading from 10% to 20% of full scale.
- Recommended for all hand screwdrivers, wrenches, or power tools.
- Features a built-in transducer and can connect to an external torque sensor.
- Provides "EZ-Plug & Play" with Mountz torque sensors. Features "ARCII" technology, an instant auto-recognition system of the sensors connected to the LTT.
- Selection of six operation modes:  
Track, Peak, First Peak, Audit, Spindle Audit, and Torque + Angle
- Seven units of torque measurements:  
ozf.in, lbf.in, lbf.ft, cN.m, N.m, kgf.m, kgf.cm
- Two units of force measurement: lbf and kN
- Features built-in Tool Tests operation.
- Three PC Windows based software programs:  
**Mountz Torque Meter Interface Program**  
for sensor calibrations, meter calibration and tool tests.  
**Torque Meter Bootloader**  
for updating the LTT operating systems.  
**Excel Add-In**  
for Real-Time data collection into an Excel spreadsheet.  
It provides statistics calculations.

"Flash" memory allows upgrades to be done by the user in the field & internet through the USB port.

Five low-pass filters: 3000, 2000, 1500, 500, and 200Hz

Six-digit display and easy to read menu structure.

Real Time Clock for time stamping of readings.

USB interface to download readings to PC.

High Capacity Li-ion Batteries for long life (30 hours with standard torque sensors and 16 hours with brushless rotary sensors).

Can connect to most mv/v sensors and can store calibration data for up to 50 non-smart torque sensors.

The 5VDC capability allows unit to be used with a brushless rotary torque sensor for testing pulse tools and high RPM tools.

Torque and Angle data is displayed simultaneously when used with torque and angle sensors, up to 8000 RPM for angle measurement.

Stores a total of 5000 data points.

Real time graph of torque vs. time using associated PC Windows software.

Features Go / No Go LEDs that illuminate when high or low setting is achieved.

Model	Item #	Torque Ranges			Drive Size	Wt.
		American	S.I.	Metric		
LTT10i	068400	1 - 10 lbf.in	11.3 - 113 cN.m	1.2 - 11.5 kgf.cm	1/4" F/Sq	8 lbs.
LTT25i	068401	2.5 - 25 lbf.in	28.25 - 282.5 cN.m	2.9 - 28.8 kgf.cm	1/4" F/Sq	8 lbs.
LTT50i	068402	5 - 50 lbf.in	56.5 - 565 cN.m	5.8 - 57.6 kgf.cm	1/4" F/Sq	8 lbs.
LTT100i	068403	10 - 100 lbf.in	113 - 1130 cN.m	11.5 - 115 kgf.cm	1/4" F/Sq	8 lbs.
LTT250i	068404	25 - 250 lbf.in	282.5 - 2825 cN.m	28.8 - 288 kgf.cm	1/4" F/Sq	8 lbs.
LTT50F	068405	5 - 50 lbf.ft	6.8 - 67.8 N.m	0.7 - 6.9 kgf.m	3/8" F/Sq	8 lbs.
LTT100F	068406	10 - 100 lbf.ft	13.56 - 135.6 N.m	1.4 - 13.8 kgf.m	1/2" F/Sq	8 lbs.
LTT250F	068407	25 - 250 lbf.ft	33.9 - 339 N.m	3.5 - 34.5 kgf.m	1/2" F/Sq	8 lbs.

## ACCESSORIES INCLUDED

Description	Item #
Universal Charger (100-240VAC)	770300
USB Cable	770319
Run Down Adapter	See Pg. 01.16
Mountz Software Programs	-
Case	072605-2
Battery Pack	072506

## ACCESSORIES OPTIONAL

Description	Item #
Multiplexer	072998
Bar Code Reader	072997
Mounting Bracket (for LTT model 10i-50F)	072608
Mounting Bracket (for all LTT models)	072606

## CABLE CHART

Torque Sensor	Item #
RTSX-A	072000
All BLRTSX models	072001
BMX	072002
MTX	072003
SDX	072004
RTSX	072005
ETX	072006



**CERTIFIED**

Supplied with Free ISO 17025 Certification of Calibration.



**NOTE!**

Since a tester cannot always duplicate actual joint characteristics, the torque reading displayed on the LTT may vary from the actual torque that a tool will apply to a joint. When critical assemblies are involved, the torque output of the power tool being used should be verified on the actual assembly using a calibrated measuring torque tool.

# TorqueMate® PTT Series

Torque, Angle & Force Analyzer  
with ARCII Technology

## KEY FEATURES

System Accuracy  $\pm$  0.5% of reading from 20% to 100% of full scale.  
System Accuracy  $\pm$  1% of reading from 10% to 20% of full scale.

Operates with Torque & Force sensors.

Recommended for all hand screwdrivers, wrenches or power tools.

Provides "EZ-Plug & Play" with Mountz torque sensors. Features "ARCII" technology, an instant auto-recognition system of the sensor connected to the PTT.

Selection of six/seven operation modes:

Track, Peak, First Peak, Audit, Bolt Audit\*, Spindle Audit, Torque + Angle.

\*The Bolt Audit Mode is an additional feature that is only available with PTT Bolt Audit Model (Item #072995).

Seven units of torque measurements:

ozf.in, lbf.in, lbf.ft, cN.m, N.m, kgf.m, kgf.cm

Two units of force measurement: lbf and kN

Features built-in Tool Tests operation.

Three PC Windows based software programs:

**Mountz Torque Meter Interface Program**

for sensor calibrations, meter calibration, and tool tests.

**Torque Meter Bootloader**

for updating the PTT operating systems.

**Excel Add-In**

for Real-Time data collection into an Excel spreadsheet.  
It provides statistic calculations.

"Flash" memory allows upgrades to be done by the user in the field & internet through the USB port.

Five low-pass filters: 3000, 2000, 1500, 500, and 200Hz

Six-digit display and easy to read menu structure.

Real Time Clock for time stamping of readings.

USB interface to download readings to PC.

High Capacity Li-ion Batteries for long life (30 hours with standard torque sensors and 16 hours with brushless rotary sensors).

Can connect to most mv/v sensors and can store calibration data for up to 50 non-smart torque sensors.

The 5VDC capability allows unit to be used with a brushless rotary sensors for testing pulse tools and high RPM tools.

Torque and Angle data is displayed simultaneously when used with torque and angle sensors, up to 8000 RPM for angle measurement.

Stores a total of 5000 data points.

Real time graph of torque vs. time using associated PC Windows software.

Features Go / No Go LEDs that illuminate when high or low setting is achieved.



## CERTIFIED

Supplied with Free ISO 17025  
Certification of Calibration.



## PLUG & PLAY



## NOTE!

Since a tester cannot always duplicate actual joint characteristics, the torque reading displayed on the PTT may vary from the actual torque that a tool will apply to a joint. When critical assemblies are involved, the torque output of the power tool being used should be verified on the actual assembly using a calibrated measuring torque tool.

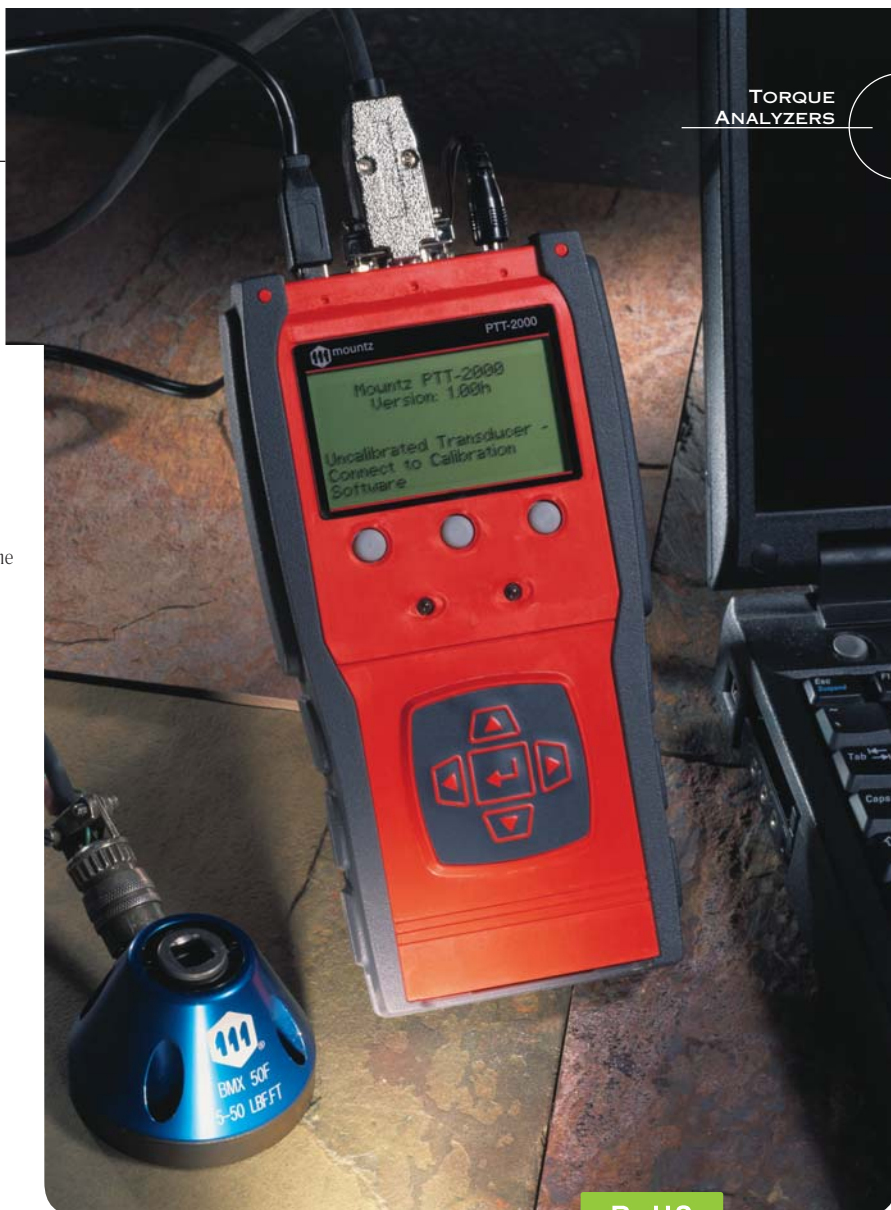

RoHS

CE

**PTT-2000** Item #072999

**PTT-2000 Bolt Audit Model**  
(for HSD Multipliers) - Item #072995

## ACCESSORIES INCLUDED

Description	Item #
Universal Charger (100-240VAC)	770300
USB Cable	770319
Mountz Software Programs	-
Case	072509
Battery Pack	072506

## ACCESSORIES OPTIONAL

Description	Item #
Multiplexer	072998
Bar Code Reader	072997

## CABLE CHART

Torque Sensor	Item #
RTSX-A	072000
All BLRTSX Models	072001
BMX	072002
MTX	072003
SDX	072004
RTSX	072005
ETX	072006



## Tool Tests & Graphing

The PTT allows you to set up and create tool tests and save the readings so you can export the data to a PC for documentation. It is the ideal solution for organizing and storing test data for ISO and SPC documentation.

The ability to graph a dynamic rundown allows joint analysis. Great resource to evaluate, create or confirm a torque specification or tool being used in production.

# Capture

## Torque Analyzer



RoHS

CE

### CAPTURE DISPLAY Item #020665

- System accuracy  $\pm 0.5\%$  of reading from 10-100% of full scale.
- Enables calibration and analysis of hand and power torque tools.
- Selection of three operation modes: Track, Peak & First Peak
- Seven units of torque measurements: (ozf.in, lbf.in, lbf.ft, cN.m, N.m, kgf.m, kgf.cm).
- Real time clock for time stamping of readings.
- USB interface to download readings to PC.
- Easy to use menu system.
- Five-digit display.
- High capacity Li-ion batteries for long life and universal charger (100-240 VAC).
- Color display that features clear visual warnings for the operator: Go / No Go and sensor overload.
- Tool Database - stores up to 500 tools.
- Reading database - stores up to 2000 readings.



### NOTE!

Since a tester cannot always duplicate actual joint characteristics, the torque reading displayed on the Capture may vary from the actual torque that a tool will apply to a joint. When critical assemblies are involved, the torque output of the power tool being used should be verified on the actual assembly using a calibrated measuring torque tool.



### CERTIFIED

Supplied with Free ISO 17025 Certification of Calibration.



### CAPTURE MANAGER PC SOFTWARE Item #020666

- The optional software extends the capability of the Capture Display as it manages and archives the saved torque readings.
- Seamless transfer data results to Microsoft® Excel. The software allows for quick and easy access to the stored data.
- Expands the storage capacity of the tool database and data readings, which can be uploaded and downloaded to Capture Display.
- Ability to test and produce customized tool Calibration Certificates to ISO 6789.



### CAPTURE TORQUE SENSORS

- These torque sensors are used in conjunction with the Capture torque analyzer.
- Various models that range from 1.8 lbf.in to 1,107 lbf.ft.
- Flexible sensor can be mounted horizontally or vertically.
- Quick set up when used with a Capture display due to the imbedded Quicktec technology, which passes all the sensor information to the display.

Model	Item #	Torque Ranges		H x W x D	Drive Size
		American	S.I.		
CS 2	020667	1.8 - 17.7 lbf.in	0.2 - 2 N.m	2-1/2" x 3-1/3" x 2-1/2"	1/4"
CS 10	020668	8.9 - 88.5 lbf.in	1 - 10 N.m	2-1/2" x 3-1/3" x 2-1/2"	1/4"
CS 50	020669	3.7 - 37 lbf.ft	5 - 50 N.m	2-1/2" x 3-1/3" x 2-1/2"	3/8"
CS 250	020670	18.5 - 184.5 lbf.ft	25 - 250 N.m	3-1/4" x 4-3/4" x 3-1/2"	1/2"
CS 1500	020671	110.7 - 1107 lbf.ft	150 - 1500 N.m	4" x 6-1/3" x 5-1/4"	1"

### CABLE Item # 020672

For connecting CS torque sensors to Capture Display



# Dial Analyzers

## Hand Tool Torque Analyzers

### KEY FEATURES

- Accuracy  $\pm 2\%$  of reading from 20% to 100% of full scale.
- Easy to read dual scale (Metric & American).
- Memory style master pointer retains maximum readings.
- Designed for all types of hand torque wrenches and screwdrivers.
- Bench mount style.
- Clockwise direction only (MTS models).
- Reversible drive adapters provide two drive options per model (MTS models).
- Robust and modern design includes angled dial for easy viewing (MTS models).
- Spindle lock eliminates the need to remove tool from drive during torque adjustment (MTS models).
- Input drive shock absorber protects from tool kick back (MTS models).
- Bi-directional & fitted with 1/4" Male hex drive (MTP model).
- Dial mirror eliminates parallax error. Uses pendulum effect to measure the applied torque (MTP model).



**Mountz Torque Conversion Calculator**  
Quickly convert torque measurement from one type of unit measurement to another. Visit [www.mountztorque.com/calculator](http://www.mountztorque.com/calculator)

Model	Item #	Torque Ranges	
		American	S.I.
MTP 10	020000	0 - 14 ozf.in	0 - 10 cN.m
MTS 35	020001	10 - 50 ozf.in	7 - 35 cN.m
MTS 130	020002	36 - 180 ozf.in	26 - 130 cN.m
MTS 400	020003	7 - 36 lbf.in	0.8 - 4 N.m
MTS 1200	020004	24 - 120 lbf.in	2.4 - 12 N.m
MTS 2500	020005	44 - 220 lbf.in	5 - 25 N.m

Model	Graduation		Pointer	Weight	
	American	S.I.		lbs.	kg.
MTP 10	1 ozf.in	0.5 cN.m	Single	2.16	0.98
MTS 35	0.5 ozf.in	0.5 cN.m	Memory	7.1	3.2
MTS 130	2 ozf.in	2 cN.m	Memory	7.1	3.2
MTS 400	0.5 lbf.in	0.05 N.m	Memory	7.1	3.2
MTS 1200	2 lbf.in	0.2 N.m	Memory	7.1	3.2
MTS 2500	5 lbf.in	0.5 N.m	Memory	7.1	3.2



### CERTIFIED

Supplied with Free ISO 17025 Certification of Calibration



### REVERSIBLE ADAPTER 1/4" M/HEX & 1/4" F/SQ.

For models: MTS 35, 130, 400



### REVERSIBLE ADAPTER 1/4" F/SQ. & 3/8" F/SQ.

For models: MTS 1200, 2500



### NOTE!

Do not use with electric or pneumatic tools.

# MTX

## Low Torque Reaction Sensor with ARC II Technology

Model	Item #	Torque Ranges	
		American	S.I.
MTX10z	079007	1 - 10 ozf.in	0.7 - 7.1 cN.m
MTX20z	079008	2 - 20 ozf.in	1.5 - 14 cN.m
MTX40z	079009	4 - 40 ozf.in	2.9 - 28.2 cN.m
MTX80z	079010	8 - 80 ozf.in	5.7 - 56.5 cN.m
MTX160z	079011	16 - 160 ozf.in	11.3 - 113 cN.m

### DRIVE SIZE & DIMENSIONS

Model	Drive Size	Length	Width	Height
MTX10z	1/4 Female Square	2.55	1.6	1
MTX20z	1/4 Female Square	2.55	1.6	1
MTX40z	1/4 Female Square	2.55	1.6	1
MTX80z	1/4 Female Square	2.55	1.6	1
MTX160z	1/4 Female Square	2.55	1.6	1

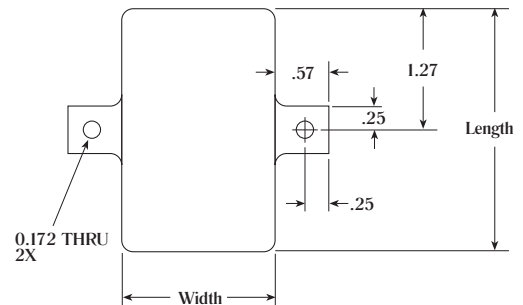

### SPECIFICATIONS

- Rated Output: 2mv/v Nominal
- Safe Overload: 125% of Rated Output
- Bridge Resistance: 350 Ohms Nominal
- Nonlinearity: ± 0.1% of Rated Output

### MTX CABLE

Item #072003  
For connecting to FTA-100, PTT or LTT

#### CONNECTION

- 1 = Signal (+)
- 2 = Signal (-)
- 3 = Excitation (-)
- 4 = Excitation (+)
- 5 = Ground
- 6 = Data

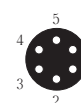

### MOUNTING BRACKET

Item #062109  
Model: MB-1  
Dimensions: 4" x 3" x 4"



### ACCESSORIES



### RUN DOWN ADAPTERS

Provides consistent and reliable torque readings for use with power driven torque control tools.  
SEE PAGE O1.16



### LTT

Offers "EZ-Plug & Play" with instant auto recognition with Mountz "ARCII" torque sensors.  
SEE PAGE O1.3

### KEY FEATURES

- Accuracy ± 0.25% of full scale.\*
- For calibrating low torque hand screwdrivers, wrenches, and power tools.
- The low profile design makes it ideal for calibrating robotic drivers on the assembly line.
- Various models that range from 1-160 ozf.in.
- Features "ARCII" technology, an instant auto-recognition system of the MTX connected to the FTA-100, PTT or LTT.
- Mountable.
- 1/4" female square drive.
- Bi-directional.



### NOTE!

\*This is the "stand alone" accuracy for the torque sensor. When the torque sensor is coupled with a Mountz torque analyzer, there is a system accuracy. Review the system accuracy listed with each torque analyzer.



### CERTIFIED

Supplied with Free ISO 17025 Certification of Calibration.



### WARNING!

Always use a run down adapter when testing power tools.



### PLUG & PLAY



# BMX

## Torque Reaction Sensor with ARCIi Technology

Model	Item #	Torque Ranges	
		American	S.I.
BMX20z	077000	2 - 20 ozf.in	1.5 - 14 cN.m
BMX40z	077001	4 - 40 ozf.in	2.9 - 28.2 cN.m
BMX80z	077002	8 - 80 ozf.in	5.7 - 56.5 cN.m
BMX10i	077003	1 - 10 lbf.in	11.3 - 113 cN.m
BMX25i	077004	2.5 - 25 lbf.in	28 - 282.5 cN.m
BMX50i	077005	5 - 50 lbf.in	56.5 - 565 cN.m
BMX100i	077006	10 - 100 lbf.in	113 - 1130 cN.m
BMX250i	077007	25 - 250 lbf.in	282.5 - 2825 cN.m
BMX500i	077008	50 - 500 lbf.in	565 - 5650 cN.m
BMX750i	077009	75 - 750 lbf.in	847 - 8473 cN.m
BMX50F	077010	5 - 50 lbf.ft	6.8 - 67.8 N.m
BMX100F	077011	10 - 100 lbf.ft	13.6 - 135.6 N.m
BMX250F	077012	25 - 250 lbf.ft	33.9 - 339 N.m
BMX500F	077013	50 - 500 lbf.ft	67.8 - 678 N.m
BMX1000F	077014	100 - 1000 lbf.ft	135.6 - 1355 N.m
BMX2500F	077015	250 - 2500 lbf.ft	339 - 3389 N.m
BMX5000F	077016	500 - 5000 lbf.ft	678 - 6779 N.m
BMX10000F	077017	1000 - 10000 lbf.ft	1335 - 13558 N.m
BMX20000F	077018	2000 - 20000 lbf.ft	2711 - 27116 N.m

### SPECIFICATIONS

Rated Output: 2mV/v Nominal      Bridge Resistance: 350 Ohms Nominal  
 Safe Overload: 125% of Rated Output      Nonlinearity: ± 0.1% of Rated Output

### DIMENSIONS

Model	A	B	C	D	E	Drive Size
BMX20z	2.75	2.1	1.7	0.25	2.175	1/4
BMX40z	2.75	2.1	1.7	0.25	2.175	1/4
BMX80z	2.75	2.1	1.7	0.25	2.175	1/4
BMX10i	2.75	2.1	1.7	0.25	2.175	1/4
BMX25i	2.75	2.1	1.7	0.25	2.175	1/4
BMX50i	2.75	2.1	1.7	0.25	2.175	1/4
BMX100i	2.75	2.1	1.7	0.25	2.175	1/4
BMX250i	2.75	2.1	1.7	0.25	2.175	1/4
BMX500i	2.75	2.1	1.7	0.25	2.175	3/8
BMX750i	2.75	2.1	1.75	0.25	2.175	3/8
BMX50F	2.75	2.1	1.75	0.25	2.175	3/8
BMX100F	4	2.75	2.25	0.413	3	1/2
BMX250F	4	2.75	2.25	0.413	3	1/2
BMX500F	4	3	2.4	0.413	3	3/4
BMX1000F	4	3.75	2.38	0.406	3	1
BMX2500F	6	4.65	3.88	0.531	4.75	1 1/2
BMX5000F	6	4.65	3.88	0.531	4.75	1 1/2
BMX10000F	10.5	10.5	6.5	0.781*	8.875	2 1/2
BMX20000F	10.5	10.5	6.5	0.781*	8.875	2 1/2

\*Models have 8 mounting holes.

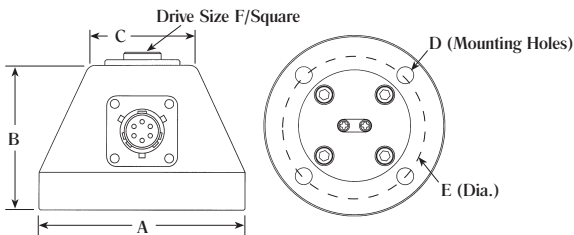

### KEY FEATURES

Accuracy ± 0.25% of full scale\*  
 Accuracy ± 0.5% of full scale (BMX10000F, 20000F)\*

For calibrating hand screwdrivers, wrenches, and power tools.

Various models that range from 2 ozf.in to 20000 lbf.ft.

Features "ARCIi" technology, an instant auto-recognition system of the BMX connected to the FTA-100, LTT and PTT.

Mountable.

Female square drive.

Bi-directional.

### BMX CABLES

Item #072002

For connecting to FTA-100, LTT or PTT

### CONNECTION

A = Excitation (+)  
 B = Excitation (-)  
 C = Signal (-)  
 D = Signal (+)  
 E = N/A  
 F = N/A



### NOTE!

\*This is the "stand alone" accuracy for the torque sensor. When the sensor is coupled with a Moutnz torque analyzer, there is a system accuracy. Review the system accuracy listed with each torque analyzer.



### PLUG & PLAY



### CERTIFIED

Supplied with Free ISO 17025 Certification of Calibration.



### WARNING!

Always use a run down adapter when testing power tools. Not recommended for impact wrenches.

CONNECT WITH A:



### LTT

Offers "EZ-Plug & Play" with instant auto recognition with Moutnz "ARCIi" transducers. SEE PAGE O1.3



### MOUNTING BRACKET

SEE PAGE O1.17

# RTSX

## Rotary Torque Sensor with ARCI Technology



TORQUE SENSORS

Model	Item #	Torque Ranges	
		American	S.I.
RTSX10i-H	170200	1 - 10 lbf.in	11.3 - 113 cN.m
RTSX10i	170201	1 - 10 lbf.in	11.3 - 113 cN.m
RTSX50i-H	170202	5 - 50 lbf.in	56.5 - 565 cN.m
RTSX50i	170203	5 - 50 lbf.in	56.5 - 565 cN.m
RTSX100i-H	170204	10 - 100 lbf.in	113 - 1130 cN.m
RTSX100i	170205	10 - 100 lbf.in	113 - 1130 cN.m
RTSX200i-H	170206	20 - 200 lbf.in	226 - 2260 cN.m
RTSX200i	170207	20 - 200 lbf.in	226 - 2260 cN.m
RTSX50F	170208	5 - 50 lbf.ft	6.8 - 67.8 N.m
RTSX100F	170209	10 - 100 lbf.ft	13.6 - 135.6 N.m
RTSX400F	170210	40 - 400 lbf.ft	54.2 - 542.4 N.m
RTSX738F	170211	74 - 738 lbf.ft	100 - 1000 N.m
RTSX1500F	170212	150 - 1500 lbf.ft	203.3 - 2033 N.m

### DRIVE SIZE

Model	Input	Output
RTSX10i-H	1/4 Male/Hex	1/4 Female/Hex
RTSX10i	1/4 Female/Square	1/4 Male/Square
RTSX50i-H	1/4 Male/Hex	1/4 Female/Hex
RTSX50i	1/4 Female/Square	1/4 Male/Square
RTSX100i-H	1/4 Male/Hex	1/4 Female/Hex
RTSX100i	1/4 Female/Square	1/4 Male/Square
RTSX200i-H	1/4 Male/Hex	1/4 Female/Hex
RTSX200i	3/8 Female/Square	3/8 Male/Square
RTSX50F	3/8 Female/Square	3/8 Male/Square
RTSX100F	1/2 Female/Square	1/2 Male/Square
RTSX400F	3/4 Female/Square	3/4 Male/Square
RTSX738F	1 Female/Square	1 Male/Square
RTSX1500F	1 1/2 Female/Square	1 1/2 Male Square

### KEY FEATURES

Accuracy  $\pm 0.25\%$  of full scale\*.

Use with most hand tools, power tools, or rotational measurement applications.

Connects between the power tool and the joint. Monitors actual torque being applied from the driver to the fastener.

Features "ARCI" technology, an instant auto-recognition system of the RTSX connected to the FTA-100, PTT or LTT.

Bi-directional.

### RTSX CABLES

#### Item #072005

For connecting to FTA-100, PTT or LTT

#### Item #072000

For connecting FTA-100, PTT or LTT to RTSX1500F

#### CONNECTION

- A = Excitation (+)
- B = Excitation (-)
- C = Output (-)
- D = Output (+)
- E = Shield
- F = 100% control (full scale)

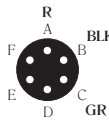

CONNECT WITH A:



### ANALYZER

FTA-100 (shown)  
SEE PAGE O1.1



### CERTIFIED

Supplied with Free ISO 17025 Certification of Calibration.



### WARNING!

Not recommended for impact wrenches.



### PLUG & PLAY



### NOTE!

\*This is the "stand alone" accuracy for the torque sensor. When the sensor is coupled with a MOUNTZ torque analyzer, there is a system accuracy. Review the system accuracy listed with each torque analyzer.

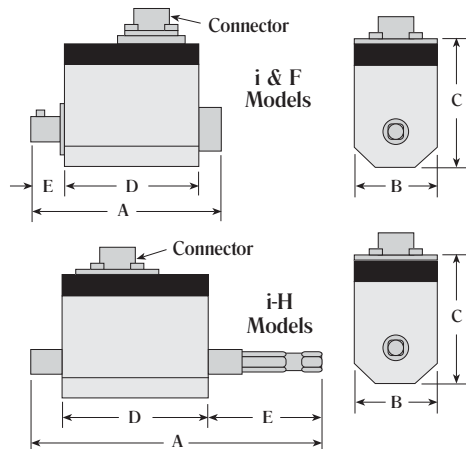

### SPECIFICATIONS

Output at Rated Capacity:  $\leq 6$  Nm [53 lbf.in] rated torque 1 mV/V  
 $> 6$  Nm [53 lbf.in] rated torque 2 mV/V

Interchangeability: Matched for mv/v and shunt calibration + 0.3% FS

Nonlinearity: + 0.2% FS

Excitation Recommended: 10V DC or AC RMS

Bridge Resistance: 350 Ohms

Usable Temperature Range: 41 - 122 °F

Mating Connector: Bendix PT06A-10-65 (SR)

Safe Overload: 125% of Rated Output

### DIMENSIONS

Model	A	B	C	D	E
RTSX10i-H	101	28	52	58	28
RTSX10i	75	28	52	58	8.5
RTSX50i-H	101	28	52	58	28
RTSX50i	75	28	52	58	8.5
RTSX100i-H	101	28	52	58	28
RTSX100i	75	28	52	58	8.5
RTSX200i-H	101	28	52	58	28
RTSX200i	74.5	38	58	44	18
RTSX50F	74.5	38	58	44	18
RTSX100F	79	38	58	44	22.5
RTSX400F	97	58	76	50	30
RTSX738F	112	73	90	57	34.5
RTSX1500F	165	110	126	87	44

# RTSX-A

## Rotary Torque & Angle Sensor with ARCII Technology

Model	Item #	Torque Ranges	
		American	S.I.
RTSX10i-HA	170213	1 - 10 lbf.in	11.3 - 113 cN.m
RTSX10i-A	170214	1 - 10 lbf.in	11.3 - 113 cN.m
RTSX50i-HA	170215	5 - 50 lbf.in	56.5 - 565 cN.m
RTSX50i-A	170216	5 - 50 lbf.in	56.5 - 565 cN.m
RTSX100i-HA	170217	10 - 100 lbf.in	113 - 1130 cN.m
RTSX100i-A	170218	10 - 100 lbf.in	113 - 1130 cN.m
RTSX200i-HA	170219	20 - 200 lbf.in	226 - 2260 cN.m
RTSX200i-A	170220	20 - 200 lbf.in	226 - 2260 cN.m
RTSX50F-A	170221	5 - 50 lbf.ft	6.8 - 67.8 N.m
RTSX100F-A	170222	10 - 100 lbf.ft	13.6 - 135.6 N.m
RTSX400F-A	170223	40 - 400 lbf.ft	54.2 - 542.4 N.m
RTSX800F-A	170224	80 - 800 lbf.ft	108.4 - 1084 N.m
RTSX1500F-A	170282	150 - 1500 lbf.ft	203.3 - 2033N.m

### SPECIFICATIONS

Output at Rated Capacity:  $\leq 6$  Nm [53 lbf.in] rated torque 1 mV/V  
 $> 6$  Nm [53 lbf.in] rated torque 2 mV/V

Interchangeability: Matched for mv/v and  
 Shunt Calibration + 0.3% FS

Nonlinearity: + 0.2% FS

Excitation Recommended: 12V DC or AC RMS

Bridge Resistance: 350 Ohms

Usable Temperature Range: 41 - 122°F

Mating Connector: Bendix PT06A-12

Safe Overload: 125% of Rated Output

### DRIVE SIZE

Model	Input	Output
RTSX10i-HA	1/4 Male/Hex	1/4 Female/Hex
RTSX10i-A	1/4 Female/Square	1/4 Male/Square
RTSX50i-HA	1/4 Male/Hex	1/4 Female/Hex
RTSX50i-A	1/4 Female/Square	1/4 Male/Square
RTSX100i-HA	1/4 Male/Hex	1/4 Female/Hex
RTSX100i-A	1/4 Female/Square	1/4 Male/Square
RTSX200i-HA	1/4 Male/Hex	1/4 Female/Hex
RTSX200i-A	1/4 Female/Square	1/4 Male/Square
RTSX50F-A	3/8 Female/Square	3/8 Male/Square
RTSX100F-A	1/2 Female/Square	1/2 Male/Square
RTSX400F-A	3/4 Female/Square	3/4 Male/Square
RTSX800F-A	1 Female/Square	1 Male/Square
RTSX1500F-A	1 1/2 Female/Square	1 1/2 Male/Square



### CERTIFIED

Supplied with Free ISO 17025 Certification of Calibration.



### WARNING!

Not recommended for impact wrenches.



### PLUG & PLAY



### NOTE!

\*This is the "stand alone" accuracy for the torque sensor. When the sensor is coupled with a Mountz torque analyzer, there is a system accuracy. Review the system accuracy listed with each torque analyzer.



### KEY FEATURES

Accuracy  $\pm 0.25\%$  of full scale\*.

Ability to measure the rotation angle of a fastener.  
 Joint rate and breakaway torque can be measured too.

Angle Output: 2 channel quadrature, 360 pulses per rotation.

Bi-directional.

For use with most power tools or rotational measurement applications.

Features "ARCII" technology, an instant auto-recognition system of the RTSX-A connected to the PTT or LTT.

### DIMENSIONS

Model	A	B	C	D	E
RTSX10i-HA	101	28	52	58	28
RTSX10i-A	75	28	52	58	8.5
RTSX50i-HA	101	28	52	58	28
RTSX50i-A	75	28	52	58	8.5
RTSX100i-HA	101	28	52	58	28
RTSX100i-A	75	28	52	58	8.5
RTSX200i-HA	101	28	52	58	28
RTSX200i-A	75	28	52	58	8.5
RTSX50F-A	101	38	58	59	21.5
RTSX100F-A	106	38	58	59	26
RTSX400F-A	135	58	76	64	40
RTSX800F-A	177	73	90	73	57.5
RTSX1500F-A	165	110	126	87	39

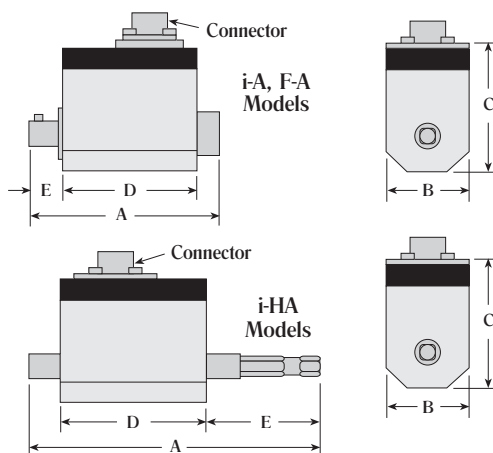

### CONNECT WITH A:



### PTT

Ability to document and save torque readings.  
 Ideal for SPC testing and ISO testing.  
 SEE PAGE O1.4



### RTSX-A CABLE

#### Item #072000

For connecting to PTT or LTT

### CONNECTION

#### Torque Output

- A = Bridge Voltage (+)
- B = Bridge Voltage (-)
- C = Measured Signal (+)
- D = Measured Signal (-)
- E = Ground (Angle Voltage)
- F = +5V (Angle Voltage)

#### Angle Output

- G = Channel A (Load)
- H = Channel B (Lag)
- I = N/A
- K = 100% Control (Full Scale)

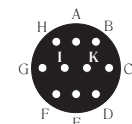



**KEY FEATURES**

- Accuracy  $\pm 0.2\%$  of full scale\*.
- Non-contact signal transfer and maintenance free.
- Angle Output: 2-channel quadrature, 360 pulses per rotation.
- Ability to measure the rotation angle of a fastener. Joint rate & breakaway torque can be measured too.
- The common "brush bounce" that plagues the accuracy testing of pulse tools is cured when using a brushless rotary transducer.
- Compact design & bi-directional.
- For use with most power tools, high RPM tools, or rotational measurement applications.
- Features "ARCII" technology, an instant auto-recognition system of the BLRTSX-A connected to the PTT or LTT.



**CERTIFIED**

Supplied with Free ISO 17025 Certification of Calibration.



**PLUG & PLAY**



**NOTE!**

\*This is the "stand alone" accuracy for the torque sensor. When the sensor is coupled with a Mounzt torque analyzer, there is a system accuracy. Review the system accuracy listed with each torque analyzer.



**BLRTSX-A CABLE**

For connecting to PTT or LTT.

Item #072001

**CONNECTION**

- A = Ground (Shunt Calibration)
- B = Angle 1 Speed
- C = Torque Output
- D = Ground (Torque Output)
- E = Ground (Supply)
- F = Supply, 11-26 VDC, 1 W
- G = Angle 2 (90° running after Angle 1)
- H = +5V (Angle Voltage)
- K = Shunt Calibration
- M = Shield
- J & L = N/A



# BLRTSX-A

Brushless Rotary Torque & Angle Sensor  
with ARCII Technology

Model	Item #	Torque Ranges	
		American	S.I.
BLRTSX28z-HA	170283	10 - 28 ozf.in	7 - 20 cN.m
BLRTSX70z-HA	170246	10 - 70 ozf.in	7 - 49 cN.m
BLRTSX140z-HA	170247	25 - 140 ozf.in	18 - 98.8 cN.m
BLRTSX18i-HA	170248	2 - 18 lbf.in	22.5 - 203 cN.m
BLRTSX50i-HA	170249	5 - 50 lbf.in	56.5 - 565 cN.m
BLRTSX100i-HA	170250	10 - 100 lbf.in	113 - 1130 cN.m
BLRTSX100i-A	170251	10 - 100 lbf.in	113 - 1130 cN.m
BLRTSX160i-HA	170252	16 - 160 lbf.in	180 - 1807 cN.m
BLRTSX160i-A	170253	16 - 160 lbf.in	180 - 1807 cN.m
BLRTSX36F-A	170254	4 - 36 lbf.ft	5 - 50 N.m
BLRTSX73F-A	170255	8 - 73 lbf.ft	10 - 100 N.m
BLRTSX118F-A	170256	12 - 118 lbf.ft	16 - 160 N.m
BLRTSX184F-A	170257	19 - 184 lbf.ft	25 - 250 N.m
BLRTSX368F-A	170258	37 - 368 lbf.ft	50 - 500 N.m
BLRTSX738F-A	170259	74 - 738 lbf.ft	100 - 1000 N.m

**SPECIFICATIONS**

- Rated Output:  $\pm 5\text{VDC} \pm 0.2\% \text{ FS}$
- Excitation Recommended: 11VDC to 26VDC (pole secure)
- Nonlinearity:  $\pm 0.2\% \text{ FS}$
- Usable Temperature Range 41 to 122°F
- Mating Connector: Tuchel Series 581 (98-2030-09-12)
- Safe Overload: 150% of Rated Output

Model	Drive Size (inches)		Dimensions (mm)				
	Input	Output	A	B	C	D	E
BLRTSX28z-HA	1/4 M/Hex	1/4 F/Hex	101	28	52	58	28
BLRTSX70z-HA	1/4 M/Hex	1/4 F/Hex	101	28	52	58	28
BLRTSX140z-HA	1/4 M/Hex	1/4 F/Hex	101	28	52	58	28
BLRTSX18i-HA	1/4 M/Hex	1/4 F/Hex	101	28	52	58	28
BLRTSX50i-HA	1/4 M/Hex	1/4 F/Hex	101	28	52	58	28
BLRTSX100i-HA	1/4 M/Hex	1/4 F/Hex	101	28	52	58	28
BLRTSX100i-A	1/4 F/Sq	1/4 M/Sq	75	28	52	58	8.5
BLRTSX160i-HA	1/4 M/Hex	1/4 F/Hex	101	28	52	58	28
BLRTSX160i-A	1/4 F/Sq	1/4 M/Sq	75	28	52	58	8.5
BLRTSX36F-A	3/8 F/Sq	3/8 M/Sq	101	38	58	59	21.5
BLRTSX73F-A	1/2 F/Sq	1/2 M/Sq	106	38	58	59	26
BLRTSX118F-A	1/2 F/Sq	1/2 M/Sq	106	38	58	59	26
BLRTSX184F-A	3/4 F/Sq	3/4 M/Sq	135	58	76	64	40
BLRTSX368F-A	3/4 F/Sq	3/4 M/Sq	135	58	76	64	40
BLRTSX738F-A	1 F/Sq	1 M/Sq	177	73	90	73	57.5

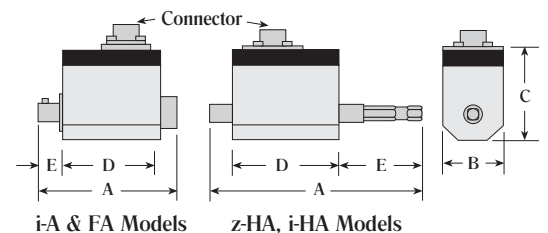

Threads for mounting M4, 6mm depth.

# BLRTSX

## Brushless Rotary Torque Sensor with ARC II Technology

Model	Item #	Torque Ranges	
		American	S.I.
BLRTSX28z-H	170225	10 - 28 ozf.in	7 - 20 cN.m
BLRTSX70z-H	170226	10 - 70 ozf.in	7 - 49 cN.m
BLRTSX140z-H	170227	25 - 140 ozf.in	18 - 98.8 cN.m
BLRTSX18i-H	170228	2 - 18 lbf.in	22.5 - 203 cN.m
BLRTSX50i-H	170229	5 - 50 lbf.in	56.5 - 565 cN.m
BLRTSX50i	170230	5 - 50 lbf.in	56.5 - 565 cN.m
BLRTSX100i-H	170231	10 - 100 lbf.in	113 - 1130 cN.m
BLRTSX100i	170232	10 - 100 lbf.in	113 - 1130 cN.m
BLRTSX160i-H	170233	16 - 160 lbf.in	180 - 1807 cN.m
BLRTSX160i	170234	16 - 160 lbf.in	180 - 1807 cN.m
BLRTSX18F	170235	2 - 18 lbf.ft	2.5 - 25 N.m
BLRTSX36F	170236	4 - 36 lbf.ft	5 - 50 N.m
BLRTSX73F	170237	8 - 73 lbf.ft	10 - 100 N.m
BLRTSX118F	170238	12 - 118 lbf.ft	16 - 160 N.m
BLRTSX184F	170239	19 - 184 lbf.ft	25 - 250 N.m
BLRTSX368F	170240	37 - 368 lbf.ft	50 - 500 N.m
BLRTSX738F	170241	74 - 738 lbf.ft	100 - 1000 N.m

### DRIVE SIZE

Model	Input	Output
BLRTSX28z-H	1/4 Male/Hex	1/4 Female/Hex
BLRTSX70z-H	1/4 Male/Hex	1/4 Female/Hex
BLRTSX140z-H	1/4 Male/Hex	1/4 Female/Hex
BLRTSX18i-H	1/4 Male/Hex	1/4 Female/Hex
BLRTSX50i-H	1/4 Male/Hex	1/4 Female/Hex
BLRTSX50i	1/4 Female/Square	1/4 Male/Square
BLRTSX100i-H	1/4 Male/Hex	1/4 Female/Hex
BLRTSX100i	1/4 Female/Square	1/4 Male/Square
BLRTSX160i-H	1/4 Male/Hex	1/4 Female/Hex
BLRTSX160i	1/4 Female/Square	1/4 Male/Square
BLRTSX18F	3/8 Female/Square	3/8 Male/Square
BLRTSX36F	3/8 Female/Square	3/8 Male/Square
BLRTSX73F	1/2 Female/Square	1/2 Male/Square
BLRTSX118F	1/2 Female/Square	1/2 Male/Square
BLRTSX184F	3/4 Female/Square	3/4 Male/Square
BLRTSX368F	3/4 Female/Square	3/4 Male/Square
BLRTSX738F	1 Female/Square	1 Male/Square

 **CERTIFIED**  
Supplied with Free ISO 17025 Certification of Calibration.

 **PLUG & PLAY**

### NOTE!

\*This is the "stand alone" accuracy for the torque sensor. When the sensor is coupled with a Mountz torque analyzer, there is a system accuracy. Review the system accuracy listed with each torque analyzer.

### SPECIFICATIONS

Rated Output: $\pm 5\text{VDC} \pm 0.2\% \text{ FS}$
Excitation Recommended: 11VDC to 26VDC (pole secure)
Nonlinearity: $\pm 0.2\% \text{ FS}$
Usable Temperature Range 41 - 122°F
Mating Connector: Tuchel Series 581 (98-2030-09-12)
Safe Overload: 150% of Rated Output



TORQUE SENSORS

### KEY FEATURES

Accuracy  $\pm 0.2\%$  of full scale\*.

Non-contact signal transfer and maintenance free.

The common "brush bounce" that plagues the accuracy testing of pulse tools is cured when using a BLRTSX.

Bi-directional.

Compact design.

For use with most power tools, high RPM tools, or rotational measurement applications.

Features "ARCII" technology, an instant auto-recognition system of the BLRTSX connected to the PTT or LTT.



### BLRTSX CABLE

**Item #072001**  
For connecting to PTT or LTT

### CONNECTION

A = Ground  
(Shunt Calibration)  
C = Torque Output  
D = Ground (Torque Output)  
E = Ground (Supply)  
F = Supply, 11-26 VDC, 1 W  
K = Shunt Calibration  
M = Shield  
B/G/H/J/L = N/A

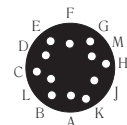

### DIMENSIONS

Model	A	B	C	D	E
BLRTSX28z-H	101	28	52	58	28
BLRTSX70z-H	101	28	52	58	28
BLRTSX140z-H	101	28	52	58	28
BLRTSX18i-H	101	28	52	58	28
BLRTSX50i-H	101	28	52	58	28
BLRTSX50i	75	28	52	58	8.5
BLRTSX100i-H	101	28	52	58	28
BLRTSX100i	75	28	52	58	8.5
BLRTSX160i-H	101	28	52	58	28
BLRTSX160i	75	28	52	58	8.5
BLRTSX18F	74.5	38	58	44	18
BLRTSX36F	74.5	38	58	44	18
BLRTSX73F	79	38	58	44	22.5
BLRTSX118F	79	38	58	44	22.5
BLRTSX184F	97	58	76	50	30
BLRTSX368F	97	58	76	50	30
BLRTSX738F	112	73	90	57	34.5

### i & F Models z-H, i-H Models

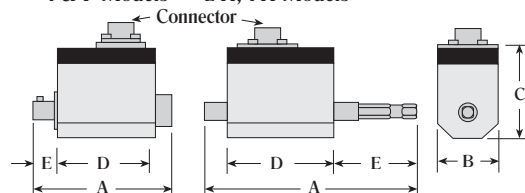

# SDX

## Torque Screwdriver Sensor with ARCII Technology

### KEY FEATURES - SDX

Accuracy  $\pm$  0.25% of full scale\*.

Torque sensor for auditing or tightening fasteners to a specified torque when mated with a torque analyzer.

Ergonomic rubber grip and stainless steel Female/Hex bit holder.

Features "ARCII" technology, an instant auto-recognition system of the SDX connected to the FTA-100, PTT or LTT.

Connect to a torque analyzer to monitor, test or audit a fastener.

Safe Overload: 125% of Rated Output.

Model	Item #	Torque Ranges	
		American	S.I.
SDX10i	078000	1 - 10 lbf.in	11.3 - 113 cN.m
SDX50i	078001	5 - 50 lbf.in	56.5 - 565 cN.m

Model	Drive Size	Length	Width	Weight
SDX10i	1/4" Female/Hex	6"	1 1/2"	0.5 lbs.
SDX50i	1/4" Female/Hex	6"	1 1/2"	0.5 lbs.



CONNECT WITH A:



#### LTT

Connect to a torque analyzer to monitor, test or audit a fastener.  
SEE PAGE O1.3



#### CERTIFIED

Supplied with Free ISO 17025 Certification of Calibration.



#### PLUG & PLAY



#### NOTE!

\*This is the "stand alone" accuracy for the torque sensor. When the sensor is coupled with a Moutz torque analyzer, there is a system accuracy. Review the system accuracy listed with each torque analyzer.



#### Moutz Torque Conversion Calculator

Quickly convert torque measurement from one type of unit measurement to another. Visit [www.moutztorque.com/calculator](http://www.moutztorque.com/calculator)



#### Moutz Tool Selector

Easy to navigate, a guide that assists engineers in selecting the proper tool for the application. Visit [www.moutztorque.com/torque-tool-selector](http://www.moutztorque.com/torque-tool-selector).

### CABLE - SDX

#### Item #072004

For connecting to FTA-100, PTT or LTT

#### SDX CONNECTION

- A = Signal (+)
- B = Signal (-)
- C = Excitation (-)
- D = Excitation (+)
- E/F = N/A



### CABLE - ETX

#### Item #072006

For connecting to FTA-100, PTT or LTT

#### ETX CONNECTION

- A = Signal (-)
- B = Signal (+)
- C = Excitation (-)
- D = Excitation (+)
- E = Memory Circuit Digital Clock
- F = Memory Circuit Digital I/O



# ETX

## Torque Wrench Sensor with ARCII Technology

### KEY FEATURES - ETX

Accuracy  $\pm$  1% of full scale.

Designed for monitoring, testing, and auditing fasteners.

Can be used for "Just Move" and "Breakaway" torque tests.

Bi-directional.

Non-length dependent.

Robust design and fixed head.

Safe Overload: 125% of Rated Output.

Features "ARCII" technology, an instant auto-recognition system of the ETX connected to the FTA-100, PTT or LTT.

Model	Item #	Torque Ranges	
		American	S.I.
ETX10	020176	9 - 89 lbf.in	1 - 10 N.m
ETX30	020177	2.5 - 22 lbf.ft	3 - 30 N.m
ETX100	020178	8 - 75 lbf.ft	10 - 100 N.m
ETX300	020179	22 - 220 lbf.ft	30 - 300 N.m

Model	Square Drive	Length	Width	Weight
ETX10	1/4"	8 1/2"	1 1/4"	9 oz.
ETX30	1/4"	8 1/2"	1 1/4"	9 oz.
ETX100	3/8"	17 1/2"	1 5/8"	1.5 lbs.
ETX300	1/2"	26"	2"	2.4 lbs.

Calibrated Dead Weights are the official means by which torque analyzers and transducers are traced to the National or International Standards such as NIST, ISO, and others. There are 3 components that compose of a Dead Weight Test Set: (1) Segment Arm or Wheel, (2) Hanger, and (3) Weights.

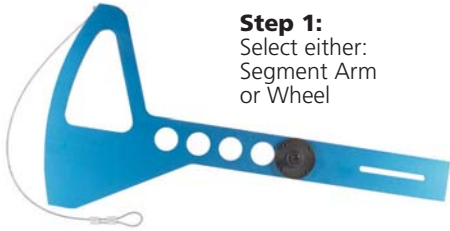

**Step 1:**  
Select either:  
Segment Arm  
or Wheel

**SEGMENT ARMS**

Model	Item #	Max Wt.	Tolerance	Input Dr.	Length
S-10	061106	25 lbs.	±.005	1/4"	10"
S-10	060094	75 lbs.	±.005	3/8"	10"
S-10	060056	100 lbs.	±.005	1/2"	10"
S-12	060052	75 lbs.	±.006	3/8"	12"
S-12	060093	100 lbs.	±.006	1/2"	12"
S-24	060091	125 lbs.	±.012	1/2"	24"
S-24	060053	250 lbs.	±.012	3/4"	24"
S-48	060090	125 lbs.	±.024	3/4"	48"
S-48	060054	300 lbs.	±.024	1"	48"

**WHEELS** (pictured upper right photo)

Model	Item #	Max Wt.	Tolerance	Input Dr.	Radius
1.0*	061587	50 oz.	±.0005	1/4"	1"
2.0**	060095	20 lbs.	±.001	1/4" & 3/8"	2"
4.0**	060064	65 lbs.	±.002	1/4" & 3/8"	4"

\*Shape: Circular \*\*Shape: Butterfly

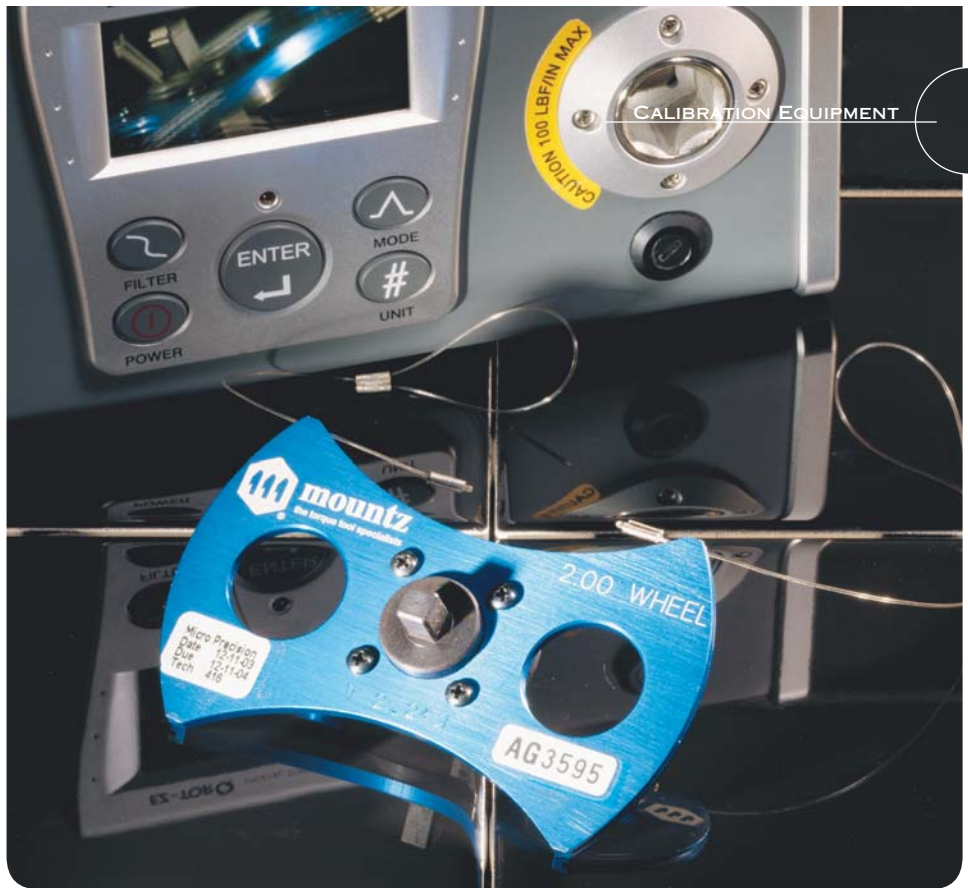

# Calibration Test Equipment

For Torque Analyzers & Torque Sensors

**Step 2:** Select Hanger

Model	Item #	Weight	Stem
Stainless Steel (Class F)	110044	2 lbs.	9 1/4"
Stainless Steel (Class F)	110043	5 lbs.	16"



**Step 3:** Select Weights



Hook Weight



Slotted Weight



Hanger

Model	Item #	Weight
Stainless Steel Hook (Class 3)	110050	0.25 oz.
Stainless Steel Hook (Class 3)	110051	0.50 oz.
Stainless Steel Hook (Class 3)	110052	1 oz.
Stainless Steel Hook (Class 3)	110053	2 oz.
Stainless Steel Hook (Class 3)	110054	4 oz.
Stainless Steel Hook (Class 3)	110055	8 oz.
Stainless Steel Hook (Class 3)	110056	16 oz.
Stainless Steel Hook (Class 3)	110057	32 oz.
Stainless Steel Hook (Class 3)	110058	40 oz.
Stainless Steel Slotted (Class F)	110047	0.5 lbs.
Stainless Steel Slotted (Class F)	110046	1 lb.
Stainless Steel Slotted (Class F)	110045	2 lbs.
Stainless Steel Slotted (Class F)	110041	5 lbs.
Stainless Steel Slotted (Class F)	110042	10 lbs.
Stainless Steel Slotted (Class F)	110070	20 lbs.
Stainless Steel Slotted (Class F)	110071	50 lbs.



**TOTAL WEIGHT**

Weights are placed upon the Hanger, which is hung from the Segment Arm or Wheel. The amount of **total weight** needed is determined by the maximum torque range of the analyzer or sensor being calibrated and the length of the Segment Arm or Wheel.

**NOTE!**

**Total weight** includes both the Hanger and the Stainless Steel Weight(s).

# Loading Bench

Calibrating Wrenches



**LB750F**  
(BMX Torque Sensor not included)

## KEY FEATURES

A calibration system designed to ensure accurate calibration of torque wrenches.

The laboratory grade instrument assures accurate torque calibration and pre-setting, independent of human influence or transducer side and end load factors.

The drive system assures the load application, eliminating the operator induced test error.

Built for durable use, the Loading Bench reduces the operator effort required to attain and sustain torque during the calibration process.

Large wheel for smooth manual loading.

Operates in both clockwise and counterclockwise directions.

Models that range from 0 - 2000 lbf.ft

Use with a Mountz BMX torque sensor and torque analyzer.

Mountable for bench or a cabinet.

Adjustable to fit the size of wrench being tested. Load applied easily and slowly for accurate calibration.

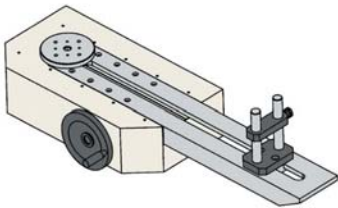

## LB250F

Torque Range: Max. 250 lbf.ft (3000 lbf.in).

Reaction Position:

Horizontally: 4" to 28" from the center of the turn-table.

Vertically: 1" to 4" from the turn-table base.

Weight: 53 lbs.

Size: 37.5" W x 12" H x 10.75" D

Item #063302

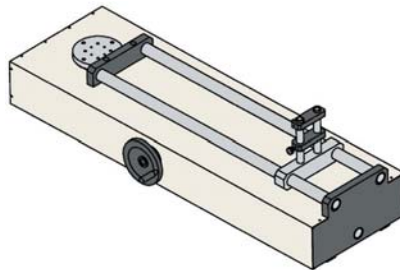

## LB750F

Torque Range: Max. 750 lbf.ft (9000 lbf.in).

Reaction Position:

Horizontally: 4.87" to 41.25" from the center of the turn-table.

Vertically: 1.87" to 5.4" from the turn-table base.

Weight: 130 lbs.

Size: 50" W x 15" H x 15.5" D

Item #063301

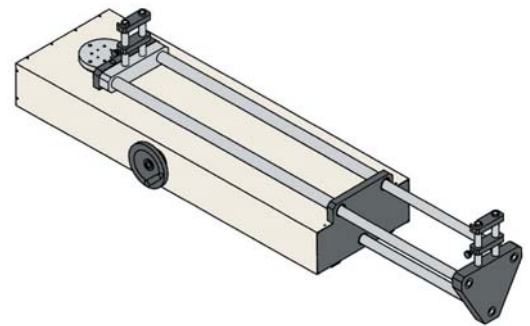

## LB2000F

Torque Range: Max. 2000 lbf.ft (24000 lbf.in).

Reaction Position:

Horizontally: 4.87" to 75.5" from the center of the turn-table.

Vertically: 1.87" to 5.4" from the turn-table base.

Weight: 160 lbs.

Size: 84.75" W x 15" H x 15.5" D

Item #063300



## NOTE!

It is recommended that the Loading Bench be fastened to a bench top.

**mr.  
metric**<sup>®</sup>

Mr. Metric is the leading metric fastener specialist in North America. Well regarded as experts in metric. Mr. Metric is known for hard to find metric items at competitive prices. Visit [www.mrmetric.com](http://www.mrmetric.com)



## BMX TORQUE SENSOR

For calibrating manual or power tools or special applications.

A wide torque range selection, from 2 ozf.in to 20,000 lbf.ft.

SEE PAGE O1.8



# Run Down Adapters

Torque Analyzers and Sensors



## AURA ADAPTER (Auto Reversing Run Down Adapter)

Ideal for testing and recording the results of power tools with a torque analyzer or sensor. Not recommended for pulse tools.

Operates in clockwise direction only. Once the tool shuts off, the AURA automatically unwinds for the next run down. Eliminates the need to back it out.

Designed to provide consistent and reliable torque readings for use with power driven torque control tools.

Adapter is mounted in-line between tool drive and the torque sensor.

Compact size and lightweight.

Includes two springs to cover the torque range 1 - 50 lbf.in

Model	Item #	Torque Ranges		Drive Output	Drive Input
		Light Spring	Heavy Spring		
AURA	063292	1 - 25 lbf.in	25 - 50 lbf.in	17mm Hex	1/4" F/Sq.
AURA	063293	1 - 25 lbf.in	25 - 50 lbf.in	1/4 M/Sq.	1/4" F/Sq.



## MINI RUN DOWN ADAPTERS

The mini RDA unit with fastener is designed for low torque sensors (BMX20z - BMX10i and MTX models).

Designed to provide consistent and reliable torque readings for use with low torque power tools.

The mini RDAs allow a close simulation of actual joints.

Adapter is mounted in-line between tool drive and the torque sensor.

Operates in clockwise direction only.

The kit includes 5 mini RDA units along with 10 fasteners.

Model	Item #	Screws
Mini RDA2	061229-2	PH Phil 2-56 x 1/4 SS
Mini RDA4	061229-4	PH Phil 2-56 x 1/4 SS
Mini RDA6	061229-6	PH Phil 2-56 x 1/4 SS

## NOTE!

Change screws when thread wear occurs.  
(Recommended - approximately every 25 run downs).

## SPRING RUN DOWN ADAPTERS for EZ-TorQ

Designed to provide consistent and reliable torque readings for use with power driven torque control tools.

Adapter is mounted in-line between tool drive and a transducer.

Compact size and lightweight.

Operates in clockwise direction only.

Compatible with only the EZ-TorQ Analyzer.



Model	Item #	Torque Ranges		Drive Input	Drive Output
		lbf.in	cN.m		
RDA	070600	1 - 10	11.3 - 113	5mm Hex	17mm Hex
RDA	070605	5 - 50	56.5 - 565	6mm Hex	17mm Hex
RDA	070610	10 - 100	113 - 1130	6mm Hex	17mm Hex
RDA	070615	15 - 150	169.5 - 1695	6mm Hex	17mm Hex

## RUN DOWN ADAPTERS

Designed to provide consistent and reliable torque readings for use with power driven torque control tools.

Adapter is mounted in-line between tool drive and the torque sensor.

Hardened thread components increase accuracy and life.

Square drives conform to ASME B107 standards for proper fit.

Non-rotating body for improved safety.

Compact size and lightweight.

Operates in clockwise direction only. After each run down, the RDA should be completely backed-up.



Model	Item #	Torque Ranges		Sq. Drive
		American	S.I.	
RDA-10i	063970	1 - 10 lbf.in	11.3 - 113 cN.m	1/4"
RDA-25i	063971	2 - 25 lbf.in	28 - 282.5 cN.m	1/4"
RDA-50i	063972	5 - 50 lbf.in	56.5 - 565 cN.m	1/4"
RDA-100i	063973	10 - 100 lbf.in	113 - 1130 cN.m	1/4"
RDA-250i	063974	25 - 250 lbf.in	282.5 - 2825 cN.m	1/4"
RDA-50F	063978	5 - 50 lbf.ft	6.8 - 67.8 N.m	3/8"
RDA-750i	063977	75 - 750 lbf.in	847 - 8473 cN.m	3/8"
RDA-100F	063981	10 - 100 lbf.ft	13.6 - 135.6 N.m	1/2"
RDA-250F	063982	25 - 250 lbf.ft	33.9 - 339 N.m	1/2"
RDA-500F	063983	50 - 500 lbf.ft	67.8 - 678 N.m	3/4"
RDA-1000F	063991	100 - 1000 lbf.ft	135.6 - 1355 N.m	1"
RDA-2500F	063990	250 - 2500 lbf.ft	339 - 3389 N.m	1 1/2"
RDA-5000F	063992	500 - 5000 lbf.ft	678 - 6779 N.m	1 1/2"

# Accessories

## Torque Analyzers and Torque Sensors



### ROTARY FIXTURE CALIBRATION STAND

The stand keeps the rotary sensor in a stable position for the calibration process.

Supplied with Pin Adapters and In/Out Adapters.

Calibration Wheel(s), Hanger(s), Weight(s), and a Torque Analyzer are required for calibration of a rotary sensor. See Page 01.14

#### IN/OUT ADAPTERS

#### PIN ADAPTERS

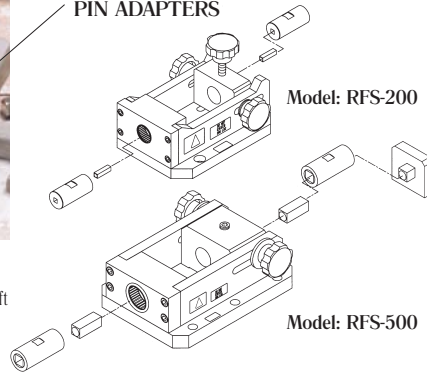

**Model: RFS-200**  
Torque Range: 1 - 200 lbf.in  
Dimensions:  
5 1/2" x 7 1/4" x 2 3/4"  
Item #060234

**Model: RFS-500**  
Torque Range: 5 - 500 lbf.ft  
Dimensions:  
8" x 11" x 4 1/4"  
Item #062032



### BAR CODE READER for LTT and PTT

Item #072997

Designed to scan Bar Codes on tools and start Tool Tests automatically.

Reduces operational time for users with a large number of Tool Tests stored in the analyzer.

The PTT or LTT are designed to work with this bar code reader.



### MULTIPLEXER for LTT and PTT

Item #072998

Size (W x L x H):  
6 3/4" x 6 3/4" x 1 3/8"  
Weight: 1.3 lbs.

Connects 1-4 sensors to the Torque Analyzer and switches between the sensors manually or automatically.

Eliminates the need to plug and unplug sensors.

When the PTT or LTT is connected to the Multiplexer it reviews the Multiplexer (Mux) to determine what sensors are connected and downloads the identity and calibration data for each of the attached sensors.

### MOUNTING BRACKETS for LTT Torque Analyzer



Item #072608  
For LTT Model: 10i-50F



Item #072606  
For All LTT Models

### CALIBRATION HEX STEP ADAPTERS

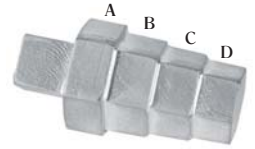

1/4" SQUARE DR.

Model	Item #	Dimensions			
		A	B	C	D
American	061500	3/4"	11/16"	5/8"	9/16"
American	061501	1/2"	7/16"	3/8"	5/16"
American	061527	1/2"	3/8"	1/4"	1/8"
American	061502	1/4"	7/32"	3/16"	1/8"
Metric	061503	19mm	17mm	16mm	14mm
Metric	061504	13mm	12mm	11mm	10mm
Metric	061505	9mm	8mm	7mm	6mm
Metric	061529	9mm	7mm	5mm	3mm
Metric	061528	8mm	6mm	4mm	2mm
Metric	061506	5.5mm	5mm	4.5mm	4mm

3/8" SQUARE DR.

Model	Item #	Dimensions			
		A	B	C	D
American	061537	1"	7/8"	3/4"	5/8"
American	061524	3/4"	11/16"	5/8"	9/16"
American	061531	9/16"	7/16"	5/16"	3/16"
American	061525	1/2"	7/16"	3/8"	5/16"
American	061530	1/4"	7/32"	3/16"	1/8"
Metric	061543	19mm	17mm	16mm	14mm
Metric	061542	17mm	15mm	13mm	11mm
Metric	061541	16mm	14mm	12mm	10mm
Metric	061540	13mm	12mm	11mm	10mm
Metric	061539	9mm	8mm	7mm	6mm
Metric	061538	5.5mm	5mm	4.5mm	4mm

### MOUNTING BRACKETS

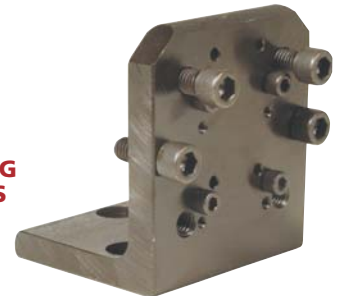

**Model: MB-1**  
Works with:  
BMX20z - BMX500F  
MTX 10z - 160z  
All EZ-TorQ Models  
Dimensions: 4" x 3" x 4"  
Item #062109

**Model: MB-3**  
Works with:  
BMX1000F - BMX5000F  
Dimensions: 8" x 7 7/8" x 8"  
Item #062128



A BMX torque sensor is securely mounted for calibrating a torque wrench using a Mounting Bracket. Keeping the sensor in a stable position ensures the accuracy of the torque measurement during operation.

# Torque Measurement and Calibration

## TORQUE MEASUREMENT

Torque tools go out of calibration with use. To maintain consistent accuracy, torque tools must be checked periodically for wear or defective parts. A power or hand torque tool is a measuring tool that must be properly calibrated and maintained. Regular torque calibration and re-calibration guarantees repeatable accuracy and adherence to international standards. Torque testing also ensures torque equipment is operating to peak performance and can highlight potential tooling problems before they arise perhaps due to tool wear or broken components.

Controlling torque is essential for companies to ensure their product's quality, safety and reliability isn't compromised. The failure of a three-cent fastener that isn't properly tightened can lead to catastrophic or latent failures. Fasteners that are insufficiently torqued can vibrate loose and excessive torque can strip threaded fasteners. Torque measurement should occur in three facets of the assembly process: 1) Prior to Assembly 2) During Assembly 3) After Assembly.

A torque analyzer or a torque sensor are a finely tuned instrument designed for testing and monitoring torque applications. Designed for torque evaluation and verification, a torque analyzer and sensor are a laboratory grade instruments commonly used for quality control, R&D and calibration applications. These instruments can be used to calibrate or test hand screwdrivers, pneumatics screwdrivers, torque wrenches, electric screwdrivers, pulse tools, cordless screwdrivers, torque multipliers and other torque tools. Using a quality torque tester or sensor are key for many companies to ensure that the proper torque is being applied. Testing torque is literally a science and not something that can be left to chance.

## CERTIFICATION EXPLANATION



### Header

Identifies name and location of laboratory issuing certificate, as well as certificate number.

### Equipment Tested

Easy identification of tool type, maximum capacity, serial number, and accuracy. Also indicates arrival condition of tool, service performed, calibration date, interval, and due date.

### Standards Used

Identifies procedure and equipment used to perform the calibration, as well as test accuracy ratio.

### Certification

Section for approval of certificate content by authorized signatories. Also includes statement of compliance with relevant calibration standards and NIST-Traceability.

## CALIBRATION INTERVALS

A tool must be properly calibrated and maintained on a preventative maintenance and calibration schedule. In order to maintain accuracy, it is crucial that a torque tool and measuring equipment be calibrated regularly. Some organizations may recommend six (6) month calibration intervals, while others may schedule it at twelve (12) months. However, it is the organization that owns the tool that must determine a suitable calibration frequency that meets their needs based upon many factors, such as history of equipment performance, application, degree of usage, and management objectives.

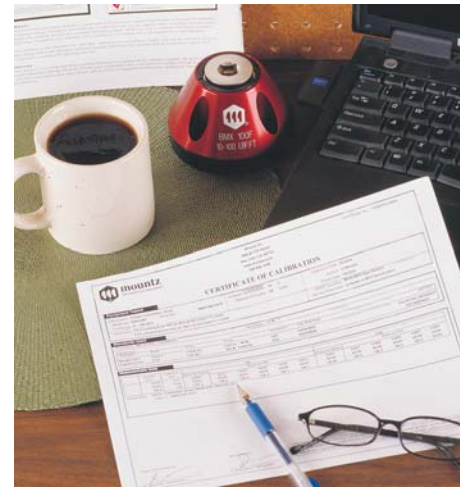

## CERTIFICATION

All Mountz torque analyzers and sensors are supplied with a **Free** ISO 17025 Certification of Calibration.



## CERTIFICATE OF CALIBRATION

This symbol identifies the products that are supplied with a **Free** ISO 17025 Certification of Calibration.

## Quality Standards

To meet customer requirements, we begin with compliance to stringent, world-class quality standards.

- Mountz is an ISO 9001 certified and ISO 17025 accredited company.
- Design and testing of all hand tools conforms to requirements of ISO 6789, as specified.
- Laboratory operations and calibrations meet the requirements of ANSI/NCSL Z540-1.

## Calibration Services

Mountz Inc. features an experienced calibration and repair staff. Our trained technicians can calibrate and repair most any tool. Mountz provides rapid service with quality that you can trust as we offer two state-of-the-art calibration lab and repair facilities that can calibrate up to 20,000 lbf.ft. All calibrations are performed using NIST-Traceable standards, and meet the requirements of ANSI/NCSL Z540.



### HAND TORQUE TOOL CATALOG

(40 Page - Available in Print or PDF format)  
 Torque Screwdrivers  
 Torque Wrenches  
 Accessories



### POWER TORQUE TOOL CATALOG

(56 Page - Available in Print or PDF format)  
 Electric Torque Screwdrivers  
 Pneumatic Torque Screwdrivers  
 Cordless Torque Screwdrivers  
 Pulse Tools  
 Torque Arms  
 Screw Counters  
 Accessories



### TORQUE MULTIPLIER CATALOG

(24 Page - Available in PDF format only)  
 Hand Torque Multipliers  
 Pneumatic Torque Multipliers  
 Electric Torque Multipliers  
 Accessories



**mountz**  
 the torque tool specialists

#### CORPORATE HEADQUARTERS

1080 North 11th Street  
 San Jose CA 95112  
 t 408.292.2214  
 t 800.456.1828  
 f 408.292.2733  
 sales@mountztorque.com  
 www.mountztorque.com

#### DISTRIBUTION & SERVICE CENTER

19051 Underwood Road  
 Foley AL 36535  
 t 251.943.4125  
 f 251.943.4979

#### US & CANADA SALES OFFICES

Anaheim, Birmingham, Boston,  
 Charlotte, Chicago, Cleveland,  
 Dallas, El Paso, Los Angeles,  
 Nashville, Seattle, San Jose,  
 Toronto

#### MEXICO SALES OFFICES

Tijuana, Cd. Juarez, Chihuahua,  
 Reynosa, Monterrey,  
 Mexico DF, Guadalajara



sales@mountzpro.com  
 www.mountzpro.com

MountzPro, a new division of Mountz, Inc., focuses exclusively on the automotive professionals market. MountzPro also features "At the Track", a daily "car show" blog. The online virtual car show allows all car enthusiasts to share and display pictures of their car and how they've modified their ride.

Share your ride:  
<http://onlinecarshow.mountzpro.com/>

#### FOLLOW MOUNTZ

Keep informed about our torque tool products, events and industry news. Select your favorite social media site to catch the latest news from Mountz.

Twitter: @mountztorque  
 Facebook: [www.facebook.com/mountztorquetool](http://www.facebook.com/mountztorquetool)  
 YouTube: [www.youtube.com/MountzTorque](http://www.youtube.com/MountzTorque)  
 Mountz Blog: [www.mountztorque.com/blog](http://www.mountztorque.com/blog)  
 LinkedIn: [www.linkedin.com/company/mountz-inc](http://www.linkedin.com/company/mountz-inc)  
 Google Plus: [plus.google.com/+Mountztorque/posts](http://plus.google.com/+Mountztorque/posts)



Twitter



Facebook



YouTube



Blog



LinkedIn



Google Plus



sales@mrmetric.com  
 www.mrmetric.com

Mr. Metric is the leading metric fastener specialist in North America. Well regarded as experts in metric. Mr. Metric is known for hard to find metric items at competitive prices.