

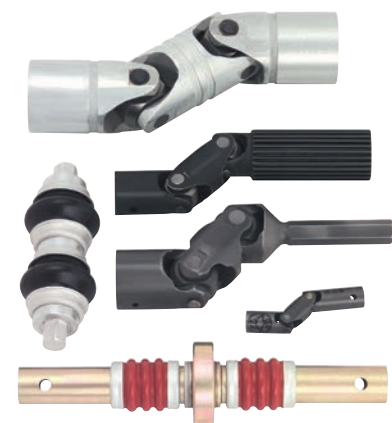

300 Series
Pages 10-11



400 Series
Pages 12-13



Double UJ's
Pages 14-15



**Quick-Change/
Telescopic**
Pages 16-17



**Military Standard
MS20270**
Page 18



**Military Standard
MS20271**
Page 19



Needle Bearing UJ's
Page 21

Overview 4-9

Apex 300 Series Universal Joints . . . 10-11

Apex 400 Series Universal Joints . . . 12-13

Apex Double Universal Joints 14-15

Apex Quick-Change/Telescopic
Universal Joints 16-17

MS20270 Universal Joints 18

MS20271 Universal Joints 19

MS Series Deflection Curves 20

Needle Bearing Universal Joints 21

Instructions to Calculate

Correct Joint Size 22

Custom Application Sheet 23

Less Downtime, More Lifetime.

Apex has been supplying universal joints for military and commercial applications since 1933. Over these 70+ years we have provided engineered solutions for thousands of demanding applications worldwide. Today Apex is recognized as the **"Less downtime, more Lifetime"** leader in pin and cube universal joint designs and applications. Our primary markets are:

Government/Military Applications

Apex meets the demanding requirements military applications such as gun systems, remote valve control, Unmanned Aerial Vehicles (UAV), thrust vector control systems, and fan drive universal joints.



Aerospace

Commercial, military, business jets, and private aircraft all utilize Apex universal joints. Typical uses include flap/slat actuation, "hinges" for cargo doors and windows, mechanical linkages for steering, trim control and door latching mechanisms. Apex double universal joints have even been used to replace gear boxes. These high strength-to-weight ratio universal joints have excellent torsional freeplay (i.e., backlash) characteristics suited to this environment.



Off-highway/ Construction Equipment

Applications include steering columns, a variety of mechanical linkages and power take offs. Also included are custom designs for specialty equipment (e.g. fire trucks.)



Performance Racing

Our MS series of universal joints have become the standard by which all other universal joints are measured. The same aerospace design considerations are applicable in this competitive market. Primary uses are for steering, shift linkages, and chassis adjustment applications.

Industrial Power Transmission

This represents the most diverse area of applications. Some typical uses are steel leveling equipment, links to conveyor systems, pump drive systems, multiple spindle drill heads, bowling alley pin setters, canning equipment, centerless grinders, bottling machines, industrial sewing machines, control linkages, mixing equipment, packaging machinery, and industrial scales. This list represents only a fraction of the applications where Apex universal joints are used. Our “quick-change” universal joints are extremely popular in this area. They eliminate precision alignment requirements and allow for quick repair of critical machinery and assembly/conveyor lines.

Apex universal joints consistently deliver performance in process industries where continuous operation is the norm and equipment availability/uptime is critical.

Whatever your application, you can depend on Apex universal joints to provide rigidity and exceptionally high strength-to-weight ratios with less deflection, superior fatigue resistance and high overload capacity. Add to this Apex’s wide selection of elastomeric covers that seal lubrication in and protect the universal joint from harsh operating environments (e.g., dirt, water, abrasive slurry, etc.), and you have unsurpassed reliability for your application. All of these features can be incorporated into single, double, telescopic, or quick-change universal joints. We specialize in make-to-order products engineered to optimize your application and reduce operating costs. Apex is the Performance Authority for pin-and-cube universal joints.



Apex Offers A Variety of Solutions For Your Standard or Custom Application

If your application calls for something other than our standard 300 or 400 series universal joints, Apex can provide it for you. Our engineers are ready to solve your application problems. Some of the options available are:

Universal Joint Configurations:

In addition to the standard plain bearing design, there is also a “Press Fit” design which improves fatigue life in reverse loading applications. For higher RPMs, we offer a needle bearing line.

Materials:

Alloy steels (4140, 4150, 4340), Austenitic stainless steel (303, 304, 316, Nitronic 60), Martensitic stainless steel (416, 440C, 13-8, 17-4, 15-5), carbon steel (1020, 8620) and specialty steels (such as Stressproof and S-2 Modified).

Bearings:

Apex utilizes plain, rolling element and polymer bearings in its designs. Selecting the right bearing maximizes the performance the universal joint, minimizes/eliminates maintenance, and increases the life of the universal joint.

Heat Treatment:

Apex proprietary heat treat, selective through hardening, induction hardening, and case hardening.

Surface Treatment:

Light oil, cadmium (electrolytic and vacuum), electrolytic zinc, nickel (electrolytic and electroless), black oxide, phosphate (manganese and zinc), solid film lubricant, and a variety of paint solutions.

Cover Materials:

Silicone, Nitrile, EPDM, Viton, Neoprene, FDA approved food polymer, vinyl, Silicon/Dacron, Fluoro-Silicon/Nomex.

Cover Styles:

Bulbous, flat, and convoluted.

Lubricants:

High pressure gear oil, “natural” grease, synthetic grease, synthetic grease with additives (improves “dry start” characteristics), non-outgassing grease, food grade grease, graphite powder, and solid film lubricant.

Geometry:

Square, Hex, Threaded, splines (involute or straight-sided), gears, split collar with lug bolt, keyways, precision diameters (.0002”), gears, whistle-notch, and quick-release. Where applicable, these are available in male or female.



Additionally, multiple features can be combined on the same hub. Apex engineers utilize these options daily to design the product right for your needs. From extreme loading (including seismic) to harsh environments (-80° to 600° F), Apex is your Total Solution Source.

Quality

Apex universal joints are supplied from our Dayton facility which has AS9100 certification. AS9100 is a widely adopted and standardized quality management system for the aerospace industry and incorporates fully the entirety of the current version of ISO 9001.



Our Dayton facility, manufacturing site of Apex Universal Joints, has AS9100 Quality System Certification. The driving force behind the implementation of the Quality System is the commitment “to provide our customers with the best value delivered by offering only products and services that meet or exceed their expectations.”

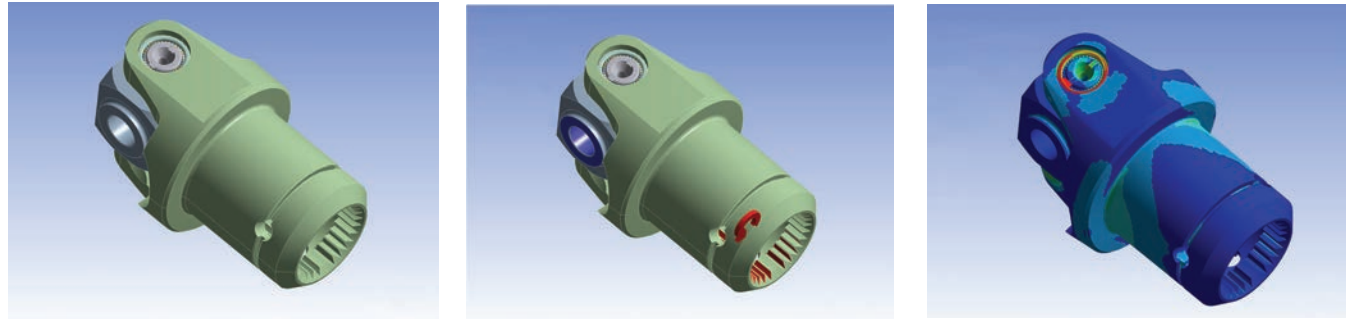

Apex design engineers utilize 3-D solid models and finite element analysis (FEA) to develop and evaluate different design options.

The Apex Total Solution Designed Into Every Universal Joint

The illustration below highlights many of the common design features that have made Apex the Market Leader in providing **“less downtime, more lifetime”** for some of the most demanding applications. At the heart of this success is engineering excellence that created and continues to refine this design to meet the ever increasing challenges of new applications. To further compliment this, add Apex’s manufacturing capabilities and its proprietary heat-treat processes. The result is a “balanced” design that provides the highest strength-to-weight ratio pin and cube universal joint available. It is not uncommon for Apex to outperform the competition by at least 30% in strength for equivalent size products.

When you bring your applications to Apex, you will be supported by a technical staff that has the in-house capability to perform Finite Element Analysis (FEA), 3-D Solid Modeling, Metallurgical analysis, non-destructive testing, functional testing, and prototype production.

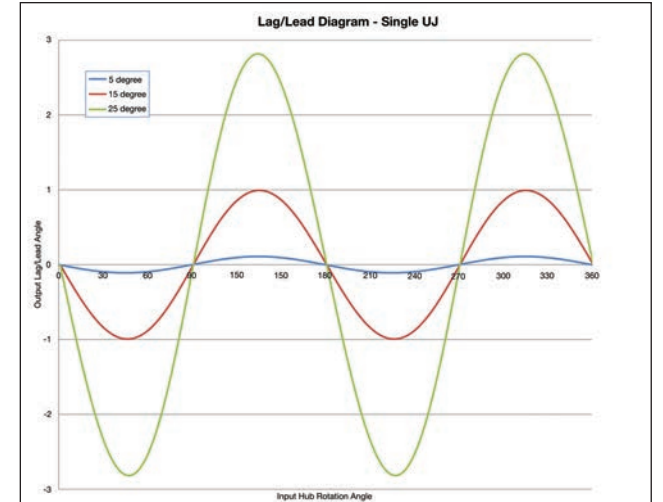
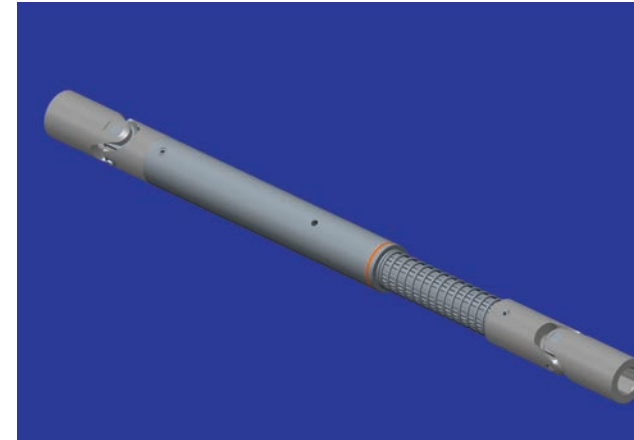
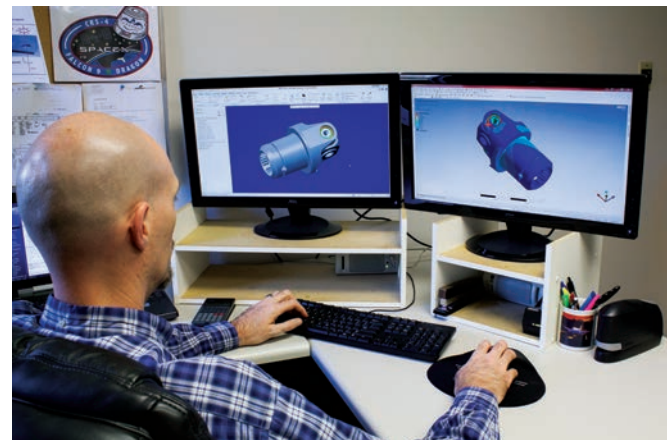

The most useful tool, however, is the knowledge gained from providing application solutions for over 60 years. Use the application sheet at the back of this catalog to find out how Apex universal joints can improve the performance of your application.

Short delivery times required for replacement parts or product development samples can be produced in the “Short Run Cell”.

This cell has all of the manufacturing capability to produce almost any configuration universal joint

in an expedited manner. A single machinist takes ownership of the job and is responsible for it from production to final assembly. Please ask about this service if you have an expedited need for a small quantity of parts.

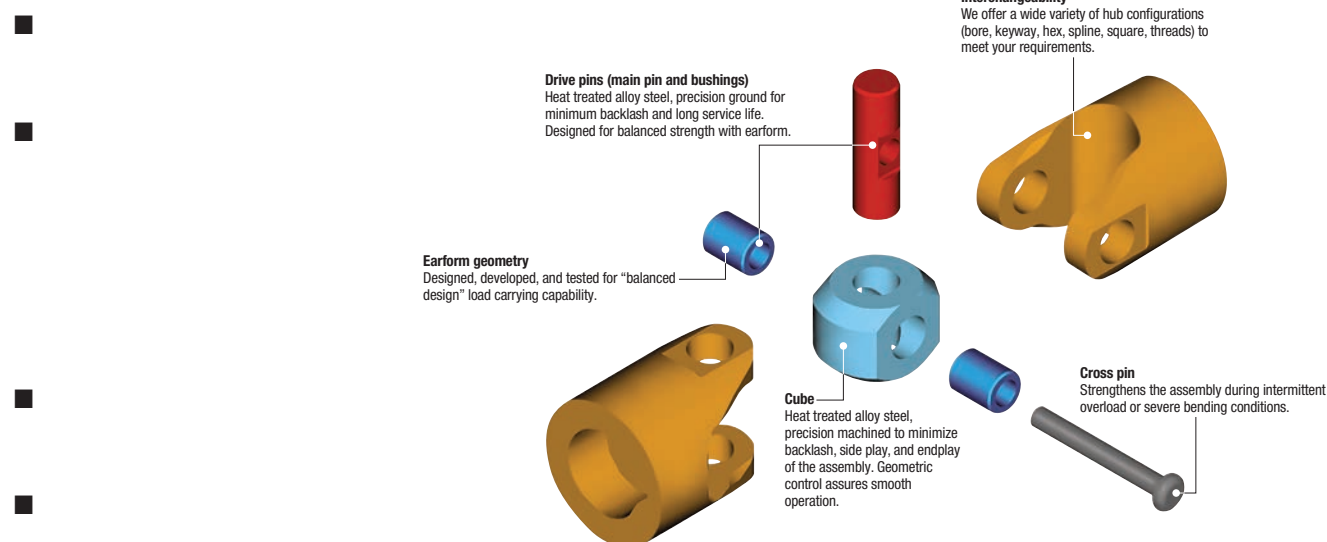

Apex has extensive in-house testing and validation capabilities.

300 Series

- Single universal joint with operating angles up to 35 degrees
- Full range of sizes from 3/8" to 2"
- Ultimate static strength up to 26,040 lbs-in
- Available with or without lubrication covers
- Standard cover supplied is Neoprene or Nitrile, others available
- Select from solid hubs, bored hubs and bores with keyways
- Hubs do not need to be the same on both ends
- Field/customer machinable alloy steel
- Plating available upon request



Note: The first number(s) after the 300 or 400 series prefix represent the outside diameter of the universal joint in 16th's of an inch. A number following this is the diameter of the bore in 16th's of an inch. If the product has a keyway it will be represented by a number following the bore size and is in 32nd's of an inch. For example, 300-20-12-6 is a 1.25" O.D. (20/16") universal joint with a .75" (12/16") bore on each end and a .188" (6/32") keyway.

Solid Hubs

300-6-S	0.375	9.5	1.750	44.4	0.093	0.042
300-8-S	0.500	12.7	1.875	47.6	0.144	0.065
300-10-S	0.625	15.9	2.188	55.6	0.233	0.106
300-12-S	0.750	19.1	2.500	63.5	0.356	0.162
300-14-S	0.875	22.2	3.000	76.2	0.508	0.231
300-16-S	1.000	25.4	3.375	85.7	0.758	0.345
300-20-S	1.250	31.8	3.750	95.2	1.247	0.567
300-24-S	1.500	38.1	4.500	114.3	2.156	0.980
300-28-S	1.750	44.4	5.000	127.0	3.125	1.420
300-32-S	2.000	50.8	5.500	139.7	4.500	2.045

Bored Hubs

300-6-4	0.375	9.5	0.250	6.3
300-8-4	0.500	12.7	0.250	6.4
300-8-6	0.500	12.7	0.375	9.5
300-10-6	0.625	15.9	0.375	9.5
300-10-7	0.625	15.9	0.438	11.1
300-10-8	0.625	15.9	0.500	12.7
300-12-8	0.750	19.1	0.500	12.7
300-12-10	0.750	19.1	0.625	15.9
300-14-8	0.938	23.8	0.500	12.7
300-14-12	0.938	23.8	0.750	19.1
300-16-10	0.938	23.8	0.625	15.9
300-20-10	1.000	25.4	0.625	15.9
300-20-12	1.000	25.4	0.750	19.0
300-24-14	1.125	28.6	0.875	22.2
300-28-16	1.250	31.8	1.000	25.4
300-32-18	1.375	34.9	1.125	28.6

Keyways

300-12-8-4	0.750	19.1	0.500	12.7	0.125	3.2	0.063	1.6
300-14-8-4	0.938	23.8	0.500	12.7	0.125	3.2	0.063	1.6
300-16-10-6	0.938	23.8	0.625	15.9	0.188	4.8	0.094	2.4
300-20-10-6	1.000	25.4	0.625	15.9	0.188	4.8	0.094	2.4
300-20-12-6	1.000	25.4	0.750	19.0	0.188	4.8	0.094	2.4
300-24-14-6	1.125	28.6	0.875	22.2	0.188	4.8	0.094	2.4
300-28-16-8	1.250	31.8	1.000	25.4	0.250	6.3	0.125	3.2
300-32-18-10	1.375	34.9	1.125	28.6	0.313	8.0	0.156	4.0

Note: Universal joint assemblies are available with different bore/keyway sizes on each hub. Many combinations are standard products. Please call for part numbers, price and availability.



Performance specifications for standard products

3/8"	276	31	500	2,224	156	18	55	6	4	0.45	1.00
1/2"	504	57	1,400	6,228	300	34	110	12	4	0.45	0.80
5/8"	960	108	2,500	11,121	576	65	190	21	4	0.45	0.64
3/4"	1,680	190	4,500	20,017	1,008	114	340	38	4	0.45	0.53
7/8"	2,520	285	7,000	31,138	1,512	171	500	56	8	0.90	0.46
1"	4,500	508	12,500	55,603	2,700	305	900	102	8	0.90	0.40
1-1/4"	7,200	813	19,700	87,630	4,320	488	1,450	164	8	0.90	0.32
1-1/2"	12,000	1,356	24,000	106,757	7,200	813	2,400	271	8	0.90	0.27
1-3/4"	15,600	1,763	29,000	128,998	9,360	1,058	3,100	350	8	0.90	0.23
2"	26,040	2,942	39,000	173,481	15,600	1,763	5,200	588	8	0.90	0.20

In addition to these standard configurations, different end configurations can be combined. Please call for additional information and pricing. Metric and special sizes available upon request. Please call or fax form at the back of catalog.

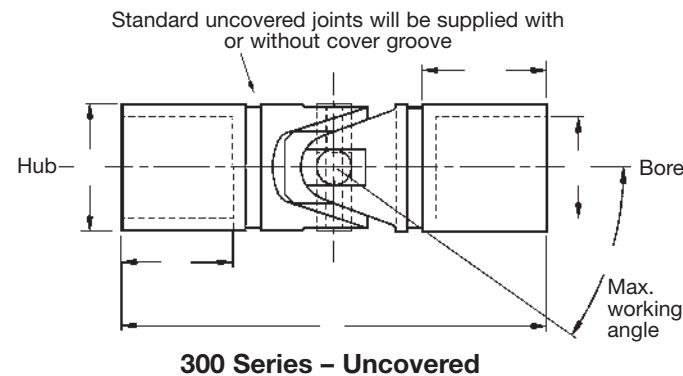

Cover Options

0.375	9.5	0.531	13.5	0.625	15.9	0.781	19.8
0.500	12.7	0.500	12.7	0.750	19.1	1.031	26.2
0.625	15.9	0.625	15.0	0.938	23.8	1.156	20.4
0.750	19.0	0.688	17.5	1.063	27.0	1.438	36.5
0.875	22.2	0.859	21.8	1.250	31.8	1.563	39.7
1.000	25.4	0.984	25.0	1.375	34.9	1.906	48.4
1.250	31.8	1.031	26.2	1.688	42.9	2.188	55.6
1.500	38.1	1.219	31.0	1.938	49.2	2.750	69.9
1.750	44.4	1.375	34.9	2.188	55.6	2.813	71.5
2.000	50.8	1.438	36.5	2.625	66.7	3.313	84.2

Add F to part number for Flat Cover.
Add C to part number for Bulbous Cover.

Metric and special sizes available upon request. Please call or fax form at the back of catalog.

400 Series

Operating angles up to 35 degrees

Sizes from 2-1/2" to 4"

Ultimate static strength up to 139,200 lbs-in

Available with or without lubrication covers

Select from solid, bored, and keyway hubs

In addition to the standard items listed, each hub can have a unique interface geometry

Available with plain bearings, bronze-sleeved bearings (field-replaceable wear item to extend universal joint life), and rolling element

Plating available upon customer request

Field/customer rebuild kits available

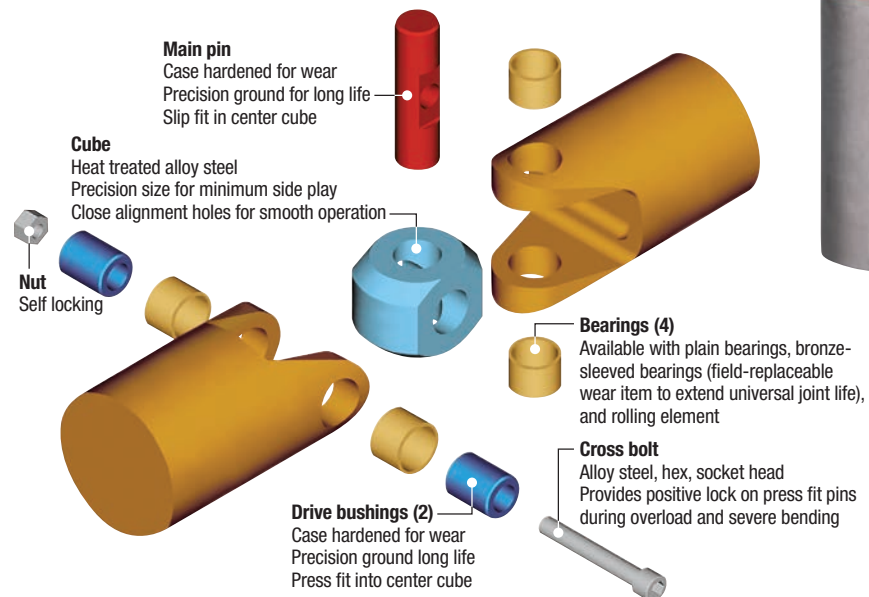

Note: The first number(s) after the 300 or 400 series prefix represent the outside diameter of the universal joint in 16th's of an inch. A number following this is the diameter of the bore in 16th's of an inch. If the product has a keyway it will be represented by a number following the bore size and is in 32nd's of an inch. For example, 300-20-12-6 is a 1.25' O.D. (20/16") universal joint with a .75" (12/16") bore on each end and a .188" (6/32") keyway.

Solid Hubs

400-40-S	2.500	63.5	7.000	177.8	9.9	4.49
400-48-S	3.000	76.2	9.000	228.6	17.8	8.07
400-64-S	4.000	101.6	10.625	269.9	35.5	16.14

Bored Hubs

400-40-24	1.750	44.4	1.500	38.1
400-48-28	2.375	60.3	1.750	44.5
400-64-32	3.000	76.2	2.000	50.8
400-64-36	3.000	76.2	2.250	57.2
400-64-40	3.000	76.2	2.500	63.5

Bored Hubs with Keyways

400-40-24-12	1.750	44.4	1.500	38.1	0.375	9.5	0.188	4.8
400-48-28-16	2.375	60.3	1.750	44.4	0.500	12.7	0.250	6.3
400-64-32-20	3.000	76.2	2.000	50.8	0.625	15.9	0.313	8.0
400-64-36-20	3.000	76.2	2.250	57.1	0.625	15.9	0.313	8.0
400-64-40-16	3.000	76.2	2.500	63.5	0.500	12.7	0.250	6.4

Covered Universal Joints

2.500	63.5	2.000	50.8	3.250	82.6	4.125	104.8
3.000	76.2	2.625	66.7	4.000	101.6	4.875	123.8
4.000	101.6	2.750	69.9	5.000	127.0	6.500	165.1

Add F to part number for Flat Cover.
Add C to part number for Bulbous Cover.

Note: Universal joint assemblies are available with different bore/keyway sizes on each hub. Many combinations are standard products. Please call for part numbers, price and availability.

Replacement Kits

UJ-Kit-2.5	2.5"
UJ-Kit-3.0	3.0"
UJ-Kit-4.0	4.0"

Replacement Kits include the following:
1-Cube, 1-Main Pin, 2-Steel Bushings,
2-Bronze Bushings, 1-Bolt with Nut

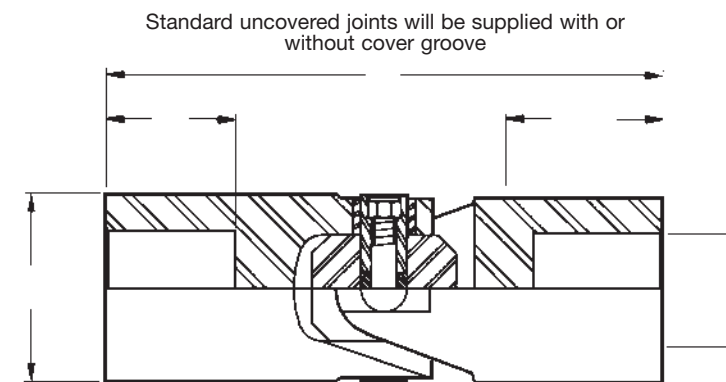

400 Series - Uncovered

400 series universal joints are available in stainless steel or coated for use in food grade and petrochemical applications. The replaceable bronze bushing facilitates visual inspection of the wear which can eliminate unplanned downtime. The replaceable components also lower the total cost associated with coupling replacement.

Performance specifications for standard products

2-1/2	38,040	4,298	54,000	240,204	22,800	2,576	7,600	859
3	61,440	6,942	75,000	333,616	36,800	4,158	12,250	1,384
4	139,200	15,728	125,000	556,028	83,500	9,434	28,000	3,164

Metric and special sizes available upon request. Please call or fax form at the back of catalog.

Metric and special sizes available upon request. Please call or fax form at the back of catalog.

Double universal joint with operating angles up to 70 degrees

Full range of sizes from 3/8" to 4"

Center hub available with bearing support

Available with or without lubrication covers

Standard cover supplied is Neoprene or Nitrile, others available

Select from solid hubs, bored hubs, and bores with keyways

In addition to the standard items listed, each hub can have a unique interface geometry

Field/customer machinable alloy steel

Available with needle bearings

Plating available upon request

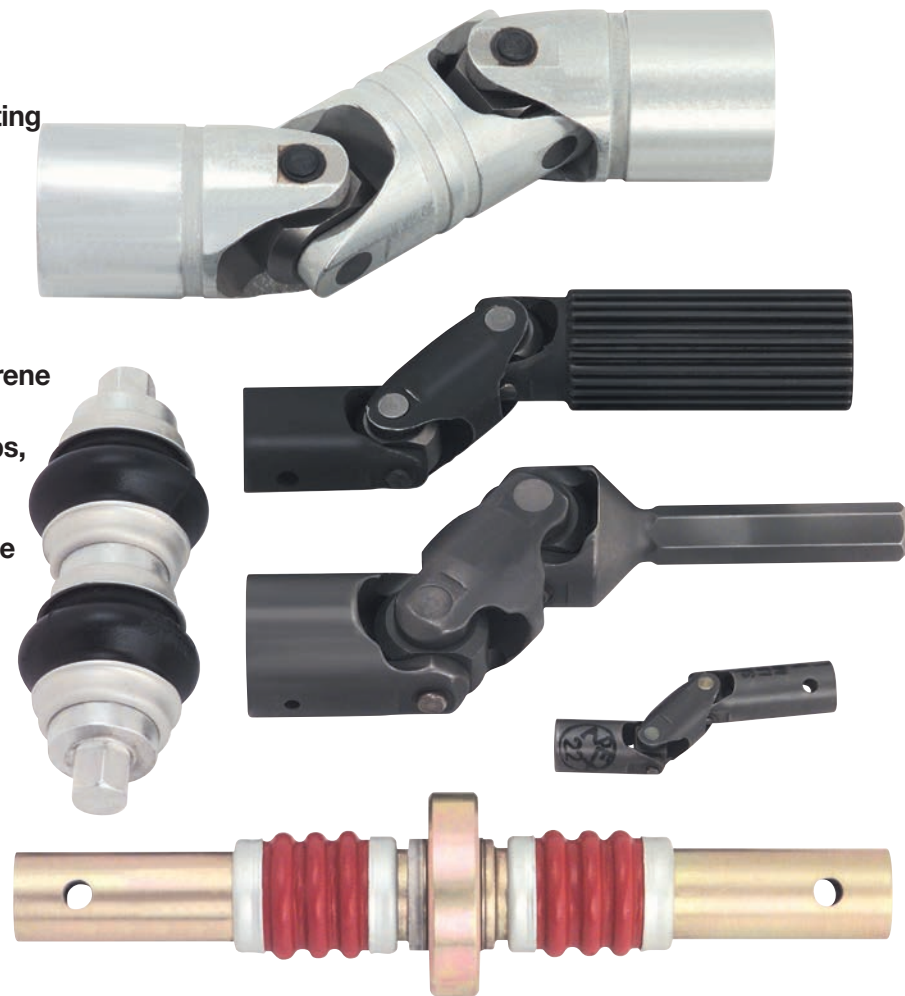

Performance specifications for standard products

3/8"	276	31	500	2,224	156	18	55	6	4	0.45	1.00
1/2"	504	57	1,400	6,228	300	34	110	12	4	0.45	0.80
5/8"	960	108	2,500	11,121	576	65	190	21	4	0.45	0.64
3/4"	1,680	190	4,500	20,017	1,008	114	340	38	4	0.45	0.53
7/8"	2,520	285	7,000	31,138	1,512	171	500	56	8	0.90	0.46
1"	4,500	508	12,500	55,603	2,700	305	900	102	8	0.90	0.40
1-1/4"	7,200	813	19,700	87,630	4,320	488	1,450	164	8	0.90	0.32
1-1/2"	12,000	1,356	24,000	106,757	7,200	813	2,400	271	8	0.90	0.27
1-3/4"	15,600	1,763	29,000	128,998	9,360	1,058	3,100	350	8	0.90	0.23
2"	26,040	2,942	39,000	173,481	15,600	1,763	5,200	588	8	0.90	0.20

Metric and special sizes available upon request. Please call or fax form at the back of catalog.

Note: The first number(s) after the 300 or 400 series prefix represent the outside diameter of the universal joint in 16th's of an inch. A number following this is the diameter of the bore in 16th's of an inch. If the product has a keyway it will be represented by a number following the bore size and is in 32nd's of an inch. For example, 300-20-12-6 is a 1.25' O.D. (20/16") universal joint with a .75" (12/16") bore on each end and a .188" (6/32") keyway.

Solid Hubs

300-D-6-S	0.375	9.5	2.625	66.7	0.875	22.2	0.875	22.2
300-D-8-S	0.500	12.7	2.938	74.6	0.938	23.8	1.063	27.0
300-D-10-S	0.625	15.9	3.313	84.2	1.094	27.8	1.125	28.6
300-D-12-S	0.750	19.1	3.813	96.9	1.250	31.8	1.313	33.4
300-D-14-S	0.875	22.2	4.500	114.3	1.500	38.1	1.500	38.1
300-D-16-S	1.000	25.4	5.000	127.0	1.688	42.9	1.625	41.3
300-D-20-S	1.250	31.8	5.563	141.3	1.875	47.6	1.813	46.1
300-D-24-S	1.500	38.1	7.000	177.8	2.250	57.1	2.500	63.5
300-D-28-S	1.750	44.4	7.875	200.0	2.500	63.5	2.875	73.0
300-D-32-S	2.000	50.8	8.750	222.2	2.750	69.8	3.250	82.5
400-D-40-S	2.500	63.5	10.500	266.7	3.500	88.9	3.500	88.9
400-D-48-S	3.000	76.2	13.750	349.2	4.500	114.3	4.750	120.6
400-D-64-S	4.000	101.6	17.000	431.8	5.313	135.0	6.375	161.9

Bored Hubs

300-D-6-4	0.375	9.5	0.250	6.3
300-D-8-6	0.500	12.7	0.375	9.5
300-D-10-8	0.625	15.9	0.500	12.7
300-D-12-8	0.750	19.0	0.500	12.7
300-D-14-8	0.938	23.8	0.500	12.7
300-D-16-10	0.938	23.8	0.625	15.9
300-D-20-12	1.000	25.4	0.750	19.0
300-D-24-14	1.125	28.6	0.875	22.2
300-D-28-16	1.250	31.8	1.000	25.4
300-D-32-18	1.375	34.9	1.125	28.6
400-D-40-24	1.750	44.4	1.500	38.1
400-D-48-28	2.375	60.3	1.750	44.4
400-D-64-36	3.000	76.2	2.250	57.1

Bored Hubs with Keyways

300-D-8-5-2	0.500	12.7	0.313	8.0	0.063	1.6	0.031	0.8
300-D-10-5-3	0.625	15.9	0.313	8.0	0.094	2.4	0.047	1.2
300-D-12-7-4	0.750	19.1	0.438	11.1	0.125	3.2	0.063	1.6
300-D-14-8-4	0.938	23.8	0.500	12.7	0.125	3.2	0.063	1.6
300-D-16-10-6	0.938	23.8	0.625	15.9	0.188	4.8	0.094	2.4
300-D-20-12-6	1.000	25.4	0.750	19.1	0.188	4.8	0.094	2.4
300-D-24-14-6	1.125	28.6	0.875	22.2	0.188	4.8	0.094	2.4
300-D-28-16-8	1.250	31.8	1.000	25.4	0.250	6.4	0.125	3.2
300-D-32-18-10	1.375	34.9	1.125	28.6	0.313	8.0	0.156	4.0
400-D-40-24-12	1.500	38.1	1.500	38.1	0.375	9.5	0.188	4.8
400-D-48-28-16	1.750	44.5	1.750	44.5	0.500	12.7	0.250	6.4
400-D-64-36-20	2.250	57.2	2.250	57.2	0.625	15.9	0.313	8.0

Covered Universal Joints

0.375	9.5	0.531	13.5	0.625	15.9	0.781	19.8
0.500	12.7	0.500	12.7	0.750	19.1	1.031	26.2
0.625	15.9	0.625	15.9	0.938	23.8	1.156	29.4
0.750	19.1	0.688	17.5	1.063	27.0	1.438	36.5
0.875	22.2	0.859	21.8	1.250	31.8	1.563	39.7
1.000	25.4	0.984	25.0	1.375	34.9	1.906	48.4
1.250	31.8	1.031	26.2	1.688	42.9	2.188	55.6
1.500	38.1	1.219	31.0	1.938	49.2	2.750	69.9
1.750	44.5	1.375	34.9	2.188	55.6	2.813	71.5
2.000	50.8	1.438	36.5	2.625	66.7	3.313	84.2
2.500	63.5	2.000	50.8	3.250	82.6	4.125	104.8
3.000	76.2	2.625	66.7	4.000	101.6	4.875	123.8
4.000	101.6	2.750	69.9	5.000	127.0	6.500	165.1

Standard uncovered joints will be supplied with or without cover groove

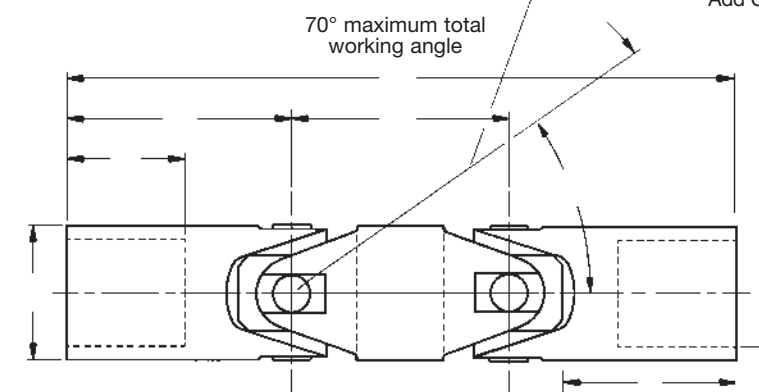

Double - Uncovered

Add F to part number for Flat Cover.
Add C to part number for Bulbous Cover.

Metric and special sizes available upon request. Please call or fax form at the back of catalog.

Make routine drive train changes and repairs faster than ever

Quick-Change design able to be replaced in seconds without tools

Eliminates the need for time-consuming alignment of motors

Telescopic feature allows for dynamic length change

Available from 3/8" to 4" diameter up to 12 feet long

Can be covered to extend service life

Also available as axially free (no spring) for fixed retention

Variety of connecting shafts available to meet application needs



Apex Telescopic/Quick-Change universal joint assemblies consist of two universal joints mounted at opposite ends of a special spring-loaded connector. Spring tension holds the assembly in driving position, yet permits instant removal by compressing one end of the assembly and lifting it clear.

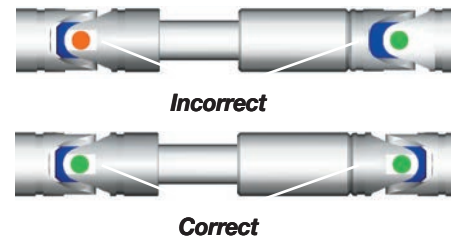
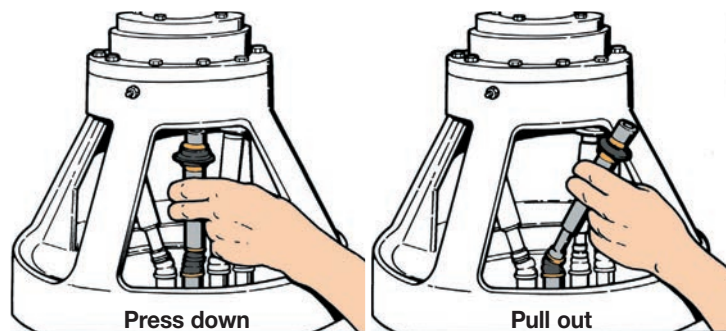

Proper alignment (as shown above in the "correct" diagram) is critical for telescopic applications.

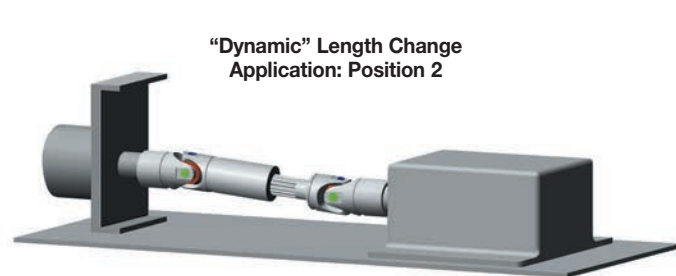
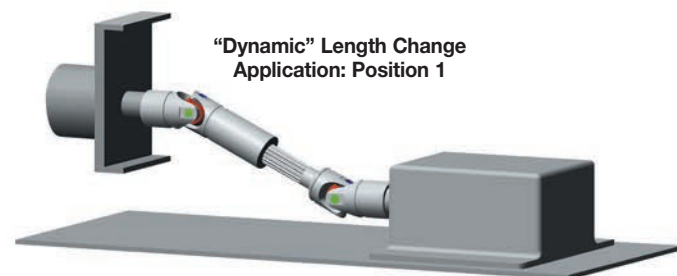

Replacement Universal Joints

10-135	Ettco Drill Head	X	C/F	5 1/4 to 4 5/8	5/16 hex	5/16 hex	5/16
10-141	Ettco Drill Head	X	C/F	7 5/8 to 5 5/16	5/16 hex	5/16 hex	5/8
10-143	Ettco Drill Head	X	C/F	7 5/8 to 6 1/16	5/16 hex	1/4 hex	5/8
10-144	Ettco Drill Head	X	C/F	5 1/4 to 4 5/16	5/16 hex	5/16 hex	5/8
10-145	Ettco Drill Head	X	C/N	5 11/32 to 4 7/16	5/16 hex	3/16 hex	5/8
10-146	Ettco Drill Head	X	C/F	5 11/32 to 4 7/16	5/16 hex	1/4 hex	5/8
10-171	Ettco Drill Head	X	C/C	7 5/8 to 5 15/16	5/16 hex	5/16 hex	5/8
14-190	Ettco Drill Head	X	C/C	8 7/8 to 7 9/16	1/2 hex	7/16 hex	7/8
14-191	Ettco Drill Head	X	C/C	7 9/16 to 8 7/8	1/2 hex	7/16 hex	7/8
14-192	Ettco Drill Head	X	C/C	7 15/16 to 9 1/16	1/2 hex	5/15 hex	7/8
UJ-130	U.S. Drill Head	X	C/F	3 29/32	14 hex	1/4 hex	5/8 x 1/2
UJ-248-E	U.S. Drill Head	X2	F	3 7/8	1/2m. Hex	3/8	5/8
UJ395AUJ395E	U.S. Drill Head	X	C/C	9 to 8 1/4	1/2 hex	1/2 hex	3/4
UJ395AUJ248E	U.S. Drill Head	X	C/F	9 to 8 1/4	1/2 hex	3/8 hex	3/4 to 5/8
UJ-193-A	Johnson Drill Head	S	C	1 7/16	1/4 hex	25/64 male	1/2
UJ-193-C	Johnson Drill Head	S	F	1 7/16	5/16 hex	1/4 hex	1/2
UJ-296-A	Johnson Drill Head	S	C	1 3/4	5/16 hex	25/64 male	5/8
UJ-296-C	Johnson Drill Head	S	F	1 5/8	5/16 hex	5/16 hex	5/8
UJ-331-A	Johnson Drill Head	S	C	2 1/2	3/8 hex	5/8 male	3/4
UJ-331-H	Johnson Drill Head	S	F	2 1/4	1/2 hex	3/8 hex	3/4
16-610-A	Johnson Drill Head	S	C	2 15/16	1/2 hex	3/4 hex	1
16-610-H	Johnson Drill Head	S	F	2 1/2	5/8 hex	1/2 hex	1
20-791-A	Johnson Drill Head	S	C	3 3/4	3/4 hex	7/8 male	1 1/4
20-791-B	Johnson Drill Head	S	F	3 3/4	3/4 hex	3/4 hex	1 1/4
10-249	Burgmaster Drill Head	X	C/C	9 13/32	1/2-20 male	7/16 male	5/8
16-060	Burgmaster Drill Head	S	C/C	18 1/2 to 17 1/2	5/8 male	5/8	1
UJ-794-A	Burgmaster Drill Head	S	C	3 3/4	5/8 hex	15/16 male	1 1/4
UJ-794-B	Burgmaster Drill Head	S	C	3 3/4	7/8	5/8 hex	1 1/4
20A-537	Burgmaster Drill Head	S	C	5	1-6B spline	1 1/4	1 1/4
20A-538	Burgmaster Drill Head	S	C	5	1-6B spline	15/32	1 1/4
32-151	Burgmaster Drill Head	S	C	5 1/2	1-6B spline	1 14/32 male	2
32-253	Burgmaster Drill Head	S	C	5 1/2	1 1/8-6B spline	1 3/8	2
UJ-1066-B	Jarvis Drill Head (lower sub assembly)	X2	N	3 5/8	3/8 m. hex	3/16 hex	3/8
10-007-B	Jarvis Drill Head (lower sub assembly)	X2	N	3 5/8	3/8 m. hex	5/16 hex	5/8
12-019-A	Jarvis Drill Head (upper sub assembly)	X1	C	3 7/8	7/16 hex	3/8 hex	3/4
12-089-B	Jarvis Drill Head (lower sub assembly)	X2	N	3 5/8	3/8 m. hex	3/8 hex	3/4
UJ-233-C	Commander Drill Head	S	C	2 17/32	5/16	3/8	5/8
12-301	Commander Drill Head	X	C/C	7 21/32 to 6 3/8	3/8 hex	3/8 hex	3/4

Cover Designations: C = Bulbous Cover F = Low Profile Cover N = No Cover
Hex Designations: Hex = Female hex M. Hex = Male Hex

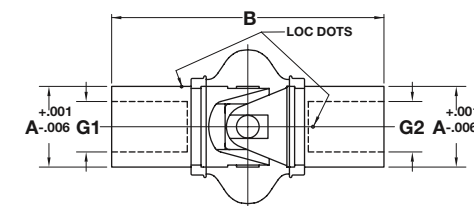

Style S

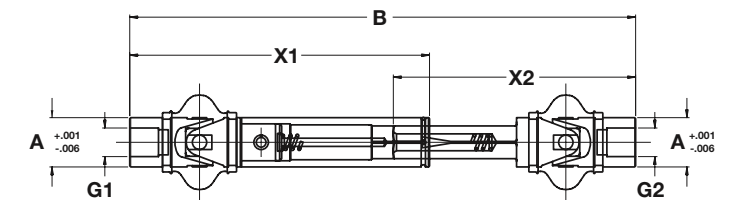

Style X

MS 270 Series

Light-duty MS 270 military standard universal joints have undergone qualification testing and meet or exceed the requirements of Military Specification MIL-DTL-6193 and Standard Drawing MS20270.

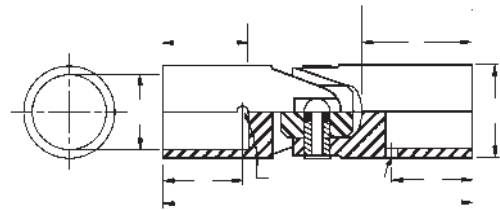

MS 270 Series



MS 271 Series

Heavy-duty MS 271 military standard universal joints have undergone qualification testing and meet or exceed the requirements of Military Specification MIL-DTL-6193 and Standard Drawing MS20271.

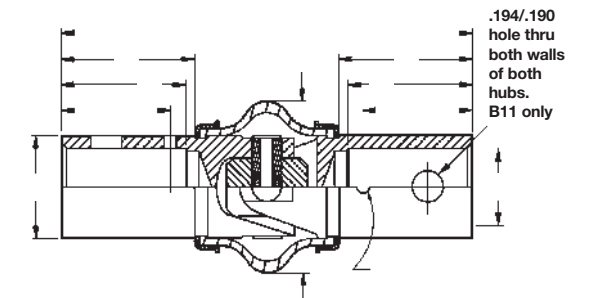

MS 271 Series

Dimensions

MS-20270-B6	0.372	9.45	1.750	44.45	0.375	9.52	0.625	15.88	0.250	6.35	0.312	7.92	0.035	0.016
MS-20270-B8	0.495	12.57	1.875	47.62	0.500	12.70	0.625	15.88	0.375	9.52	0.437	11.10	0.065	0.030
MS-20270-B10	0.620	15.75	2.187	55.55	0.625	15.88	0.750	19.05	0.500	12.70	0.562	14.27	0.095	0.043
MS-20270-B12	0.745	18.92	2.500	63.50	0.750	19.05	0.875	22.22	0.625	15.88	0.687	17.45	0.160	0.073
MS-20270-B14	0.870	22.10	3.000	76.20	0.937	23.80	1.031	26.19	0.750	19.05	0.875	22.22	0.220	0.100
MS-20270-B16	0.995	25.27	3.375	85.72	0.937	23.80	1.125	28.57	0.812	20.62	0.875	22.22	0.385	0.175
MS-20270-B20	1.245	31.62	3.750	95.25	1.000	25.40	1.187	30.15	1.062	26.97	0.937	23.80	0.630	0.286
MS-20270-B24	1.495	37.97	4.500	114.30	1.125	28.57	1.375	34.92	1.250	31.75	1.062	26.97	1.200	0.545

Performance Specifications

MS-20270-B6	0	4	0.452	1.00	175	19.78	250	28.25	200	890	15°	26	2.94
MS-20270-B8	0	4	0.452	0.80	250	28.25	480	54.24	200	890	15°	38	4.29
MS-20270-B10	0	4	0.452	0.64	500	56.50	950	107.35	300	1,335	15°	75	8.48
MS-20270-B12	0	4	0.452	0.53	1,000	113.00	1,600	180.80	400	1,779	15°	150	16.95
MS-20270-B14	0	8	0.904	0.46	1,750	197.75	2,500	282.50	500	2,224	15°	262	29.61
MS-20270-B16	0	8	0.904	0.40	2,500	282.50	4,500	508.50	600	2,669	15°	375	42.38
MS-20270-B20	0	8	0.904	0.32	5,000	565.00	7,000	791.00	800	3,558	15°	750	84.75
MS-20270-B24	0	8	0.904	0.27	7,500	847.50	11,500	1,299.50	1,100	4,893	15°	1,125	127.13

Dimensions

MS-20271-B6	0.372	9.45	2.000	50.80	0.500	12.70	0.563	14.30	0.250	6.35	0.437	11.10	0.071	19.84	0.07	0.032		
MS-20271-B8	0.495	12.57	2.625	66.67	0.625	15.88	0.688	17.48	0.375	9.52	0.562	14.27	0.103	26.19	0.09	0.041		
MS-20271-B10	0.620	15.75	2.750	69.85	0.750	19.05	0.813	20.65	0.500	12.70	0.687	17.45	1.156	29.36	0.18	0.082		
MS-20271-B11	0.620	15.75	2.750	69.85	0.750	19.05	0.813	20.65	0.500	12.70	0.687	17.45	1.156	29.36	0.312	7.92	0.18	0.082
MS-20271-B12	0.745	18.92	3.187	80.95	0.875	22.22	0.938	23.83	0.625	15.88	0.812	20.62	1.437	36.50	0.24	0.109		
MS-20271-B14	0.870	22.10	3.625	92.07	1.000	25.40	1.063	27.00	0.750	19.05	0.937	23.80	1.562	39.67	0.35	0.159		
MS-20271-B16	0.995	25.27	4.062	103.17	1.187	30.15	1.188	30.18	0.812	20.62	1.062	26.97	1.906	48.41	0.55	0.250		
MS-20271-B20	1.245	31.62	4.625	117.47	1.125	28.57	1.313	33.35	1.062	26.97	1.125	28.57	2.187	55.55	0.90	0.409		
MS-20271-B24	1.495	37.97	5.250	133.35	1.312	33.32	1.438	36.53	1.250	31.75	1.250	31.75	2.750	69.85	1.50	0.682		

Performance Specifications

MS-20271-B6	0	4	0.452	0.83	200	22.60	275	31.08	500	2,224	15°	30	3.39
MS-20271-B8	0	4	0.452	0.62	600	67.80	675	76.28	1,000	4,448	15°	90	10.17
MS-20271-B10	0	4	0.452	0.50	1,080	122.04	1,200	135.60	1,500	6,672	15°	162	18.31
MS-20271-B12	0	4	0.452	0.42	1,900	214.70	2,100	237.30	2,000	8,896	15°	285	32.21
MS-20271-B14	0	8	0.904	0.36	3,000	339.00	3,500	395.50	3,500	15,568	15°	450	50.85
MS-20271-B16	0	8	0.904	0.32	4,700	531.10	5,500	621.50	5,700	25,354	15°	705	79.67
MS-20271-B20	0	8	0.904	0.24	9,500	1,073.50	10,500	1,186.50	7,000	31,136	15°	1,425	161.03
MS-20271-B24	0	8	0.904	0.20	14,500	1,638.50	15,500	1,751.50	9,000	40,032	15°	2,175	245.78

Apex military standard universal joints are designed to strict specifications to assure unsurpassed strength-to-weight ratios, torsional and axial overload capacity and low torsional deflection. Built to withstand the most demanding conditions, Apex military standard joints require minimal maintenance; in

most cases, the original may last the service life of the vehicle or machine. Apex military standard joints are not adversely affected by fretting corrosion or Brinelling from vibration, shock loads or overloads. Available in heavy-duty 271 Series or light-duty 270 Series, Apex military standard universal joints can be ordered with or without protective lubrication covers. Consult your Apex representative for application details.

High rigidity means low deflection rates

The deflection curves below prove the axial and torsional strength of Apex military standard universal joints. You get maximum overload protection, trouble-free operation and long service life.

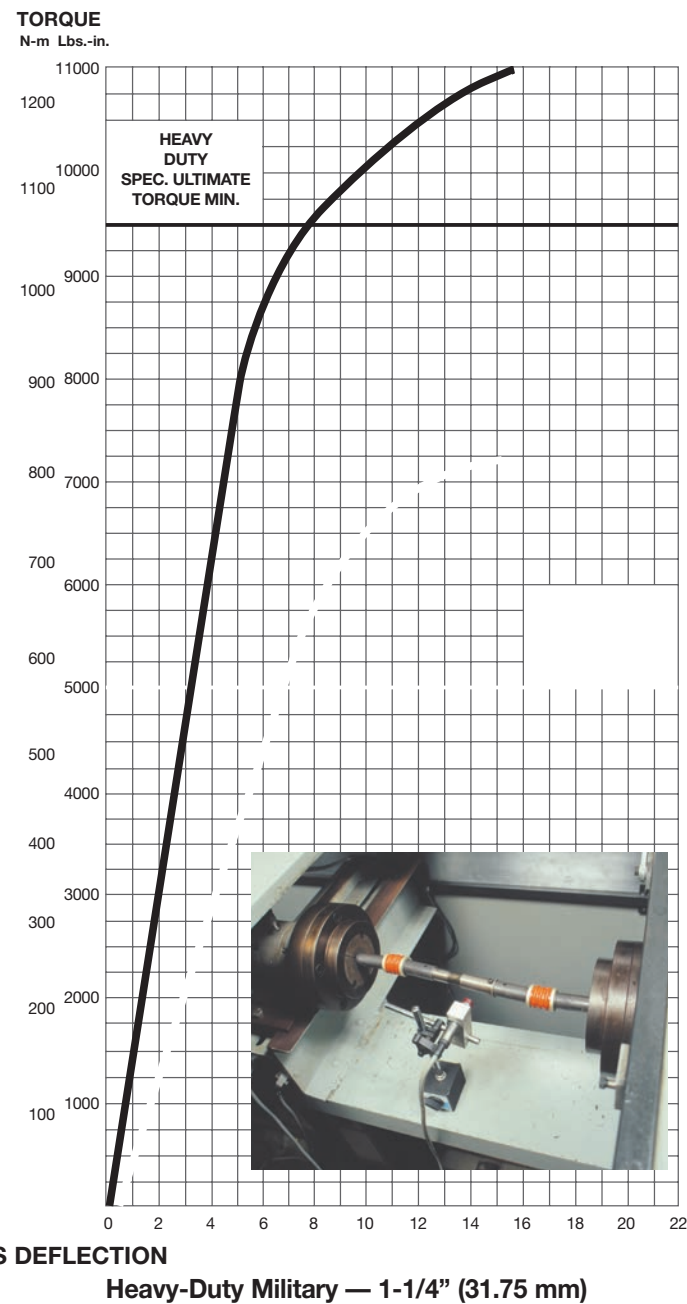
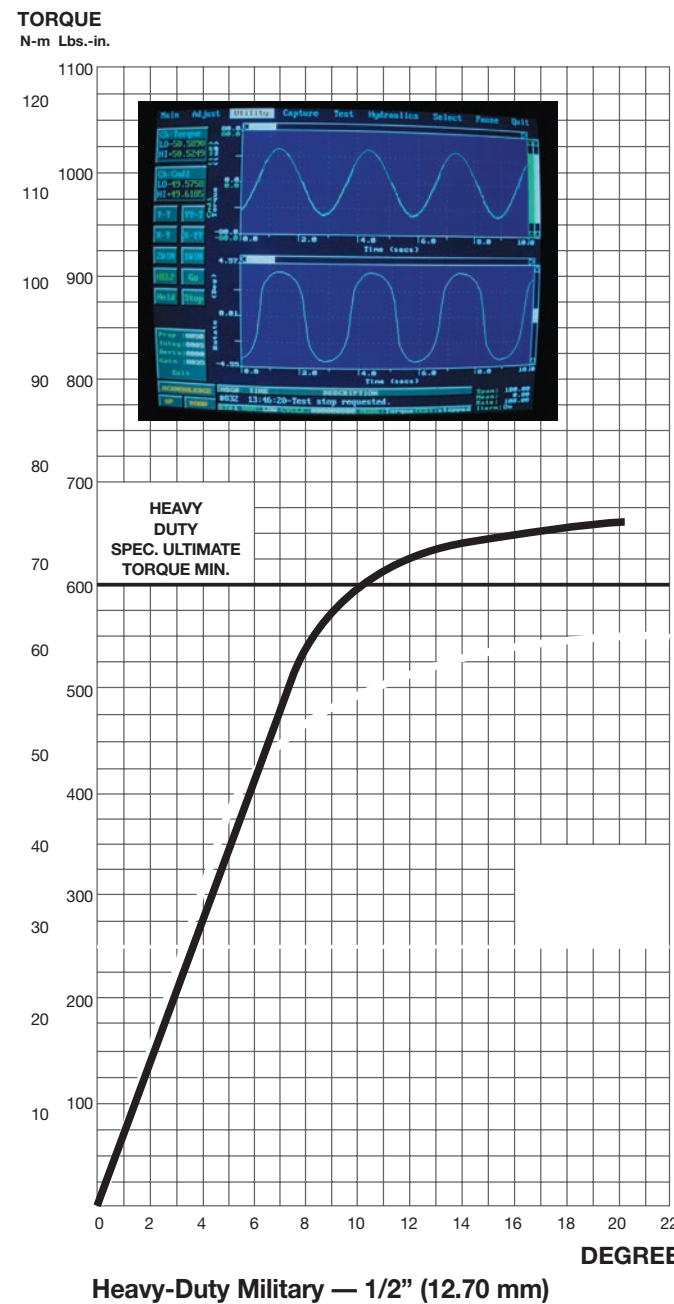

- Ideal for high capacity, critical applications**
- Hand-assembled needles eliminate torsional free-play/"Backlash"**
- Designed for continuous duty**
- Available in single, double and telescopic designs**
- Midget grease fittings in hubs allow field lubrication**
- Elastomeric cover optional for harsh environments**
- Ideal for applications over 2000 rpms**
- Meet performance requirements of SAE AS39631**
- Operating angles up to 25 degrees**
- Shaft/hub configurations designed to meet your application needs**

Bored Hub

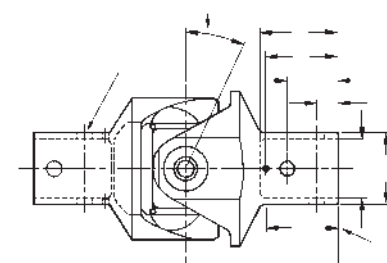
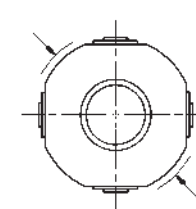

Spline Hub

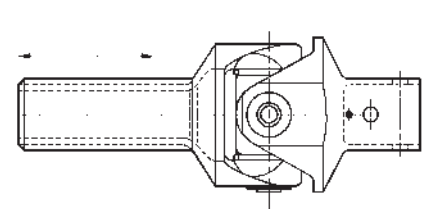
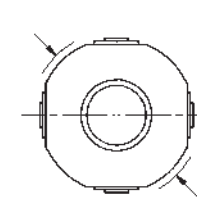

Dimensions and Specifications: Bored Hub

12A-100	1.593	40.46	0.750	19.05	0.745	18.92	1.688	42.86	0.625	15.88	0.813	20.64	0.219	5.56	0.755-19.18-0.750	0.531	13.49	0.156	3.97	0.520	0.236	1500	169.5
20A-1447*	1.938	49.23	1.125	28.58	1.245	31.62	1.750	44.45	1.062	26.97	1.063	26.99	0.312	7.92	1.005-25.53-1.000	0.688	17.48	0.219	5.56	0.800	0.362	7500	847.5

* Supercedes MS-24312

Dimensions and Specifications: Spline Hub (For Bored Hub End See Table Above A thru L)

12A-101	2.656	67.46	1.438	36.51	0.57	0.259	1500	169.5	11	0.688	17.46
20A-1448**	3.312	84.12	2.000	50.80	1.20	0.544	7500	847.5	15	0.938	23.81

**Supercedes MS-24314

1. Multiply operating speed (in RPMs) by operating angle (in degrees) to get the RPM-working angle factor (X-Axis).

Intermittent Operation Parameters:

Operating angle less than 5°: On time must not exceed 50% cycle time and cannot be greater than 5 minutes.

Operating angle 5°-10°: On time must not exceed 30% of total cycle time and cannot be greater than 4 minutes.

Operating angle greater than 10°: On time must not exceed 20% of total cycle time and cannot be greater than 3 minutes.

For Intermittent Operation:

2. Find the intersecting point between transmitted torque (Y-Axis) and RPM-working angle factor (X-Axis).
3. Choose the universal joint performance curve which is directly above the intersecting point from Step 2.

For Continuous Operation:

2. Find the intersecting point between 2 times the transmitted torque (Y-Axis) and RPM-working angle factor (X-Axis).
3. Choose the universal joint performance curve which is directly above the intersecting point from Step 2.

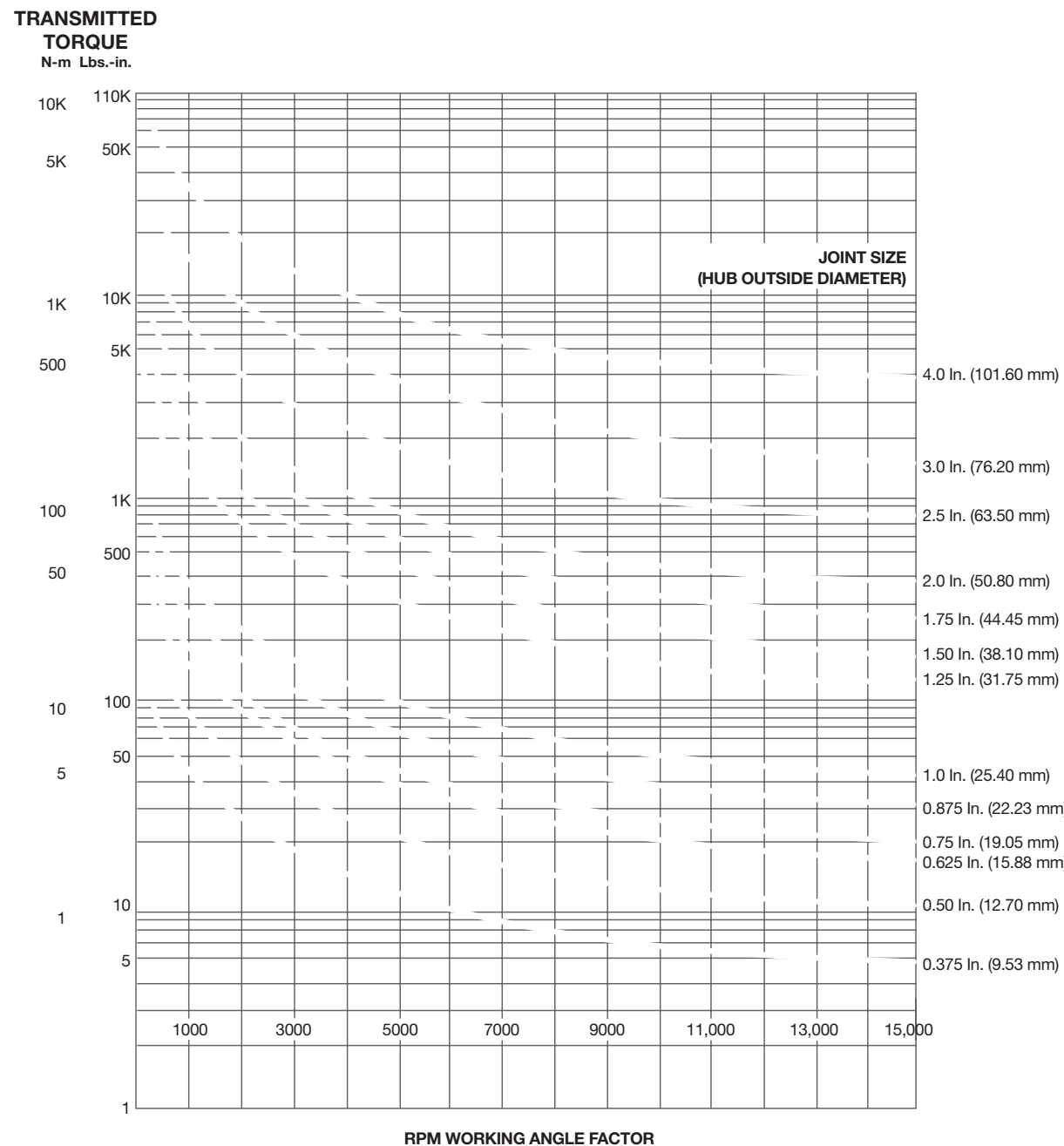

Request for information only – this is NOT an order. Important: To expedite quote, fill out form completely and FAX to 937-228-1736 or use the online form at <http://apexuniversal.com/UJquote.cfm>.

Company Name		Address		
City	State	Zip	Country	
Individual's Name	Title	Phone	Fax	e-mail

1. Application _____ Military Application? Yes No
2. Quantity to be quoted: _____
3. Nature of Operation:
 - a. Continuous: (Hours per day _____), or, Intermittent: (Time on _____ Time off _____)
Cycles per day: _____
 - b. Operating temperature: _____ Maximum _____ Minimum _____
 - b. Non-operating temperature: _____ Maximum _____ Minimum _____
4. Describe operating environment (such as corrosive, abrasive, extremes in temperature, etc.) _____
5. Horsepower transmitted by universal joint _____ or torque _____
6. R.P.M. _____ If variable, state range _____
7. Operating angle: Maximum angle required _____
8. Backlash (torsional freeplay) condition desired: Mil-J-6193 Mil-U-3963 Not Critical Other

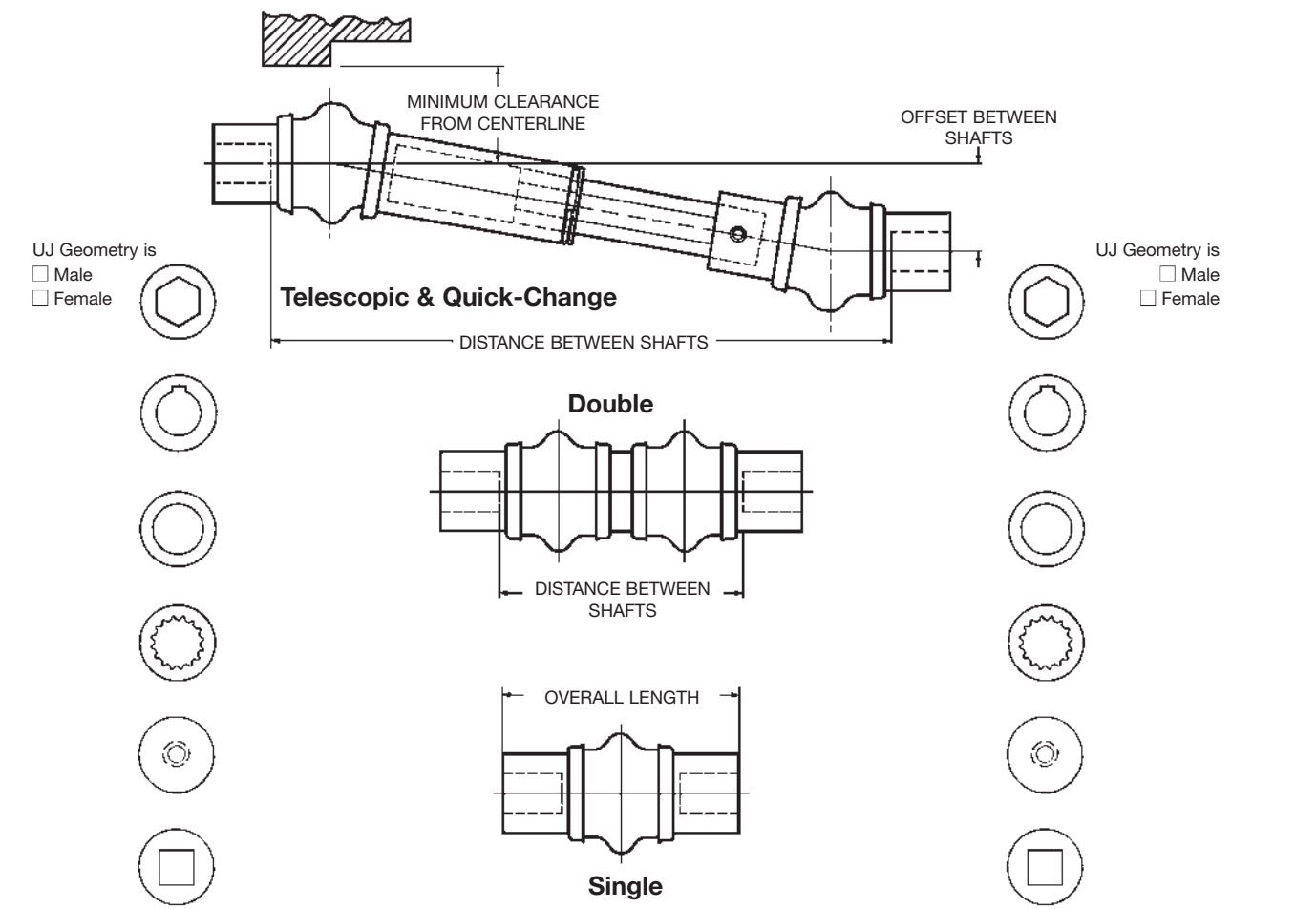

Please note that all locations may not service all products.
Contact the nearest Apex Tool Group Sales & Service Center for the appropriate facility to handle your service requirements.

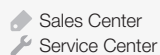

NORTH AMERICA | SOUTH AMERICA

Detroit, Michigan

Apex Tool Group
2630 Superior Court
Auburn Hills, MI 48236
Phone: +1 (248) 393-5640
Fax: +1 (248) 391-6295

Lexington, South Carolina

Apex Tool Group
670 Industrial Drive
Lexington, SC 29072
Phone: +1 (800) 845-5629
Phone: +1 (919) 387-0099
Fax: +1 (803) 358-7681

Louisville, Kentucky

Apex Tool Group
1000 Glengarry Drive
Suite 150
Fairdale, KY 40118
apexpowertools.com/service

Canada

Apex Tool Canada, Ltd.
7631 Bath Road
Mississauga, Ontario L4T 3T1
Canada
Phone: (866) 691-6212
Fax: (905) 673-4400

Mexico

Apex Tool Group
Manufacturing México
S. de R.L. de C.V.
Vialidad El Pueblito #103
Parque Industrial Querétaro
Querétaro, QRO 76220
Mexico
Phone: +52 (442) 211 3800
Fax: +52 (800) 685 5560

Brazil

Apex Tool Group
Ind. Com. Ferram, Ltda.
Av. Liberdade, 4055
Zona Industrial Iporanga
Sorocaba, São Paulo
CEP# 18087-170
Brazil
Phone: +55 15 3238 3820
Fax: +55 15 3238 3938

EUROPE | MIDDLE EAST | AFRICA

England

Apex Tool Group
GmbH & Co. OHG
C/O Spline Gauges
Piccadilly, Tamworth
Staffordshire B78 2ER
United Kingdom
Phone: +44 1827 8727 71
Fax: +44 1827 8741 28

France

Apex Tool Group S.A.S.
25 rue Maurice Chevalier
B.P. 28
77831 Ozoir-La-Ferrière
Cedex, France
Phone: +33 1 64 43 22 00
Fax: +33 1 64 43 17 17

Germany

Apex Tool Group
GmbH & Co. OHG
Industriestraße 1
73463 Westhausen
Germany
Phone: +49 (0) 73 63 81 0
Fax: +49 (0) 73 63 81 222

Hungary

Apex Tool Group
Hungária Kft.
Platánfa u.2
9027 Győr
Hungary
Phone: +36 96 66 1383
Fax: +36 96 66 1135

ASIA PACIFIC

Australia

Apex Tool Group
519 Nurigong Street, Albury
NSW 2640
Australia
Phone: +61 2 6058 0300

China

Apex Power Tool Trading
(Shanghai) Co., Ltd
Building A8, No. 38
Dongsheng Road
Pudong, Shanghai
China 201201
Phone: +86 21 60880320
Fax: +86 21 60880298

India

Apex Power Tools India
Private Limited
Gala No. 1, Plot No. 5
S. No. 234, 235 & 245
Indialand Global
Industrial Park
Taluka-Mulsi, Phase I
Hirjawadi, Pune 411057
Maharashtra, India
Phone: +91 020 66761111

Japan

Apex Tool Group Japan
Korin-Kaikan 5F,
3-6-23 Shibakoen, Minato-Ku,
Tokyo 105-0011, JAPAN
Phone: +81-3-6450-1840
Fax: +81-3-6450-1841

Korea

Apex Tool Group Korea
#1503, Hibrand Living Bldg.,
215 Yangjae-dong,
Seocho-gu, Seoul 137-924,
Korea
Phone: +82-2-2155-0250
Fax: +82-2-2155-0252

Apex Tool Group, LLC

Phone: +1 (800) 845-5629
Fax: +1 (919) 387-2614
www.apexpowertools.com